

THE

# Elks

MAGAZINE



NOVEMBER 1955

W. Snyder



# Your thirst can "feel" the difference!

When your thirst cries out for a soothing, cooling glass of finest beer, there's no refreshment like Schlitz! For here is a beer with a difference your taste can actually "feel" all the way down.

No harsh bitterness! No disappointing sweetness! Let your thirst "feel" the light, smooth, dry refreshment that really hits the spot. If you like beer, you'll love Schlitz . . . The Beer that Made Milwaukee Famous.



*Schlitz always brews  
for quality . . .  
never for price!*

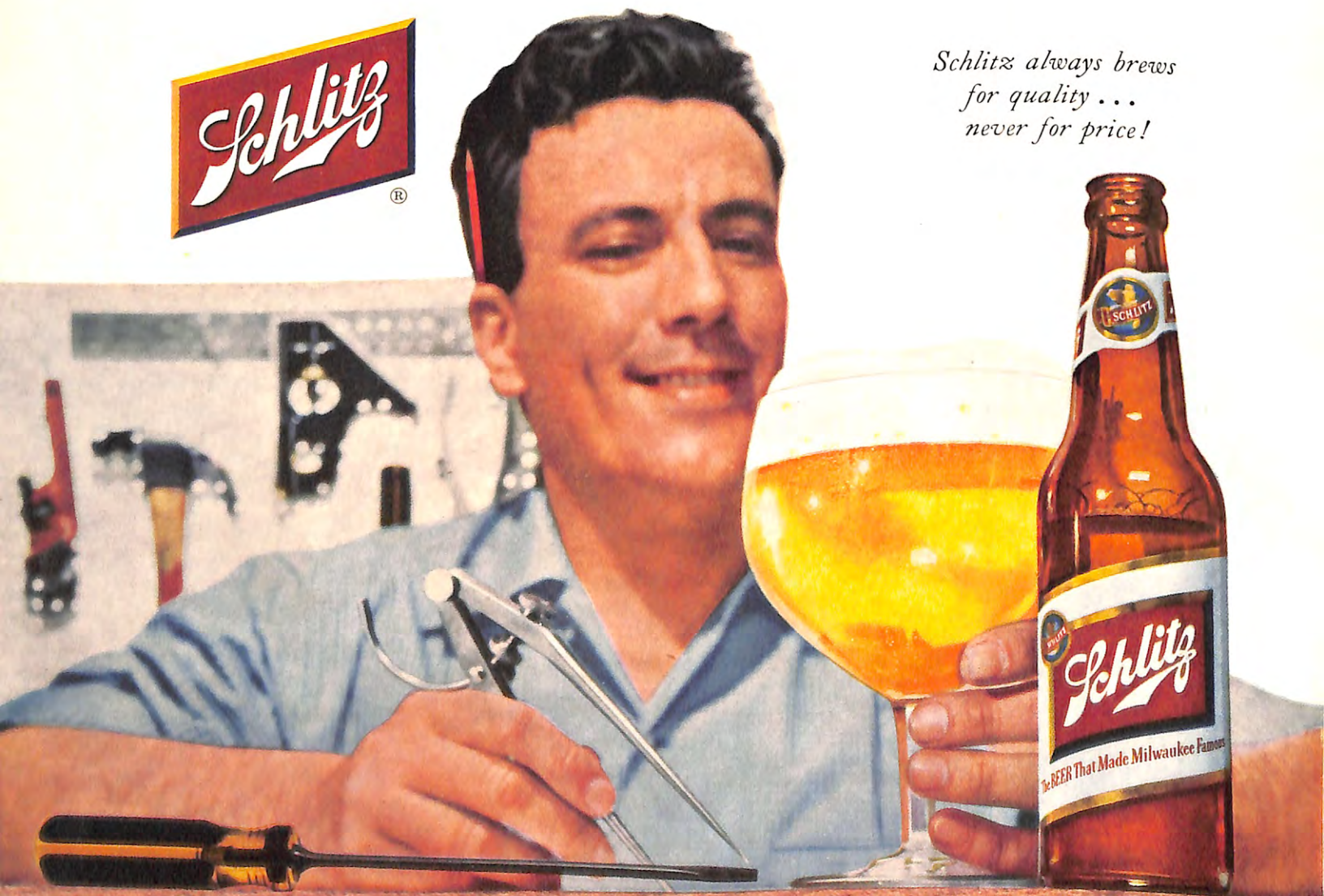



JULIE JOHNSON—Noted Merchandising Consultant selects these as the

# Prize-Winning Gift Values of 1955



## Hollywood SALADMAKER



NATIONALLY ADVERTISED AT  
~~\$19.95~~

REDUCED TO  
**\$7.95**

3 steel cutters  
DELUXE MODEL  
5 steel cutters  
~~\$9.95~~

Prize Gift Value  
No. 1

### PREPARES FOOD OVER 200 DELIGHTFUL WAYS

Now you can prepare the most beautiful, healthful foods with ease, speed, safety, and economy. Makes wonderful waffle-potatoes, tossed salad, golden brown potato chips; chops onions, peels apples, crumbs bread, prepares baby foods, health foods, and vegetable juices. Slices faster than electric machines costing \$200 or more. Easy to clean and easy to operate. Safe enough for a child to use. Recipe book included.

### GUARANTEE

We absolutely guarantee this machine to be free from defects in material and workmanship. You must be 100% satisfied or your money refunded at once.

- ✓ SHREDS
- ✓ CHOPS
- ✓ GRATES
- ✓ PEELS
- ✓ SLICES
- ✓ WAFFLES
- ✓ CRUMBS

WE PAY POSTAGE  
On Prepaid Orders

Prize Gift Value  
No. 2

## 67 PIECE Solid STAINLESS ENGLISHTOWN TABLEWARE

Guaranteed 65 Years

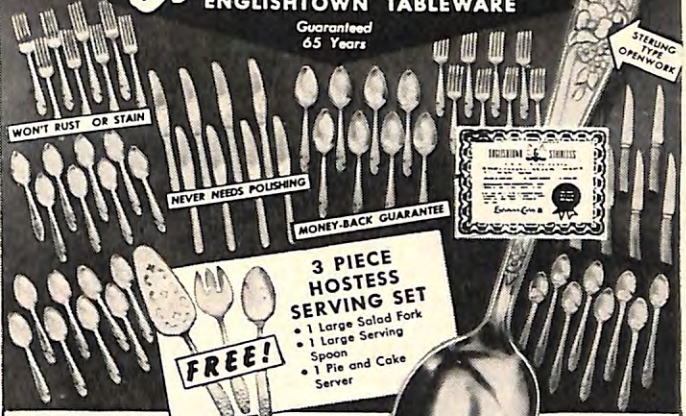

WON'T RUST OR STAIN

NEVER NEEDS POLISHING

MONEY-BACK GUARANTEE

### 3 PIECE HOSTESS SERVING SET

- 1 Large Salad Fork
- 1 Large Serving Spoon
- 1 Pie and Cake Server

FREE!

### Rich... Ornate... Gleaming... Beautiful

Permanent Mirror Finish Never Needs Polishing

Once in each generation, comes a silver pattern so beautifully proportioned, so exquisitely designed, so perfect in every detail, as this homemaker's dream. May-time embodies all the flawless characteristics of truly fine tableware from its heavy weight, one-piece forged knives, to its delicately pierced open work and deeply embossed pattern.

- 67 Piece SERVICE FOR 8 INCLUDES:
- 8—1-pc. Fergod Knives
  - 8—Forks
  - 8—Salad Forks
  - 16—Teaspoons
  - 8—Iced Tea Spoons
  - 8—Soup Spoons
  - 8—Shelfield, Hollow ground, Sarsted Steak Knives
  - 3-pc. Hostess Serving Set

REGULAR \$39.50 VALUE  
PRICE SLASHED TO **\$14.95**



Prize Gift Value  
No. 3

## GIANT INDOOR-OUTDOOR Playhouse

Now Only **\$1.98**

### RUGGED WOVEN FABRIC CONSTRUCTION

They'll have thrills and excitement galore with this fascinating playhouse made of tough, woven fabric in bright colors. Sets up instantly without tools! Use it with or without a card table. Tent pylons make the roof rigid, side flap lifts for entrance. Big enough for two, yet it conveniently folds flat for storage.

- Easily SETS UP IN SECONDS!
- ROOM ENOUGH FOR TWO!
- FOLDS FOR STORAGE

Prize Gift Value  
No. 4

## Amazing 20 in. DANCING DOLL

# Nina Ballerina

- SHE HIGH KICKS!
- SHE WALKS ON HER TOES!
- SHE DOES SPLITS!

**\$5.95**

Nationally Advertised at \$9.95

### The Year's Most Fabulous Doll!

Sensational toe-dancing Nina rises a glorious 20" on genuine Capezio ballet slippers and dances as you hold her hand. She has a petal-soft vinyl face and thick, glossy rooted Saran hair you can wash, comb and curl. Wears a genuine ballet costume—high-length hose, frothy net skirt and gleaming real lame bodice studded with sequins. Nina can sit, walk and sleep—her fully jointed body is unbreakable. Guaranteed mechanism.



ROOTED SARAN HAIR



### ORDER BY MAIL TODAY • MONEY BACK GUARANTEE

Niresk Industries, Dept. A-7  
4757 N. Ravenswood Ave., Chicago 40, Illinois.  
Please rush Julie Johnson selected items checked. Full purchase price refunded if not 100% satisfied.

NAME \_\_\_\_\_ (please print)  
ADDRESS \_\_\_\_\_  
CITY \_\_\_\_\_ ZONE \_\_\_\_\_ STATE \_\_\_\_\_  
 I enclose \$ \_\_\_\_\_ ship prepaid.

- Saladmaker with 3 Steel Cutters.....\$7.95
- Deluxe Saladmaker with 5 Steel Cutters....\$9.95
- 67 Pc. Englishtown Stainless Tableware...\$14.95
- Amazing 20 In. Dancing Doll.....\$5.95
- Giant Indoor-Outdoor Playhouse.....\$1.98 plus 25c for postage and handling.

WE PAY POSTAGE on all CASH orders  
NIRESK INDUSTRIES • CHICAGO 40, ILL.





## TOM WRIGLEY WRITES FROM WASHINGTON



**T**HIS "DO-IT-YOURSELF" business has gone so far the U. S. Navy is taking on \$10,000,000 worth of fix-upper stuff. Maybe Mr. Robert had something to do with it. Anyhow, the old steel bunks and bare port holes and grim bulk-heads are going to be dolled up and made attractive. The Navy, obviously, couldn't call in its ships for this brightening-up job, so it is sending "do-it-yourself" kits to the men at sea. They will do a bit of decorative painting here and there, fix up some chintz and curtains and make things such as backrests for bunks, hinged wall tables and nifty built-in gadgets to hold things. The Navy, never at a loss for a handy word, calls it "habitability". Far be it that tough Mr. Sailor man is getting soft. The Navy made a study of things and comes up with the conclusion that our men on the battle-wagons and other ships all down the line can't work to best advantage in drab surroundings. Just how far \$10,000,000 will go toward doing the job cannot be estimated on a "do-it-yourself" basis; neither can the number of sore thumbs and bruised fingers be counted in advance.

### STUDY ELECTION RESULTS

Local elections this November will provide few straws in the political winds to show trends in the national election a year hence. They will be studied, of course, but not taken as of national significance. The course of events in the next ten months and the personalities of the candidates themselves and their backgrounds will largely determine the results all down the line.

### ATOMIC MADE STEEL

Atomic power, when available, may bring important changes to the steel industry, U. S. Bureau of Mines reports. The industry may spread into smaller units. Iron ore may be produced by atomic power right at the iron-ore site. Electric furnace production of steel from scrap may be practical in steel consuming centers as a result of low cost atomic power produced electricity.

### DAIRY SURPLUS LOWER

Agriculture Department reports that since 1932 dairy price supports have cost

the government a staggering \$1,200,000. The situation at last is improving. Purchases of butter, cheese and dried skim milk from May to now are below those of last year. By next Spring there is hope surpluses will be reduced to a level of no "over-hanging" stocks.

### SCHOOL INSURANCE

Accident insurance for school children in Washington costs \$1.50 per child this year as against \$1.25 last. Reason is that the group insurance now covers football player insurance. Last year District high schools paid \$7,500 in football player premiums. The higher rate now includes this extra.

### IKE'S NEW AUTO

People who see President Eisenhower pass in review along the street in his new limousine stare at the odd-looking car. It has a sliding panel in the top and the President stands up in the opening and waves to the crowds. This is much more convenient than the open limousines, but, as one newsman remarked, it looks like a jack-in-the-box.

### EXPENSIVE MOSCOW

Foreign embassies in Washington own their own property and fix it up to suit their needs. They can buy anything they want at regular prices, their currency being exchanged for American money at established rates. In Moscow, however, the United States is required to rent its property at \$102,500 a year, with the ambassador's residence costing \$41,000 more in rent. The rate of exchange for American money is high, and that makes prices high.

### DIPLOMATIC DITHER

Pakistan's recently appointed ambassador to the United States has two wives and for a time State Department protocol was tied in a knot. How would you seat two wives at a diplomatic dinner? Popular Ambassador Ali, however, relieved the tension by announcing that only wife No. 2, Canadian born, incidentally, will reside with him at the Embassy. The Ambassador's first wife, however, is well and favorably known in

diplomatic circles here since she was with Mohamed Ali when he was an envoy here in 1952-53. Perhaps an exchange could be arranged later. According to Moslem law, Ambassador Ali could have four legal wives. Under diplomatic immunity, his two wives could reside at the Embassy. We have a firm friend, and one who knows diplomacy, in Ambassador Ali.

### CAPITOL VANDALISM

A major repair job is in progress on one of the Capitol's most famous paintings—"The Battle of Lake Erie." It is a huge oil—20 by 30 feet—which hangs over the marble staircase leading to the Senate gallery. Last Spring a vandal hurled a heavy object at the canvas tearing a jagged U-shaped hole in it. Painted by William H. Powell in 1873, the picture depicts Commodore Perry and a cabin boy being rowed in a small boat from the disabled flagship "Lawrence" to the brig "Niagara." That was a desperate moment in the 1813 battle but when it was over Perry sent his immortal message—"We have met the enemy and they are ours." Congress voted \$22,500 for the repair job.

### ONE FOR DAD

Census Bureau Researchers, to make Dad feel better, say a \$9,000 college education eventually pays off \$103,000. Average lifetime earnings of a college grad are estimated at \$268,000, while the high school graduate earnings average \$165,000.

### CAPITAL CHIPS

Returns on the Post Office switch to ball point pens replacing the scratchy things in use since the birth of the nation are encouraging . . . Agriculture is spending \$15,000,000 to prop up potato prices, there being a 50,000,000 bushel surplus . . . Bill collection business is growing steadily according to the American Collectors Assn. . . Uncle Sam is spending \$38,000,000 to help finance private research against disease . . . Cattle on Ike's Gettysburg farm are black Angus, but out in Colorado the cattle are mostly white-face Herefords. The President agrees the steaks are tops . . .



**Amazing  
KNEE-ACTION!**



**SHE** Can Bend Her Knees



**SHE** Sits, Walks and Stands



**SHE** Has Rooted Saran Pony Tail



NATIONALLY ADVERTISED

# ANGEL FACE

**SHE HAS LONG ROOTED SARAN HAIR!**

**SHE CAN BEND HER KNEES!**

FACTORY-TO-YOU

**\$5<sup>95</sup>**

**WALKS!  
CRIES!  
KNEELS!**

**SELLS IN STORES FOR \$15<sup>95</sup>**



- SHE ASSUMES 150 DIFFERENT POSES
- SHE'S A BEAUTIFUL 23" TALL
- UNBREAKABLE PLASTIC BODY
- GUARANTEED WALKING MECHANISM

Precious Angel Face is almost as much fun as having a real live playmate. She's 23" tall and fully jointed at knees, shoulders and hips to do just about anything her little owner wants her to. Turns her head and gaily trips along with little-miss mother, obediently holding her hand. As Angel Face stretches out her arms, you can't help kissing her irresistible, soft-as-baby-skin vinyl face. She'll sit on a chair and bend her knees when "mom" takes her up and down stairs. No need to worry if Angel Face falls, as her body is unbreakable plastic. She kicks and frolics all day, then kneels for "prayer" and closes her eyes as she's put to bed. Sweetly dressed in a frock of crisp print bodice with puffed sleeves and pink skirt. Guaranteed walking mechanism.

**23" TALL**

**Set Magic SARAN HAIR in any STYLE**



LONG DOUBLE PONY TAIL



SINGLE PONY TAIL



CORONET OF THICK BRAIDS



SOPHISTICATED BUN IN BACK

Angel Face is so proud of her long, permanently rooted Saran hair—looks just like real! Every single strand is lock stitched into her scalp so it can be washed, combed and set into any style from glamour bob to pigtailed.

©Niresk Industries, Inc., Chicago 40, Illinois.

## MONEY-BACK GUARANTEE

Niresk Industries, Inc., Dept. AF-7  
4757 Ravenswood Ave., Chicago 40, Illinois

Please rush Angel Face doll at \$5.95 plus 50c for postage and handling or C.O.D. plus postage. Full purchase price refunded if not 100% satisfied.

- Send C.O.D. plus postage.  \$5.95 plus 50c for postage and handling enclosed—ship prepaid.

NAME \_\_\_\_\_  
(please print)

ADDRESS \_\_\_\_\_

CITY \_\_\_\_\_ ZONE \_\_\_\_\_ STATE \_\_\_\_\_



# 1955-56 Grand Lodge Officers and Committeemen

## GRAND EXALTED RULER

JOHN L. WALKER, Roanoke, Va., Lodge, No. 197, Elks Home, 602 South Jefferson St.

### GRAND ESTEEMED LEADING KNIGHT

ROBERT L. DEHORRY, Elwood, Ind., Lodge, No. 368, Box 87.

### GRAND ESTEEMED LOYAL KNIGHT

ARTHUR J. ROY, Willimantic, Conn., Lodge, No. 1311, 22 Bank Street.

### GRAND ESTEEMED LECTURING KNIGHT

HAROLD J. ZIERTEN (Panama Canal Zone [Balboa], Canal Zone, Lodge, No. 1414), Box 111, Ancon, Canal Zone.

### GRAND SECRETARY

L. A. DONALDSON (Etna, Pa., Lodge, No. 932) Elks National Memorial Headquarters Bldg., 2750 Lake View Ave., Chicago 14, Ill.

### GRAND TREASURER

EDWARD A. SPRY, Boston, Mass., Lodge, No. 10, 60 Westland Ave., Boston 15.

### GRAND ESQUIRE

(To be appointed)

### GRAND TILER

M. E. MONAGLE, Juneau, Alaska, Lodge, No. 420, Box 1687.

### GRAND INNER GUARD

WALDROP WINDHAM (Homewood, Ala., Lodge, No. 1738) 312 Comer Bldg., Birmingham 3, Ala.

### GRAND CHAPLAIN

RT. REV. WILLIAM A. BROWN, Portsmouth, Va., Lodge, No. 82, 115 Washington St.

### SECRETARY TO GRAND EXALTED RULER

F. HADEN VINES, Roanoke, Va., Lodge, No. 197, Elks Home, 602 South Jefferson St.

### ACTIVITIES COORDINATOR

BERT A. THOMPSON (Green Bay, Wis., Lodge, No. 259) 2750 Lake View Ave., Chicago 14, Ill.

### BOARD OF GRAND TRUSTEES

NICK H. FEDER, *Chairman*, Belleville, Ill., Lodge, No. 481, 126a East Main Street.

ARTHUR M. UMLANDT, *Vice-Chairman and Approving Member*, Muscatine, Iowa, Lodge, No. 304, Box 17.

HORACE R. WISELY, *Secretary*, Salinas, Calif., Lodge, No. 614, 121 East Gabilan Street.

RONALD J. DUNN, *Home Member*, Oneida, N. Y., Lodge, No. 767, 324 Madison County Trust Bldg.

W. A. WALL (Building Applications), West Palm Beach, Fla., Lodge, No. 1352, Box 986.

### ADVISORY COMMITTEE

JAMES R. NICHOLSON, *Chairman*, Springfield, Mass., Lodge, No. 61.

HENRY C. WARNER, *Secretary*, Dixon, Ill., Lodge, No. 779.

EDWARD RIGHTOR, New Orleans, La., Lodge, No. 30.

BRUCE A. CAMPBELL, East St. Louis, Ill., Lodge, No. 664.

JAMES G. McFARLAND, Watertown, S. D., Lodge, No. 838.

WILLIAM H. ATWELL, Dallas, Tex., Lodge, No. 71.

CHARLES H. GRAKELOW, Philadelphia, Pa., Lodge, No. 2.

JOHN F. MALLEY, Springfield, Mass., Lodge, No. 61.

FLOYD E. THOMPSON, Moline, Ill., Lodge, No. 556.

JAMES T. HALLINAN, Queens Borough, N. Y., Lodge, No. 878.

EDWARD J. McCORMICK, Toledo, Ohio, Lodge, No. 53.

JOHN S. McCLELLAND, Atlanta, Ga., Lodge, No. 78.

E. MARK SULLIVAN, Boston, Mass., Lodge, No. 19.

FRANK J. LONERGAN, Portland, Ore., Lodge, No. 142.

ROBERT SOUTH BURRETT, Alexandria, Va., Lodge, No. 758.

WADE H. KEPNER, Wheeling, W. Va., Lodge, No. 28.

CHARLES E. BROUGHTON, Sheboygan, Wis., Lodge, No. 299.

L. A. LEWIS, Anaheim, Calif., Lodge, No. 1345.

GEORGE I. HALL, Lyndbrook, N. Y., Lodge, No. 1515.

EMMETT T. ANDERSON, Tacoma, Wash., Lodge, No. 174.

JOSEPH B. KYLE, Gary, Ind., Lodge, No. 1152.

HOWARD R. DAVIS, Williamsport, Pa., Lodge, No. 173.

SAM STERN, Fargo, N. D., Lodge, No. 260.

EARL E. JAMES, Oklahoma City, Okla., Lodge, No. 417.

WILLIAM J. JERNICK, Nutley, N. J., Lodge, No. 1290.

### GRAND FORUM

JOHN F. SCLEPPI, *Chief Justice*, (Queens Borough, N. Y., Lodge, No. 878) 41 Boulevard, Malba 57, Whitestone, N. Y.

J. PAUL KUHN, Aurora, Ill., Lodge, No. 703, Elks Club, 77 Stolp Ave.

GLEN S. PATERSON, Watertown, S. D., Lodge, No. 838, Box 1.

JOHN C. COCHRANE, Toledo, Ohio, Lodge, No. 53, 810 Spitzer Bldg., Toledo 4.

H. L. BLACKLEDGE, Kearney, Neb., Lodge, No. 984, First National Bank Building.

### COMMITTEE ON JUDICIARY

WILLIAM S. HAWKINS, *Chairman*, Coeur d'Alene, Ida., Lodge, No. 1254, 320-321 Wiggitt Bldg.

JOHN E. FENTON (Lawrence, Mass., Lodge, No. 65) Land Court, Pemberton Square, Boston 8, Mass.

A. F. BRAY (Richmond, Calif., Lodge, No. 1251) 422 State Bldg., San Francisco 2, Calif.

JAY H. PAYNE, Ann Arbor, Mich., Lodge, No. 325, Court House.

JACOB L. SHERMAN, Denver, Colo., Lodge, No. 17, 624 University Bldg.

### COMMITTEE ON CREDENTIALS

ROBERT E. BONEY, *Chairman*, Las Cruces, N. M., Lodge, No. 1119, P. O. Drawer 310.

ARTHUR J. GENIESSE (Green Bay, Wis., Lodge, No. 259) 1914 No. Prospect Ave., Milwaukee 2, Wis.

CARL R. MANN, Baytown, Tex., Lodge, No. 1649, 3214 Wisconsin St., Baytown "A".

LEWIS S. SOBER, Sunbury, Pa., Lodge, No. 267.

GEORGE D. KLINGMAN, Joplin, Mo., Lodge, No. 501, 1630 West Fourth St.

CLIFF N. OGDEN, JR., Omaha, Neb., Lodge, No. 1817, 7105 Military Ave.

LOUIS HUBNER (Union City, N. J., Lodge, No. 1357) 31 - 48th St., Weehawken, N. J.

JAMES M. VAUGHAN, Hot Springs, Ark., Lodge, No. 380, 401 Winans Ave.

RAYMOND M. GREEN, Salina, Kans., Lodge, No. 718, 324 Sunset Drive.

### COMMITTEE ON LODGE ACTIVITIES

EDWIN J. ALEXANDER, *Chairman*, (Aberdeen, Wash., Lodge, No. 593) 523 So. Sherman St., Olympia, Wash.

JAMES A. GUNN, Mamaroneck, N. Y., Lodge, No. 1457, 437 Mamaroneck Ave.

JOSEPH F. BADER, Lyndhurst, N. J., Lodge, No. 1505, 279 Travers Place.

WALTER REED GAGE, Manhattan, Kans., Lodge, No. 1185, 1840 Anderson Ave.

ROBERT G. PRUITT (Buckhead [Atlanta], Ga., Lodge, No. 1635) 808 Southern Railway Bldg., 99 Spring St., S.W., Atlanta 3.

### AUDITING COMMITTEE

SETH BILLINGS, *Chairman*, Provo, Utah, Lodge, No. 849, 330 No. Fifth St., East.

ROBERT L. PETERSON (Fargo, N. D., Lodge, No. 260) 1010 Second Ave., No., Moorhead, Minn.

FRANK D. O'CONNOR (Queens Borough, N. Y., Lodge, No. 878) 74-16 Roosevelt Ave., Jackson Heights, N. Y.

### STATE ASSOCIATIONS COMMITTEE

FRANK HISE, *Chairman*, Corvallis, Ore., Lodge, No. 1413, 455 Madison St.

WILLIAM S. WOLF, Pontiac, Ill., Lodge, No. 1019, 825 North Ladd.

J. EDWARD STAHL (Newport, Ky., Lodge, No. 273) P. O. Box 108, Fort Thomas, Ky.

VICTOR O. WEHLE, St. Petersburg, Fla., Lodge, No. 1224, Hall Bldg.

JOHN R. SCHAFF, Alexandria, Va., Lodge, No. 758, (Resigned)

CHARLES D. FOX, JR., Roanoke, Va., Lodge, No. 197, Box 534.

### RITUALISTIC COMMITTEE

EDWARD W. McCABE, *Chairman*, Nashville, Tenn., Lodge, No. 72, Box 202.

JOHN HAFICH, Minneapolis, Minn., Lodge, No. 44, 14 No. Fifth St., Minneapolis 3.

LEO P. RONAN, Decoral, Ia., Lodge, No. 443, Box 327.

CECIL M. RAPPE (Union City, Ind., Lodge, No. 1534) R.R. No. 3, Portland, Ind.

WILLIAM F. HOGAN, Everett, Mass., Lodge, No. 642, 38 Tappan St., Everett 49.

CHARLES T. NOBLE, Niles, Mich., Lodge, No. 1322, 1441 Regent St.

RONALD R. BRINGMAN (San Fernando, Calif., Lodge, No. 1539) 14355 Kittridge St., Van Nuys, Calif.

### COMMITTEE ON YOUTH ACTIVITIES

DEWEY E. S. KUHNS, *Chairman*, Charleston, W. Va., Lodge, No. 202, Second Floor, Terminal Bldg., Charleston 1.

BRIAN M. JEWETT (Bath, Maine, Lodge, No. 934) Woolwich, Maine.

W. L. HILL, Great Falls, Mont., Lodge, No. 214, 2317 Fourth Ave. South.

CHARLES C. BOWIE, San Benito, Tex., Lodge, No. 1661, 205 North Sam Houston Blvd.

GERALD L. POWELL, Peru, Ind., Lodge, No. 365, 203 West Main St.

### PENSION COMMITTEE

CLYDE E. JONES, *Chairman*, Ottumwa, Ia., Lodge, No. 347, Union Bank and Trust Bldg.

HUGH W. HICKS, *Secretary*, Jackson, Tenn., Lodge, No. 192, First National Bank.

JOHN K. BURCH, Grand Rapids, Mich., Lodge, No. 48, 217-219 Division Ave., South, Grand Rapids 2.

### NATIONAL CONVENTION COMMITTEE

GEORGE I. HALL, *Chairman*, Lyndbrook, N. Y., Lodge, No. 1515.

CHARLES H. GRAKELOW, Philadelphia, Pa., Lodge, No. 2.

JOHN S. McCLELLAND, Atlanta, Ga., Lodge, No. 78.

L. A. LEWIS, Anaheim, Calif., Lodge, No. 1345.

JAMES T. HALLINAN, Queens Borough, N. Y., Lodge, No. 878.

### NATIONAL MEMORIAL AND PUBLICATION COMMISSION

BRUCE A. CAMPBELL, *Chairman*, 7630 North Fifth Ave., Phoenix, Ariz.

JOHN S. McCLELLAND, *Vice-Chairman*, 1042 Citizens and Southern Bank Bldg., Atlanta 3, Ga.

EMMETT T. ANDERSON, *Secretary*, 756-758 Commerce St., Tacoma, Wash.

JAMES T. HALLINAN, *Treasurer*, General Court House, 88-11 Sutphin Blvd., Jamaica 35, L. I., N. Y.

WADE H. KEPNER, *Assistant Secretary and Assistant Treasurer*, 1308 Chapline St., Wheeling, W. Va.

### ELKS NATIONAL FOUNDATION TRUSTEES

JOHN F. MALLEY, *Chairman*, 16 Court Street, Boston 8, Mass.

ROBERT S. BARRETT, *Vice-Chairman*, 404 Duke Street, Alexandria, Va.

FLOYD E. THOMPSON, *Secretary*, 11 South La Salle Street, Chicago 3, Ill.

CHARLES H. GRAKELOW, *Treasurer*, Broad Street at Cumberland, Philadelphia 32, Pa.

L. A. LEWIS, Box 628, Whittier, Calif.

EDWARD J. McCORMICK, 510-511 Ohio Bank Bldg., Toledo 4, Ohio.

SAM STERN, 102 Seventh St., Fargo, N. D.

### ELKS NATIONAL SERVICE COMMISSION

JAMES T. HALLINAN, *Chairman*, Room 3257, 161 East 42nd St., New York 17, N. Y.

HENRY C. WARNER, *Vice-Chairman*, Dixon, Ill.

E. MARK SULLIVAN, *Secretary*, 209 Washington St., Boston 8, Mass.

GEORGE I. HALL, *Treasurer*, 21 West Street Building, New York 6, N. Y.

HOWARD R. DAVIS, *Assistant Treasurer*, 919 Hepburn Street, Williamsport, Pa.

FRANK J. LONERGAN, Court House, Portland, Ore.

WADE H. KEPNER, 1308 Chapline Street, Wheeling, W. Va.

EMMETT T. ANDERSON, 756-758 Commerce Street, Tacoma, Wash.

GEORGE B. KYLE, 1222 No. Pennsylvania St., Indianapolis, Ind.

WILLIAM H. ATWELL, U. S. District Court, Dallas, Tex.

CHARLES E. BROUGHTON, 920 No. Eighth St., Sheboygan, Wis.



# OUTSTANDING GIFT VALUES DIRECT FROM IMPORTER TO YOU

SAVE UP TO **50%**

YES! You can save up to 50% on the merchandise shown below—because you're buying direct from the importer. This eliminates the middleman's profit—gives YOU the benefit of BIG SAVINGS! And you buy with confidence—all items shown are offered on a 5-day trial, money-back basis. You don't risk a penny! Act now—while this once-in-a-lifetime offer lasts—send the coupon TODAY!



## 3-color POLICE FLASHLIGHT

Throws red, white & green beam!

The famous 3-Color Police Flashlight can now be yours! Police & fire departments have been ordering 'em by the carload—N.Y. City policemen alone have ordered thousands! Pushbuttons give you red, green or white beam instantly. Hi-Glo reflector increases beam intensity—visible miles away! Great for highway emergencies. Formerly sold for as much as \$5.00. ALL-METAL DESIGN.

No. 75..... 99¢

½ PRICE!  
**99c**



## POWERHOUSE BINOCULARS

Give 16 times area magnification!

**4.98** From Western Germany comes this latest model Powerhouse binocular which gives you much better viewing up to 25 miles! New model features interior fluoride coated lenses—a feature hitherto found only in expensive glasses. Gives 16 times area magnification! Hinge model—adjusts to exact space between your eyes. Handsome leather carrying case included. No distortion—you get clear, sharp images. Sorry, only one to a customer.

No. 6..... 4.98



**3.95**

**SWISS ARMY TYPE KNIFE**  
10 TOOLS IN ONE—the Swiss Army knife is recognized as the most compact multi-purpose tool ever devised. This new Korium version is the lowest price ever asked for the Swiss knife! Finest Solingen steel. Has scissors, saw, icepick, jackknife, screwdriver, awl, can opener, bottle opener, corkscrew & pen-knife. Solid Vidal handle; belt attachment. Length, 3½".

No. 88..... 3.95

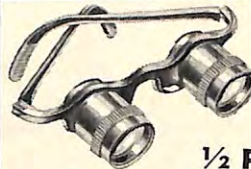

NOW ONLY **88c**

½ PRICE!

## SPECTOSCOPES

SPECTOSCOPES—the binoculars you wear like eyeglasses—are now yours for 88¢ plus 12¢ tax & delivery! Enjoy sports, TV, theatre, public events this new, thrilling way! Formerly \$2.98. You pay less than wholesale. Only TWO per customer. Weigh but 1 oz.—you hardly know you have 'em on! Clear, MAGNIFIED viewing. Individual focusing for each eye. West German make—precision optical lenses.

No. 90..... 88¢ plus 12¢

## World Famous KORIAM Hunting Knives

IDEAL GIFT for every SPORTSMAN  
HAND FORGED IN  
Solingen, Germany

YOUR CHOICE **3.95** WORTH MORE

These unique hand-forged hunting knives are made by the world renowned craftsmen of Solingen, Germany. Sharp, rugged blades are genuine KORIAM steel. Handsome unusual designs. Over 100,000 already sold here. Blades are actually sharp enough to shave with; will stand up under hardest use. Genuine leather sheaths tailored for each knife—metal tipped for straight knives. Lengths 9 to 10 inches. Tough Korium steel assures years of dependable service. Dandy gifts for men—and a sportsman's delight. Import supply limited—the low 3.95 price for both knife & scabbard means you'll have to act fast! Send the coupon today!

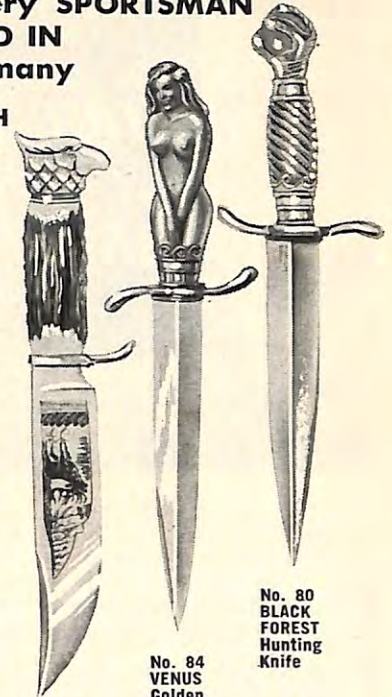

No. 80  
BLACK FOREST  
Hunting  
Knife

No. 84  
VENUS  
Golden  
Hued  
Handle

No. 82  
MONARCH  
Stag &  
Chrom  
Handle—  
Tri-Color  
Etched Blade

GIVEN:

DELUXE SHEATH OF  
GENUINE LEATHER  
TAILORED  
TO FIT

SAVE



SAVE **1.98**

GET 30 BETTER  
SHAVES FROM  
ONE BLADE!

HONIKRON—new marvel of German ingenuity—gives you 30 OR MORE SHAVES FROM A SINGLE BLADE! Hones & conditions old & new double-edge blades to an unbelievable sharpness. Does it in a few seconds—just whisk the plunger back & forth a few times and you have a factory sharp blade!

No. 3..... 1.98



**1.98**

POCKET  
MICROSCOPE  
GIVES  
**2,500**

TIMES AREA MAGNIFICATION!

Measures but 2¼ inches—but this microscope from West Germany gives GIANT POWER & PERFORMANCE! Metal design—optically ground precision lenses. Gives 2,500 times area magnification! Clear, sharp images—see Nature's wonders, examine liquids, textiles, insects, cells, stains, tissue, etc. 2 special slides given. Simple eyepiece focusing.

No. 12..... 1.98

## 17-JEWEL AUTOMATIC WATER-RESISTANT WATCH



Runs under water!

Completely shock and water-repellent! Winds itself with the movement of your arm! Hairline sweep

second hand—chromed & stainless steel case—17 jewels—Incabloc shock absorber. Accurate, durable. Formerly sold for MUCH more! Guarantee certificate and gift case included. Extremely good looking.

No. 238..... 24.95

## Mighty Midget SPY CAMERA



ONLY! **2.95**

This precision-make camera is tiny—only 2" by 1¼" Designed for detective & espionage work; can be hidden in palm of hand. Gives pictures of unbelievable sharpness! All metal, gold plated. Coated lens, speed shutter, professional viewfinder. Instant AND time settings. Snap in secret—makes great candid shots! FREE with each camera: pigskin leather case & 2 rolls of film. Special family price—3 for 7.98.

SAVE

ter, professional viewfinder. Instant AND time settings. Snap in secret—makes great candid shots! FREE with each camera: pigskin leather case & 2 rolls of film. Special family price—3 for 7.98.

No. 48..... 2.95

## SAVE MONEY WITH THIS COUPON!

THORESEN'S, Dept. 103-M-47

352 Fourth Ave., New York 10, N. Y.

RUSH the items checked on 5-Day free home trial. If not delighted with the merchandise, I will return it in 5 days for full refund. ( ) Payment enclosed. Send tax & postage paid. ( ) Send C.O.D. I'll pay charges.

- No. 75—3-Color Flashlight (99¢)
- No. 6—Powerhouse Binoculars (4.98)
- No. 82—Monarch Hunting Knife (3.95)
- No. 84—Venus Hunting Knife (3.95)
- No. 80—Black Forest Hunting Knife (3.95)
- No. 12—Pocket Microscope (1.98)
- No. 90—Spectoscopes (1.00)
- No. 3—Honikron Blade Sharpener (1.98)
- No. 88—Swiss Army Type Knife (3.95)
- No. 238—17-Jewel Automatic Watch (24.95)
- No. 48—Spy Camera (2.95)

NAME .....  
ADDRESS .....  
CITY ..... STATE .....

CANADIANS: Save tariff. Order direct from Thoresen Ltd., Dept. 45 St. James St. W, Montreal 1, P.Q.



# *A Message from the Grand Exalted Ruler*



## PLAN ELKDOM'S PROGRESS

ELKDOM is on the march. It has been my privilege to attend lodge and State Association meetings from Maine to California. Everywhere I found countless, enthusiastic Elks vitally interested in Elkdom's dynamic tenets and determined as never before to "Serve Elkdom—Live Elkdom."

These two things have impressed me most:

- 1. The marvelous humanitarian services Elks everywhere are rendering to the less fortunate and*
- 2. How little so many of our members know of the wonderful work their lodge, State Associations and the Grand Lodge are doing. We should not hide our many and varied accomplishments. On the contrary, we should make them better known, not only to the public but also to our own members. In fact, we need to sell Elkdom to Elks. To do so will help to solve our membership control problem.*

Immediately following the disastrous flood in New England and Pennsylvania, Elks responded to the call of humanity in typical Elk fashion. They promptly rendered outstanding relief work, giving generously of their time, talents and possessions. Clothing and food were furnished by Elk lodges and State Associations. Many Elks opened their homes to the sufferers and lodges were used as relief headquarters. This was Elkdom in action.

The demands were so great that I issued an appeal to lodges in the unaffected areas for financial assistance. I thank all that responded so promptly.

This month we are initiating into our Order thousands of fine American citizens in "Plan Elkdom's Progress Class". We will make them better citizens and they will enable us to expand our helpfulness. Unfortunately, however, many of us have friends and neighbors who would make good Elks but who are not joining us simply because we fail to invite them. Let's get their applications now and, in getting new members, let us not forget that now is the time for lodge Secretaries and Lapsation Committees to take the necessary action to decrease the number of delinquents.



All lodges are making plans for beautiful Memorial Services for the first Sunday in December. Also in December the lodges will observe Elks National Foundation Night. I hope that every lodge will have a fund-raising project for the Foundation.

Earlier than that comes our traditional Thanksgiving Day, which this year falls in Elk sponsored "Know Your America Week". The theme of this patriotic week is "Consider the blessings of freedom", and that is most appropriate. Freedom is so much a part of our daily lives that we are too inclined to take it for granted. Let us take inventory of freedom's blessings, of the privileges and responsibilities that are ours, because we are citizens of the United States and members of the Order of Elks. It is my prayer that Almighty God will cause us to be thankful as our forefathers and breathe the spirit of Thanksgiving into the hearts of all of us—not just for the week but for all the weeks of our lives.

*What a glorious privilege it is to be an Elk! And so with the privilege of being an Elk, there is also a duty to Serve Elkdom—Live Elkdom.*

*John L. Walker*  
GRAND EXALTED RULER



# NEWS! . . . FROM THE *FORWARD LOOK '56*



**NEWS IN THE FLIGHT SWEEP!** . . . The year's freshest and truest new note in car design. In one clean sweep from headlights to up-swept tail, it clearly and unmistakably wraps up the whole idea of *GO!* Accenting the low, long, ground-hugging mass of the car . . . here's the design that looks completely like today, and points clearly to tomorrow, too!

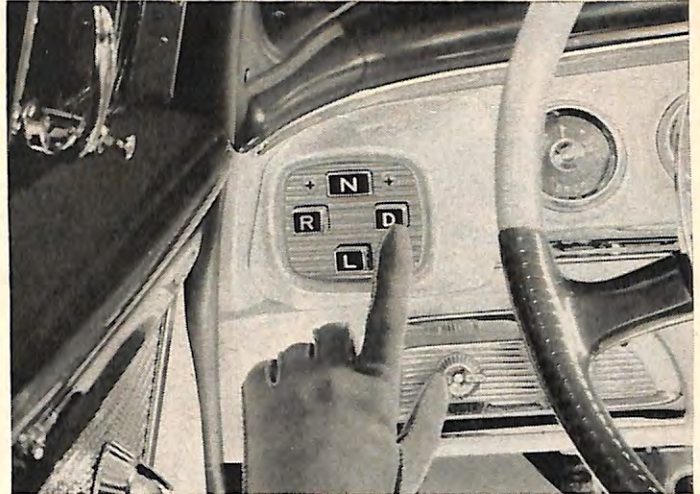

**NEWS IN PUSHBUTTON POWERFLITE!** . . . Newest driving advance of the year! Put your finger on a button on the dash at your left for whatever driving range you want. *Only the driver can touch it.* Safe and convenient as never before. And remember . . . PowerFlite itself gives the finest blend of smoothness and swiftness among *all* automatic transmissions!



**NEWS IN WONDERFUL SAFETY!** . . . Brand new Life-Guard door latches that hold fast under stress as none have ever done before. Chrysler Corporation bodies and frames, strongest and most rigid built. The finest, most responsive Power Steering, Power Brakes and engines on the road. And Safety Seat Belts, if you wish, that meet official airplane specifications!

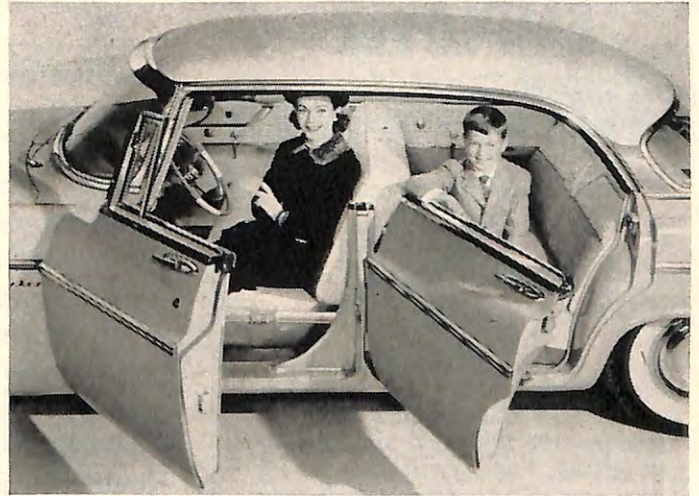

**NEWS IN 4-DOOR HARDTOPS!** . . . Now in Plymouth, Dodge, De Soto, Chrysler and Imperial! . . . *finest and most rugged cars of all in this newest body style!* The dashing, long, low line of the true hardtop . . . *but with full 4-door convenience.* Full side vision, with *full-width* rear doors and exclusive *full-width* rear windows in these cars of THE *FORWARD LOOK!*

**THE BEST NEW CAR NEWS** you'll find this year is in the cars of THE *FORWARD LOOK '56* . . . *no matter what the price range!*

Here are cars that are full of new advances. Cars that *bring things to you* other cars do not yet have. Cars that *do things for you* other cars are not yet able to do.

Here are cars so new and so wonderful

to own you'll feel a new kind of pride when you get one. Cars that literally make driving or riding a new kind of joy and satisfaction.

Right now, well over a million families own 1955 cars of THE *FORWARD LOOK* from Chrysler Corporation. These owners tell us they have discovered a motoring experience that simply cannot be found anywhere else today. And

now comes the *second* year of challenge from THE *FORWARD LOOK*. *Now, for '56, the differences between these cars and all others become sharper still!*

The new Dodge is already on display. Plymouth, De Soto, Chrysler and Imperial soon will be. Watch for the announcements. See them at your dealer's. *There's good news for you in these cars!*



**CHRYSLER CORPORATION**  
PLYMOUTH · DODGE · DE SOTO · CHRYSLER · IMPERIAL



# WHAT BETTER TIME THAN NOW



...to help everybody in  
your organization enjoy  
the many benefits of

## NEW YORK LIFE'S EMPLOYEE PROTECTION PLAN

- ★ *Life Insurance!*
- ★ *Weekly Indemnity!*
- ★ *Hospital and  
Surgical Benefits!*

Firms with as few as 10 employees are eligible for this insurance plan, designed to offer comprehensive protection and to round out existing programs. For even if you already have some form of protection, your present plan may go only part way.

An Employee Protection Plan offers a flexible combination of benefits for yourself, your employees and dependents if desired. Cost is low and the plan is simple to install as well as to administer. Ask your New York Life agent for details now—in time to make it a memorable holiday for your employees.

Write: New York Life Insurance Company, Dept. EK-2, 51 Madison Avenue, New York 10, N. Y.

**NEW YORK LIFE**  
INSURANCE COMPANY

A Mutual Company  Founded in 1845

The New York Life Agent in  
Your Community is a Good Man to Know

# THE Elks MAGAZINE

VOL. 34

MAGAZINE

No. 6

NATIONAL PUBLICATION OF THE BENEVOLENT AND PROTECTIVE ORDER OF ELKS OF THE UNITED STATES OF AMERICA. PUBLISHED UNDER THE DIRECTION OF THE GRAND LODGE BY THE NATIONAL MEMORIAL AND PUBLICATION COMMISSION.

THE ELKS NATIONAL MEMORIAL AND PUBLICATION COMMISSION

BRUCE A. CAMPBELL  
Chairman

JOHN S. McCLELLAND  
Vice-Chairman

JAMES T. HALLINAN  
Treasurer

EMMETT T. ANDERSON  
Secretary

WADE H. KEPNER  
Asst. Secy. and Asst. Treas.

JAMES R. NICHOLSON  
General Manager

LEE C. HICKEY  
Editor

REGINA M. FISHER  
Associate Editor

JOSEPH C. JONES  
Art Editor

GENEVIEVE G. CONOVER  
Advertising Production

W. H. MAGRATH  
Controller

JOHN SCHMITT  
Circulation Manager

EDWARD FAUST  
Promotion Manager

EDITORIAL OFFICES, 50 East 42nd Street, New York 17, N. Y.

## CONTENTS FOR NOVEMBER, 1955

COVER BY WESLEY SNYDER

TOM WRIGLEY WRITES FROM WASHINGTON.....	2
1955-1956 GRAND LODGE OFFICERS AND COMMITTEEMEN....	4
A MESSAGE FROM THE GRAND EXALTED RULER.....	6
REPORT FROM FORMOSA (Part II).....	Bruno Shaw 10
NEWS OF THE STATE ASSOCIATIONS.....	12
A TIME TO REMEMBER.....	National Service Commision 14
PAST GRAND EXALTED RULER BRUCE A. CAMPBELL.....	15
SANDERS OF UCLA.....	Tom Siler 16
FOR ELKS WHO TRAVEL.....	Horace Sutton 18
DISTRICT DEPUTY CONFERENCES.....	20
VISITING THE LODGES WITH JOHN L. WALKER.....	21
NEWS OF THE LODGES.....	22
ROD AND GUN.....	Ted Trueblood 24
ELKS FAMILY SHOPPER.....	26
IN THE DOGHOUSE.....	Ed Faust 44
TRAVELGUIDE.....	53
ELKS NATIONAL FOUNDATION—"Joy of Giving".....	56
ELKS WORKSHOP.....	Harry Walton 62
EDITORIAL.....	64



ADVERTISING OFFICES



CHICAGO 1  
360 North Michigan Avenue  
STATE 2-6662

NEW YORK 17  
50 East 42nd Street  
VANDERBILT 6-4660

LOS ANGELES 17  
1709 West 8th Street  
DUNKIRK 8-5187

DETROIT 2  
2970 West Grand Boulevard  
TRINITY 5-7026

SAN FRANCISCO 4  
927 Mills Building  
EXBROOK 2-4073

PORTLAND 4, ORE.  
405 Times Building  
MITCHELL 4-4266

CHANGE OF ADDRESS: POSTMASTER—Please mail Form 3579 notices to: THE ELKS MAGAZINE, 50 East 42nd Street, New York 17, N. Y.

Members are asked, in changing address, to send this information (1) Name; (2) Lodge number; (3) Membership Number; (4) New address; (5) Old address. Please allow 30 days for a change of address to be effected. THE ELKS MAGAZINE, Volume 34, No. 6, November, 1955. Published monthly at McCall Street, Dayton, Ohio by the Benevolent and Protective Order of Elks of the United States of America. Entered as second class matter November 2, 1940, at the Post Office at Dayton, Ohio, under the Act of August 24, 1912. Acceptance for mailing at special rate of postage provided for in Section 1103, Act of October 3, 1917, authorized May 20, 1922. Printed in Dayton, Ohio, U.S.A. Single copy price, 20 cents. Subscription price in the United States and its Possessions, for Elks \$1.00 a year; for non-Elks, \$2.00 a year; for Canadian postage, add 50 cents a year; for foreign postage, add \$1.00 a year. Subscriptions are payable in advance. Manuscripts must be typewritten and accompanied by sufficient postage for their return via first class mail. They will be handled with care but this Magazine assumes no responsibility for their safety. Copyright, 1955, by the Benevolent and Protective Order of Elks of the United States of America



## What Our Readers

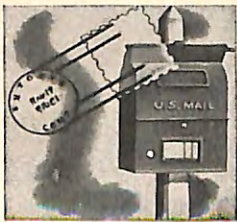

## Have to Say

Thank you for the splendid information and maps which we received from your Travel Department. We are very grateful and know that we cannot get lost with such well planned maps. We think that the Elks Magazine travel service is to be commended for the information that it provides.

Mrs. Clarence E. Wittig  
Bisbee, Ariz.

I certainly enjoyed the article about Formosa by Bruno Shaw which ran in September Elks. We need more writers with more information along these same lines. With the vast store of information that Mr. Shaw has at hand, I am wondering what might be the cost, and where might be obtained, a pedicab? This may be a useless question, but if available I sure would like the information.

Jerry N. Hinshaw  
Hutchinson, Kan., Lodge

*Far from being a useless question, Brother Hinshaw's request aroused Mr. Shaw's interest and he tells us that he would like to know too and has written to friends on Formosa to find out where, and how, a pedicab can be bought.*

I always look forward every month to my Elks Magazine to see what there is new in Elks Workshop. I read my Magazine from cover to cover and, being retired with time on my hands, particularly appreciate the Workshop.

August C. Burkhardt  
Sandusky, Ohio, Lodge

As a regular reader of your magazine I wish to call your attention to an interesting pair of facts in connection with Tom Wrigley's "last name in the phone book" item in your August issue. I have been told that the last name in the Los Angeles phone book is spelled "ZZYZZ" and I have seen that the last name in the Detroit phone book is, "Believe It or Not," spelled "ZZZPT." I think it most likely that this will end the last name business.

Maurice P. Babcock  
Springfield, S. D.

The literature that your Travel Department sent relative to our trip to St. Petersburg, Florida, has been received. The Sinclair Oil Company, in response to your request, has forwarded the maps that we will need. I wish to thank you for your prompt attention to this matter. You have a splendid service that adds one more reason why it is good to be a member of the BPOE.

Dr. C. W. Sheridan  
Rochester, N. Y.

# Full Power Starts

## Presto-lite

### HI-LEVEL BATTERIES

*Chuck Conerly*

Brilliant New York Giants back who holds the NFL record for 36 passes completed in one game says, "The Presto-lite Hi-Level Battery in my car gives full power, dependable starting every time."



**needs water  
only 3 times  
a year\*...  
lasts longer, too!**

\*IN NORMAL CAR USE

**SEE YOUR PREST-O-LITE DEALER**



# REPORT FROM FORMOSA



Elks Magazine reporter Bruno Shaw interviews Vice President Chen Cheng of the Republic of China at the V.P.'s home in Taipei. Mr. Chen is largely responsible for the land reforms that brought farmer prosperity to Formosa.

## Agricultural, political and social reforms mark progress on Formosa.

**I**N THE FIRST of these two articles \*reporting on my trip to Formosa sponsored by The Elks Magazine, I presented the substance of my interviews with President Chiang Kai-shek and other leading officials of the Republic of China. They revealed the determination of the Nationalist Government to launch a military expedition against the Red rule of Peiping to be timed with an uprising of the Chinese people on the mainland.

In this second article I shall describe the resources the Nationalist Government has developed on Formosa, and the agri-

cultural, political and social reforms that have been put into effect, which give Nationalist leaders hope that their goal may be achieved.

The island of Formosa lies slantwise across the west Pacific, its nearest point only about a hundred miles from the mainland of China. It is about 14,000 square miles in area, approximately the size of our states of Massachusetts and New Jersey combined. The difference between them, however, is that while both these states lend themselves to a well distributed population with unrestricted opportunity for agricultural and industrial development, Formosa is three-quarters forest covered mountain, and

only one-quarter arable and inhabitable lowland.

The Pescadores, lying thirty miles westward and generally considered a unit with Formosa, are a group of small, flat islands, which seem for all the world like irregularly shaped pancakes floating on the surface of the blue Formosa Strait. Flying over their intensely cultivated, checkerboard surface, they seem even tinier than the fifty square miles the surveys assure us they are.

No matter where you stand on Formosa, you are overshadowed by vast mountain ranges. From one end of the island to the other, from north to south, their massive peaks, towering as high in some places as 11,000 feet, wall the lowlands in the west from the broad Pacific to the east. There is no access from one to the other. To travel from Taichung on the central west coast to Hualien on the east, one has to go by road all the way around the island, either north or south.

Chinese immigration to Formosa began some three hundred years ago, mostly from Fukien, the province directly west across the Strait. In 1895, at the end of the Sino-Japanese War, the island was ceded to Japan. For fifty years, until the end of World War II, Japan held it as a colonial possession. With rare exceptions, its people were restricted in education to six years of elementary grade schooling, and to menial and subordinate jobs in government and industry. At the end of World War II, the 250,000 Japanese residents in Formosa were repatriated to Japan. In the winter of 1949 the

\*Refer to September issue.

### PART II

### BY BRUNO SHAW

Bruno Shaw, who in recent years has contributed several articles exposing various facets of communism's tactics, was formerly publisher of a newspaper in Hankow. This article, in conjunction with Part I in our September issue, is the result of his observations during a visit to Formosa late last summer.



seat of the government of the Republic of China withdrew to the island from the mainland; and today Formosa has a population of some eight million native Chinese Formosans, and two million voluntary exiles, about one quarter of whom are in the armed forces.

The Republic of China, generally spoken of in the West as the Nationalist Government, has dedicated itself to creating in Formosa the "show-case" economy it was in the process of developing on the mainland when it was overthrown by the Reds with Soviet aid. Because of the weakened state of the nation, after eight years of war against Japan and Communist subversion, the program on the mainland proceeded too slowly to enable it to become an effective bulwark against Red undermining and aggression.

In Formosa, the Republic's Vice President Chen Cheng was determined that there should be no procrastination in overcoming the major problem that for many decades had been a source of misery for the majority of the Chinese people—redistribution of the land so that the farmers, the majority of whom have been sharecroppers, may own the land they cultivate.

To the Chinese people, of whom as high as 80 per cent on the mainland, and 54 per cent on Formosa, are farmers, a land reform such as this spells the difference between poverty and prosperity; and the difference between a buying power on the part of the majority of the people that would spur business and industry, and economic stagnation. No such advances could take place as long as the tenant-farmer had to pay as high as 65 per cent to 70 per cent of his crop in land rent, interest and taxes. And the Nationalist Government's attempt to reduce this by legislation to 25 per cent, in 1947, was too little and too late.

Similar tenant-farmer conditions, prevalent in many countries in the Far East, existed in Formosa when the Nationalist Government first arrived there in 1949.



The changes that have been wrought since then by a three-cornered cooperative venture by landowners, tenants and government, are striking and profound. They have in all respects made Formosa the "show-case" of land-to-the-tiller programs wherever they may be needed, in the Far East or elsewhere.

During my stay in Formosa, I visited factories, agricultural and health stations, travelled the highways, the railroad, and by air, and accompanied by government engineers inspected the water conservation and hydroelectric projects already built and those under construction.

The most important and undoubtedly the most spectacular of all the programs  
*(Continued on page 57)*

Dr. Chiang Monlin, who is standing at right, Chairman of the Joint Commission on Rural Reconstruction, observes land contract negotiation, in the house of a Formosa tenant-farmer.



Land office in Taoyuan, Formosa, where transfers of farm land are recorded in carrying out land-to-tiller program.



Land ownership has brought more modern homes to farmers in Formosa. This brick house replaces a ramshackle hut.



# News of the STATE ASSOCIATIONS

## DIGNITARIES ATTEND PENNSYLVANIA SESSION

The 49th Annual Convention of the Pennsylvania Elks Assn. in Harrisburg Aug. 21-24 found its attendance far less than anticipated; the hurricane floods in the northeastern portion of the State limited the number of delegates from that section. However, more than 1,800 Elks and their ladies attended the public opening session at which Mayor Claude Robins and Lt.-Gov. Roy E. Furman extended a civic welcome, to which retiring Pres. Ruel H. Smith responded.

Among the officials of the Order present at this meeting were Grand Exalted Ruler John L. Walker, Grand Secy. Lee A. Donaldson, and Past Grand Exalted Rulers Charles H. Grakelow, George I. Hall and Howard R. Davis.

The fine talk delivered by Elkdom's top executive at the first business session was very well received, as were the remarks made by Pres. Harley Olsen of the North Carolina Elks Assn., another special Convention guest.

The annual Student Aid luncheon was attended by 70 scholars, their parents, sponsors and Grand Lodge and State officials, who participated in the presentation of scholarship checks to 28 young men and women, among them Rose Scarpello of Ambridge who won the third-place \$800 Elks National Foundation Award. Three other students of the Key-

stone State who won Honorable Mention in that competition, received checks of \$500 each. The balance of the scholars were given \$400 checks representing special National Foundation and State Assn. prizes. Another presentation ceremony saw 14-year-old Thomas J. Drungle, a newsboy of Scranton, receive the Carnegie Foundation National Hero Award as the result of his rescuing a drowning companion from an abandoned minehole lake. The young man accepted the award from Scranton P.E.R. Jerome Myers.

Just before the Grand Exalted Ruler and Mrs. Walker left the Convention City for their home on Tuesday, Mr. Walker presented to Past Grand Exalted Ruler Davis a \$1,000 check as a Grand Lodge contribution for Elk relief work in the flood-ravaged areas of the State. This was matched immediately by a \$1,000 Association check, and the next morning, when the full extent of the disaster was made public, the delegates authorized Mr. Davis to wire each of the State's 124 lodges for additional flood relief donations, so that the Elk fund for that purpose could reach the desired \$10,000 very quickly.

The Annual Memorial Service was directed by K. L. Shirk, Jr., P.E.R. of Lancaster Lodge, with Past Pres. Edward D. Smith as memorial speaker and Past Pres. Wilbur Warner eulogizing Daniel J. Miller, the Assn.'s only former leader to pass away during the year.

Reading was selected as the Convention City for the Aug. 19-22, 1956, conclave with Past Pres. H. Earl Pitzer again named as Committee Chairman and Howard R. Davis assigned for the tenth consecutive year the work of the Veterans Service Commission in the State's 12 VA Hospitals. Installed by Grand Secy. Donaldson were Walter Urben, Charleroi, Pres.; A. Lewis Heisey, Middletown, Vice-Pres.; Wm. S. Gould, Scranton, Secy.; George Ellenberger, Jersey Shore, Treas., and Trustee (five years) Clarence E. Thompson, Etna.

The social program featured the President's Ball attended by 500 members and their ladies, with Mr. Davis, Mr. Donaldson, Mr. Urben, Convention Chairman Pitzer and the retiring President as speakers, introduced by Past Pres. Edward D. Smith. The State Elks Chorus competition, voted one of the highlights of the Convention, was won by Butler Lodge with York, Titusville, Williamsport and New Kensington following in that order.

## DANVILLE WELCOMES VIRGINIA DELEGATES

Over 550 delegates and visitors were guests of Danville Elkdom Aug. 27-30 when the 46th Annual Meeting of the Virginia Elks Assn. convened.

Special guests were Grand Exalted Ruler John L. Walker and Past Grand Exalted Ruler Dr. Robert South Barrett, both native Virginians, and Leo P. Ronan of Decorah, Ia., a member of the Grand Lodge Ritualistic Committee.

Mr. Walker's inspirational address, delivered on the 29th, was received with a standing ovation by the delegates, among them 88-year-old Capt. Robert A. Dougherty, a member of Norfolk Lodge who is a resident of the Elks National Home.

Hampton Elkdom was prominent at this conclave—it was chosen as 1956 Convention host. It captured the Ritualistic Title with four of its officers on the All-State Honor Team and one of its P.E.R.'s, Francis J. Howard, was elected as new State Pres. Chosen as Vice-Presidents are Kenneth V. Brugh, Pulaski; Edward L. Curtin, Portsmouth, and Porter R. Graves, Harrisonburg. Reelected were Secy. Charles F. Curtice, Petersburg, and Treas. Donald S. McClarin, Norfolk. V. King Pifer of Hampton retains his duties as Chaplain, while E. V. Foretich, Newport News, will serve as Sgt.-at-Arms, and C. H. Kirsch, Richmond, as Tiler. Retiring Pres. Walter E. Barrick, a member of the host lodge, was appointed as a five-year Trustee, with Lawrence H. Hoover of Harrisonburg to serve as a two-year Trustee.

Business discussions found the Va. Elks Boys' Camp, Inc., a major topic. Having completed a most successful year with 378 deserving boys as guests, the Camp received nearly \$7,000 from the State's lodges which contributed approximately \$60,000 for other charities during the year. The Association voted its third



W. Va. Youth Leader Carolyn Lee, seated left, and Most Valuable Student Award winner Patricia A. Waggoner, with dignitaries in attendance at the West Virginia Elks Convention. Left to right: State Youth Chairman Ross Irle, Grand Exalted Ruler John L. Walker, Past Grand Exalted Ruler Wade H. Kepner, Beckley P.E.R. and Scholarship Committee Chairman W. R. Fugitt, retiring State Pres. L. E. Pruett and Grand Lodge Youth Activities Committee Chairman Dewey E. S. Kuhns.



\$1,000 to the Elks National Foundation and learned from Chairman Morris Lutto that its Veterans Service work had used up \$6,000 in the last 12-month period.

The Grand Exalted Ruler, who was accompanied by his charming wife, presented a \$400 Elks National Foundation Scholarship to Betty Lou Atkinson of Roanoke. A \$200 Assn. Award went to Faith Young of Norfolk, with a \$100 prize won by Grace Barbee of Roanoke. In the Ritualistic Competition, Norfolk's entry was runner-up with three men on the All-State Team, and Suffolk won third-place honors.

Entertainment included tours of the city, a dance each evening climaxed by a Grand Ball, two banquets, a chicken fry and several luncheons.

### 1,500 AT CHARLESTON FOR WEST VIRGINIA MEETING

The three-day Meeting of the West Virginia Elks Assn. which opened Aug. 18th at Charleston was attended by 1,500 Elks and their ladies and honored by the presence of the Order's new leader, John L. Walker. Other Elk luminaries in attendance included Past Grand Exalted Ruler Wade H. Kepner, Chairman Dewey E. S. Kuhns of the Grand Lodge Youth Activities Committee, General Chairman for the Convention, the State's newly-appointed District Deputies and Mayor John T. Copenhaver.

The delegates voted the continuation of the Assn.'s Crippled Children's Camp, a project in which they invested \$3,000, and their monthly entertainment programs at the State's Veterans Administration Hospitals.

Two of the W. Va. students rewarded through various Elk-sponsored competitions who addressed the Convention were Patricia A. Waggoner, a \$500 Elks National Foundation Award winner, and Carolyn Lee Morrison of Beckley, the State's Youth Leader. Sponsored by Parkersburg Lodge, Miss Waggoner's Elk awards for 1955 are over \$1,100.

For the first time in the Assn.'s history a Permanent Secy. was elected at this Meeting—Garnett W. Shipley, a member of Martinsburg Lodge. Other 1955-56 officers of this group are George J. Jones, Wheeling, Pres.; Phil Cramer, Parkersburg; Wm. H. Craze, Morgantown, and W. Don Morris, Huntington, Vice-Presidents, and Frank Lautar, Moundsville, Treas. Retiring Pres. L. E. Pruett of Beckley was appointed a five-year Trustee, serving with E. G. Grisell, Moundsville; Dewey E. S. Kuhns,

Discussing affairs of Elkdom following the banquet which climaxed the Tennessee Elks' Meeting are, seated left to right, Convention Chairman and Ranking Vice-Pres. Henry W. Beaudoin, Past Grand Exalted Ruler John S. McClelland, and Special Deputy S. J. Elkins, Jr. Standing is Grand Lodge Ritualistic Committee Chairman Ed. W. McCabe.



Charleston; P. K. Berwinkle, Weirton, and Nelson Clarke, Martinsburg.

A series of pleasant social activities was enjoyed by Charleston's guests, who returned to their homes with plans to meet at Parkersburg next year.

### CHATTANOOGA TAKES TENNESSEE RITUALISTIC TROPHY

With nine teams participating, the Ritualistic Contest held in connection with the Sept. 1st, 2nd and 3rd Convention of the Tennessee Elks Assn. closed with the officials of Chattanooga Elkdom in first place. The competition was witnessed by many of the approximately 450 persons in attendance at the busy three-day conclave.

Mayor Frank Tohay of Memphis, the host city, welcomed the visitors at the Association banquet during which he presented keys to the city to Past Grand Exalted Ruler John S. McClelland, guest of honor, and to retiring Pres. Maurice Conn and Pres.-Elect E. D. Seagraves of Columbia. At the banquet, the top feature in a series of varied social events, Judge McClelland received a standing ovation at the close of his enlightening address. A dance followed the dinner, during which vocal entertainment was provided by the Confederates, talented second-place winner in the National Barbershop Quartet Contest.

During the business session, the delegates voted to sponsor a "Nurse's Scholarship Contest" in which four scholarships will be made this coming year—one for each of the State's districts. The Association further went on record as being enthusiastically behind the Elks National Foundation Scholarship and Youth Activities Contests and the Veterans Service program, and voted to continue its sponsorship of nearly 100 Boy Scout Troops.

The pattern of this year's Memorial Services was a departure from that of previous years in that it duplicated the ceremony held during the Grand Lodge Convention. The Very Rev. Wm. E. Sanders, S.T.M., delivered a moving memorial address.

Handling the activities for the Assn. with Mr. Seagraves until the meeting at Gatlinburg next year are Ranking Vice-Pres. Henry W. Beaudoin, Memphis; Vice-Presidents Julius Curley, Nashville; George Dykes, Oak Ridge; W. J. Barron, Morristown; Treas., John Menefee, Chattanooga; Secy. James B. Ross, Columbia; Tiler Harvey Plummer, Bristol; Sgt.-at-Arms C. Earl Ogle, Gatlinburg, and Chaplain William Hildebrand, Oak Ridge. Trustees are John Smith, Oak Ridge, three years; Thomas Stratton, Nashville, two years, and John Gasell, Jackson, one year.



Members of Boy Scout Troop 56 were on hand to greet Grand Exalted Ruler John L. Walker, left, and Past Grand Exalted Ruler Dr. Robert South Barrett, second from left, when they arrived at the home of Danville Lodge to attend the 1955 Virginia State Elks Association Convention. Shaking hands with the Order's 1955-56 leader is the Troop's Scoutmaster "Batch" Lemons.

### FORTHCOMING STATE ASSOCIATION MEETINGS

Minnesota	Minneapolis	Nov. 13
No. Carolina	Hickory	Nov. 17-18-19
Virginia	Richmond	Nov. 20
Iowa	Davenport	Nov. 25-26-27
Colorado	Greeley	Nov. 26



# A Time to Remember...

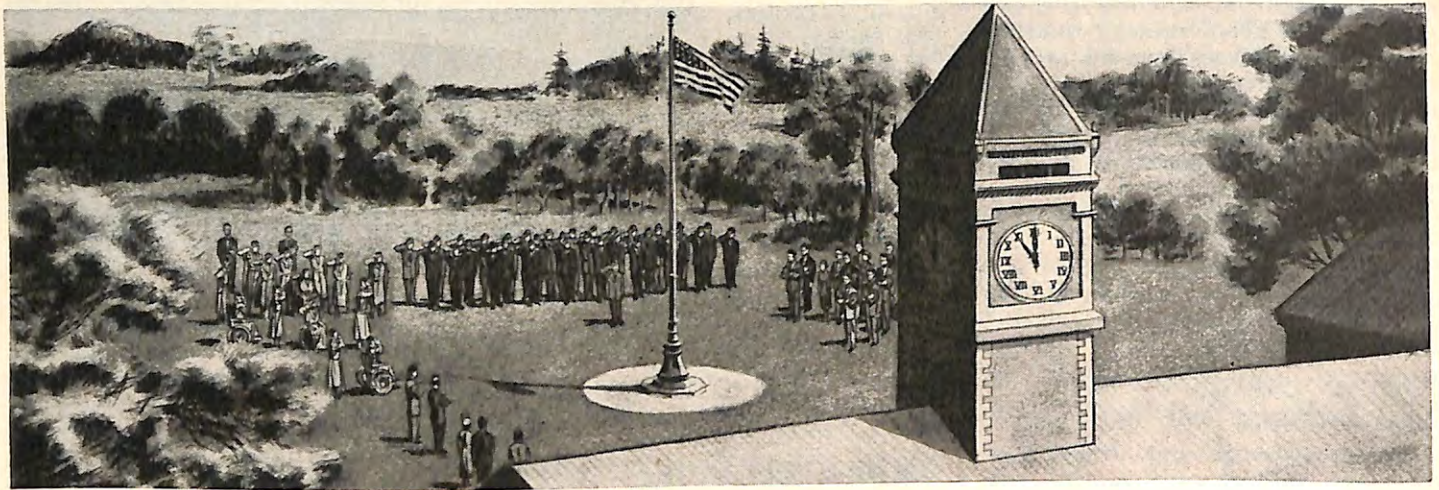

. . . that the Elks have not forgotten

**W**HEN THE FIRST casualties of World War II were announced, the Elks made this solemn pledge: "So Long As There Are Veterans In Our Hospitals, the Benevolent and Protective Order of Elks Will Never Forget Them".

How well has this pledge been kept? On Veterans Day, 1955, we pause to examine the record; proudly we find that in spite of the public's present-day apathy and apparent disinterest in the unheralded tasks being performed behind hospital walls, with a zeal that is inspiring our Committees continue to labor constantly and unselfishly to "serve those who served".

Their work is carried on in all parts of the United States. Their benevolence is ever present in 172 Veterans Administration Hospitals.

## We Serve 127,000

The tremendous scope of the Elks National Service Commission program at the present time is better realized when we consider that on the average day, there will be 106,000 patients in 172 VA Hospitals; domiciliaries account for 17,000 more, and 4,000 are in contract hospitals. About 60,000 of them have various mental troubles; another 16,000 are suffering from tuberculosis, and 6,000 have heart and circulatory ailments; 3,000 will be cancer and tumor patients; arthritis and the like account for another 3,000, and 2,000 will be paraplegics. The balance may be considered those being treated for recurring ailments resulting from war casualties.

It is for these thousands, then, that your programs of encouragement, cheer and comfort range from friendly bedside chats or a hospital errand to professional

variety entertainment, card parties, bingo, boxing, wrestling and other athletic programs. Patients are taken in groups to sports events outside hospital limits.

This type of activity can be described as Companionship Therapy, in which hundreds of our members and their families excel. In the occupational therapy field the Elks have done well, too, particularly in connection with supplying highly valuable and much needed leather to our VA Hospitals, whose budgets cannot provide this expensive luxury. We have won nationwide acclaim for the choice leather hides we have supplied, processed in brilliant colors, a supply whose total value through the years exceeds a quarter of a million dollars. Its chief source has been the California State Elks Association, although many other State Associations, notably Massachusetts, augment this supply through local sources. Radios, television sets and sundry appliances are contributed in an effort to keep minds and fingers busy, easing the boredom of long confinement, and training our veterans for employable skills upon their discharge.

## On the "Medical Team"

Underlying all phases of our program is the effort to give the patients a sense of self-respect—the sense of being "wanted", so that his recovery is hastened and a quick return to his community in a respected and useful capacity is assured. Hence, our Elks and their ladies are recognized as an important part of the "Medical Team" in every one of the hospitals they visit.

Furthering our hospital programs is the newly-launched project aiding the veteran to find employment after hospital

discharge, thus speeding his rehabilitation through his own sense of self-sufficiency and self-reliance.

## Fraternal Centers Continued

Youthful draftees in Service are not forgotten either. Ten Fraternal Centers provide havens of hospitality in Tucson, Ariz., Santa Maria, Calif., Key West, Fla., Columbus and Valdosta, Ga., Waukegan, Ill., Louisville, Ky., Columbia and Sumter, S. C., and Cheyenne, Wyo. Here the lonely service trainee finds a friendly "home away from home" where his uniform is honored as a badge of dignity, and where he can find wholesome recreation during off-duty hours.

Our servicemen stationed in far-off Korea are also remembered; 1,200,000 cigarettes are sent to them each year; their letters of acknowledgment indicate a real and sincere appreciation of all Elks for this "touch of home" in a remote corner of the world.

## Money and Time

Financial aid from the National Commission to assist committees in the performance of their dedicated tasks exceeds \$325,000 annually, a sum more than matched by lodges and State Associations—not only with funds, but, more important, with priceless duty hours at all hospitals, the monetary value of which cannot be computed.

Thus on Veterans Day, 1955, we as Elks rededicate ourselves to our pledge never to forget our country's defenders, happy in the knowledge that whenever and wherever we have been afforded an opportunity to serve those who served, our record has been one of immediate and enthusiastic response.



PAST  
GRAND EXALTED RULER

**Bruce A. Campbell**



ON SEPTEMBER 29th, Past Grand Exalted Ruler Bruce A. Campbell, prominent Illinois attorney and for nearly 50 years one of the great leaders of Elkdom, passed away in a hospital in Phoenix, Arizona. Mr. Campbell moved to Phoenix in 1953 after retiring from his law practice in East St. Louis, Illinois.

Past Grand Exalted Ruler Campbell was born in Albion, Illinois, in 1879, and after graduating from the University of Illinois in 1900, where he attained the coveted Phi Beta Kappa key for his scholarship, he studied law with his father, Judge Joseph M. Campbell, and was admitted to the Illinois Bar in 1901. He practiced law in Albion for a few years and then in 1905 moved to East St. Louis, where he practiced until his retirement. He was a member of the firm of Kramer, Campbell, Costello & Wiechert and a director in several corporations.

Throughout his career as an attorney, Mr. Campbell figured prominently in Illinois politics. He was a member of the Illinois House of Representatives from 1905 to 1907, and a delegate to the Democratic National Convention in 1912 and delegate-at-large in 1924, 1928, 1932, 1936 and 1940. In 1922, 1926, 1930 and 1932, Mr. Campbell was Chairman of the Illinois Democratic State Conventions. In 1932 he was a candidate for Democratic nomination for Governor of Illinois and, although he carried 86 of the 102 counties, he lost in Chicago, where his two opponents resided. Mr. Campbell was President of the East St. Louis Bar Association in 1912, and also a Past President of the Illinois State Bar Association. He was also a member of the American Bar Association and a charter and life member of the American Law Institute.

Bruce A. Campbell was initiated in East St. Louis Lodge, No. 664, in 1905, and immediately took an active interest in the Order. He was Exalted Ruler in 1909-10, and served in an official capacity in the Illinois Elks State Association continuously from 1908. In 1911 he was President of the Association. He had been Chairman of the Illinois Elks Association Crippled Children's Clinic since its organization in 1927.

Mr. Campbell particularly evidenced his interest in Elkdom by his active work at Grand Lodge Conventions, beginning with the Convention in 1910 at Detroit, to which he was a delegate. He attended every Grand Lodge Session since 1910 except one.

In 1914-1917, Mr. Campbell was Chairman of the Grand

Lodge State Associations Committee, and in that capacity gave to the Order one of his most outstanding contributions by preparing a report, correcting the unsettled condition among State Associations with respect to their position with the Grand Lodge, for presentation to the Grand Lodge Convention in 1915. Through these recommendations, in 1916 the Grand Lodge Statutes were amended to establish the present system of State Associations.

At the Atlantic City Convention in 1918 Mr. Campbell was elected Grand Exalted Ruler and, following his year in office, he served continuously on Grand Lodge Commissions that have made some of the most important contributions to the progress of Elkdom. He served on the Elks War Relief Commission from 1918 until the work of that Commission was completed, including one year service, 1920-1921, when the Commission was charged with the duty of investigating the matter of the Elks National Memorial Building and The Elks Magazine. Mr. Campbell was a member of the Elks Memorial Headquarters Commission which constructed the Elks Memorial Building at Chicago and also founded The Elks Magazine. He was a member of the Elks National Memorial and Publication Commission from 1921 to the time of his passing, having served as Vice-Chairman from 1931 to 1937, when he became Chairman.

In 1952 Mr. Campbell received one of the greatest honors of his career when he was awarded an honorary degree by Northwestern University, and also was named one of the 100 outstanding personages in the Lewis and Clark territory in connection with the University's Centennial, which honored these two explorers.

On June 19, 1906, Mr. Campbell married Beulah Wilson Campbell, who survives together with one son, Joseph Bruce Campbell, owner and publisher of the Nashville, Illinois, Journal; one daughter-in-law; one grandson, Bruce A. Campbell II; one great-granddaughter, Cynthia Jean Campbell; one brother, Nigel D. Campbell, and three sisters, Mrs. Robert Craig, Mrs. Harry Ziegler and Mrs. Lloyd Bunting, in addition to several nephews and nieces. Services for Mr. Campbell were held in East St. Louis on October 3rd.

The Elks Magazine, which Mr. Campbell had served so actively and constructively for more than 33 years, joins with the entire Order in extending its deep regret to Mrs. Beulah Campbell, his widow, for the loss of this great Elk.



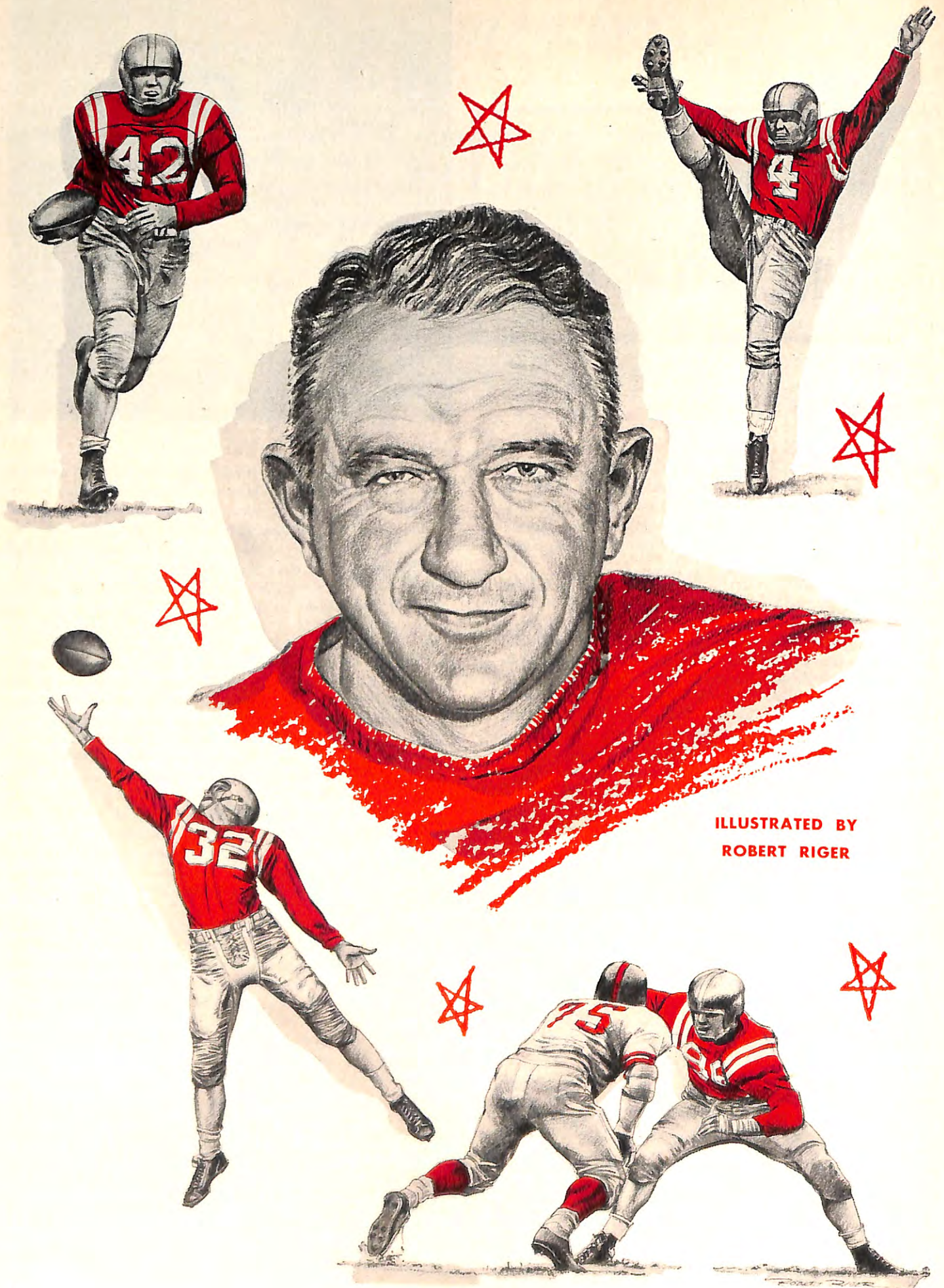

ILLUSTRATED BY  
ROBERT RIGER



# SANDERS of UCLA

**Red Sanders works for the boys who work for him—which explains why his UCLA Bruins are a football power across the nation.**

**BY TOM SILER**

Sportswriter for the Knoxville "News-Sentinel"

**T**WENTY-FIVE YEARS of football coaching—a hazardous way to make a living at best—has done nothing to dampen the wit, nor dull the tongue of Henry R. Sanders, whose UCLA teams are currently riding the high tide of victory on the West Coast.

A few years ago the University of Florida tried to lure Sanders away. Some 2,000 students serenaded the Sanders' apartment, a token of their admiration for the football master with the built-in grin.

"No coach in the world is worth all this excitement," said the coach to his pretty wife, Ann, then added, "I wonder which one has the rope."

A few weeks ago a Los Angeles newspaperman was interviewing Sanders on the common mistakes of the football coach—mistakes in scouting, during the game, and in judgment—and wound up by asking, "What is the greatest mistake a coach can make?"

"To run out of material," quipped Sanders, deadpan and about as serious as he ever gets.

A look at the record would indicate that Sanders—known as "Red" since childhood because of an inordinate fondness for red sweaters—has made few mistakes. Going into the 1955 campaign his six years at UCLA added up to a handsome record of 43 victories, 12 defeats and one tie. The Bruins had lost only three Pacific Coast Conference games in four years. They captured the league championship in 1953 and 1954; and the 1954 powerhouse, undefeated and untied, shared the national championship with Ohio State and won the first annual Grantland Rice Award voted by the Football Writers Association of America. Sanders himself won the highly-prized Scripps-Howard Coach-of-the-Year title.

One major goal looms ahead for Sanders—Rose Bowl victory. His defeat there after a brilliant 1953 season only whetted his appetite for revenge. One lapse turned that memorable battle into

a 28-20 triumph for Michigan State, the Big Ten champion. The Uclans led, 14-0, with four minutes left in the first half. Paul Cameron, the All-American tailback, went back to punt on fourth down from the 10 and already the Bruins had visions of going to halftime with a solid two-touchdown margin. However, Ellis Duckett raced in on Cameron and blocked the punt—he almost grabbed the ball off the kicker's toe—scooped up the ball and ran over for a touchdown. UCLA never recovered from the shock. Red was shaken, too—it was the first blocked punt against him in 11 years as a head coach, six at Vanderbilt, five at UCLA.

It is characteristic of Sanders that he permitted no hangover from that painful experience. The Bruins bounced back last fall stronger than ever, but the team was denied a shot at Ohio State in the Rose Bowl by conference rules—no team can go two years in a row. Now eligible again, the Bruins are generally rated as the team to beat for a return trip to the Pasadena classic, and as a national power again.

**L**AST September an AP poll of sports writers spotlighted UCLA as the team most likely to win the national title again this fall. Asked to comment, Sanders said, "That's the biggest joke I ever heard." He called his squad together and said, "This squad has just been picked in a nationwide poll to win the national championship," whirled around and walked off the field. The tinge of sarcasm in his voice put new zip in the drills.

Red was on solid ground when he disparaged the writers' glowing predictions. He pointed out that the entire first string line of 1954 was gone. The Uclans breezed past the rebuilding Texas Aggies team, 21-0, in the first game of 1955, but missed the seasoned campaigners a week later against Maryland, also a top-flight contender for national honors. Maryland won, 7-0. Even in defeat, however, Sanders' gang indicated it will

be hard to keep out of the Rose Bowl next January.

The pressure builds up in this situation. Yet Sanders doesn't operate like a high pressure guy. Unlike most coaches, Red seldom bothers his staff on Sundays after the weekend games. The battle anew begins on Monday. Three of his assistants—Deke Brackett, Jim Myers and Billy Barnes—use their Sundays to pick up a few bucks scouting National Football League teams playing in Los Angeles or San Francisco.

"Red definitely isn't the finger-nail-biting type of coach," observed Myers, the line coach. "He plans the show and gives up the objective. We don't waste a lot of time on the superfluous."

Brackett recalled that Sanders occasionally would wave everybody off the practice field. "If he thought things weren't going right," Deke said, "or had a hunch about something, he would just call off the whole thing and start over the next day."

Sanders is probably best known as a superb organizer. He delegates the duties to a staff of seven, reserves the barbed-tongue assignments for himself, a chore that does not endear him to the athletes. Last spring one of the better halfback candidates told friends, "I'm going to quit the first time Coach Sanders jumps me." Sanders, of course, heard about the remark.

"Gentlemen," said Red in a squad meeting, "there is a player among you who has said he will quit the first time I get on him. I say to that player that he can quit right now, because I'm going to be watching everything he does from now on."

The player, of course, worked harder than ever. Red is tough, but the athletes respect that toughness. Friend and foe alike marvel at the way the players "put out" for Sanders. However, even Red's staunchest admirers wondered if the celebrated Ronnie Knox wouldn't be too much for him. Three years ago Knox

(Continued on page 48)





for Elks who  
**TRAVEL**

BY HORACE SUTTON

*A small-sized armada is shaping up for the coming cruise season.*

FOR any sufferer from the cold who feels he needs to be evacuated to the lands of palm and balm, a small-sized armada is shaping up in the nation's ports. To Hawaii, the Caribbean, and to South America the ships will transport some 25,000 passengers. According to an estimate made by one major travel agent, American Express, cruisers will spend more than \$20 million on ship fares, shore excursions, and local dust collectors.

The three major ports of departure will be New York, New Orleans, and Los Angeles and San Francisco, although Galveston will tap the rich Texas market. Two ships will buzz around the world—the "Kungsholm" in 97 days touching at such exotic out-of-the-way places as

Funchal, Aden, Bangkok and Bali; and the "Caronia" in 108 days putting in, among other places, at Tristan de Cunha, Durban, Colombo, and, praise be, Long Beach, Cal.

Besides the regular steamship service that ferries vacationers southward no matter the season, there will be at least sixty-eight special cruises, most of them by transatlantic liners which have been diverted from the choppy and frigid North Atlantic run much to the delight, I would suspect, of their crews. Among the famous names that will show up on the atolls of the West Indies will be the majestic "Ile de France" which is booked for three twelve-day cruises, one departing December 22nd for those who want a tropical Christmas and the other two on

January 6 and March 2nd. Later the Ile will make a pair of 17-day excursions and on these trips it will put by at St. Kitts, Fort de France, Barbados, Port of Spain, Puerto Cabello, Curacao, Cristobal and Matanzas. Who could ask for anything more?

That trim little cruiser of the French Line, the "Flandre" takes off out of Galveston on January 17th and from New Orleans on February 7 and 25th. A selection of ports of call for these trips might include San Juan, Fort de France, Port of Spain, La Guaira, Curacao and San Blas. The minimum tariff for this kind of a lark would come to \$470, but there are a number of other sails into the sun that go for less.

While I am on the matter of the ocean liners which have been displaced southward I must make mention of the "Mauretania", that stand-by of the Cunard Line, which begins its season in the sun with a Christmas cruise December 22nd. It will look in on Nassau, Curacao, Kingston, Havana, St. Thomas, Martinique, Trinidad, Cartagena, Cristobal, Port-au-Prince, Antigua and Barbados. If anyone can remember one port from another



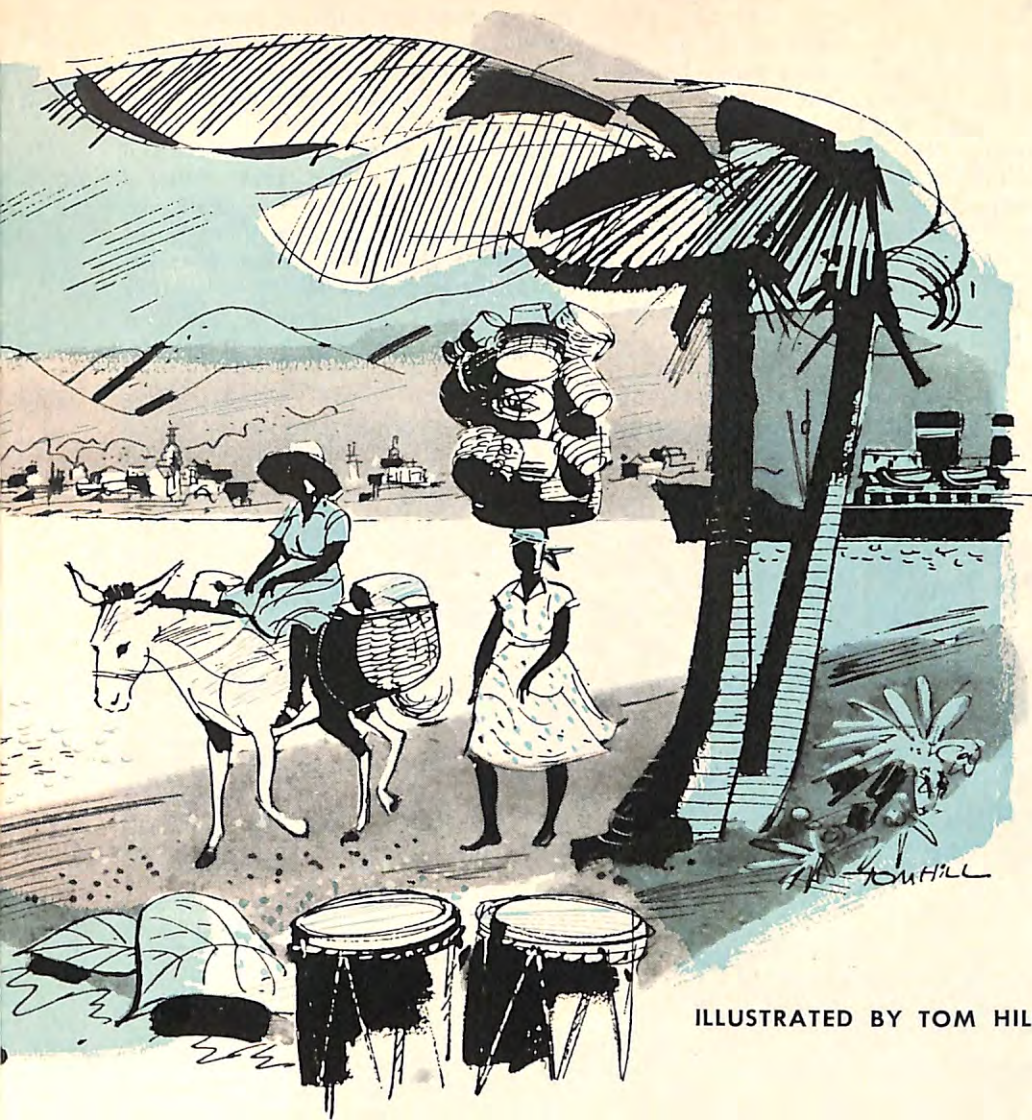

ILLUSTRATED BY TOM HILL

after that rundown it will be a surprise to all hands.

Those past masters of the cruise business, the Dutch, will send the "Nieuw Amsterdam" southward on December 17 on a seventeen-day Christmas trip stopping at the usual ports. Thereafter the big Holland America liner heads for the palms on January 5, February 4 and 24 and March 12. While these trips begin at the edge of the \$500 bracket, those air-conditioned tourist class liners, the "Ryndam" and "Maasdam", can get you a sun tan for less. For instance, the "Maasdam's" January 5th departure out of New York will spend fifteen days, enough for the average man, visiting Port au Prince, Cartagena, San Blas, Cristobal, and Havana at a minimal outlay of \$290.

I mentioned before that a number of southbound trips could be had for reasonable amounts of cash, and in this regard I would like to point out that the Greek liner "Olympia" trots to Nassau and Havana for a week at a minimum of \$175, and so, for that matter, does the "S. S. Nassau" which, despite its name, sails with an Italian crew. The "Nassau"

also goes, perish the coincidence, to Nassau for seven days at \$155. The "Queen of Bermuda" offers five-day cruises to Bermuda, of course, at slightly less, but bear in mind that you will have to debark and find a cabin ashore once the ship puts in to Hamilton.

Out of New Orleans the fanciest rig, I guess, is the famed yacht "Stella Polaris" which is scheduled for excursions of anywhere from 16 to 24 days, all in the  
(Continued on page 43)

### Elks Magazine Travel Service

Travel information is available to Elks Magazine readers. Just write to the Travel Department, Elks Magazine, 50 East 42nd St., N. Y., stating where you want to go and by what mode of travel. Please print name and address. Every effort will be made to provide the information you require, but kindly allow three weeks for us to gather the information. Because of seasonal changes in road conditions, if you are traveling by car be sure to state the date that you plan to start your trip. More and more Elks and their families are taking advantage of this service. Are you?

## FREIGHTER TRIPS YOU CAN TAKE

Ford's Freighter Travel Guidebook shows freighter trips you can take from the U.S. to all parts of the world. Gives detailed information about scores of LOWER COST TRIPS to Europe, So. America, West Indies, the Orient, Hawaii, Africa, Caribbean cruises from \$220. Mediterranean cruises from \$500, around-the-world \$1200, etc. 86 pages, 26 photos showing typical freighter-passenger ships, cabins, lounges, dining rooms, etc. Book tells where ships go, how long voyage takes, fares, addresses of steamship lines, etc. Indispensable to anyone who plans to travel. Mail \$2 today for new Sixth Edition (Winter 1955-56) postpaid.

KENNETH FORD PUBLICATIONS, Dept. E.  
2031 Glendon Ave. Los Angeles 25, Calif.



### VISITING MIAMI BEACH? HAVE FUN AT 1601

Experience real Southern Hospitality at your Elks Lodge in the playground of America. Unsurpassed location overlooking beautiful Biscayne Bay. Attractive bar and recreation rooms. Sandwiches and light snacks served until midnight. Vacationing Elks and their ladies always welcome.

720 West Avenue

Miami Beach, Fla.



### You'll Remember LAS VEGAS

When you stop at Las Vegas, New Mexico B.P.O. Elks No. 408 you'll find true club life and a friendly greeting. More like a home than a hotel. Eight rooms available most of the time—and if price concerns you, forget it—the rates are very reasonable. Hotel rooms restricted to Elks only. Sorry, no facilities for their ladies. Bar and it serves snack meals. When in this locality give our good club a try. We think you'll like it.



### Traveling the Northwest?

Then why not plan to stop off at Centralia, Washington where you'll find 24 well appointed rooms. Rates? Reasonable, of course and guests other than Elks are welcomed. No meals but good eating facilities convenient to our clubhouse. Fine liquor served. Write for reservations as we are usually occupied with resident guests. Enjoy a comfortable club atmosphere among your brother Elks.



# DISTRICT DEPUTY CONFERENCES

AS A MEANS OF acquainting the District Deputies with his "Plan Elkdom's Progress" program for his year in office, Grand Exalted Ruler John L. Walker, following his election at the Convention in Philadelphia, held three meetings. The opening meeting was at the Elks National Home, Bedford, Va., on August 3th; the second at Salt Lake City, Utah, lodge on August 27th, and the final meeting at the Elks National Memorial Building, Chicago, on Sept. 4th. At each Conference the Grand Exalted

Ruler met with his Deputies located near that area and explained his program, designed to encourage every member to "Serve Elkdom—Live Elkdom." in detail. Meeting with the Grand Exalted Ruler and his Deputies were Past Grand Exalted Rulers, the Grand Secretary, and representatives of the Elks National Memorial and Publication Commission, the Elks National Service Commission, the Elks National Foundation, Board of Grand Trustees and the Grand Lodge Committees.

AT ELKS NATIONAL HOME, BEDFORD, VA.



AT SALT LAKE CITY, UTAH, LODGE NO. 85



AT THE ELKS NATIONAL MEMORIAL BUILDING, CHICAGO





# Visiting the Lodges with John L. Walker



Exalted Ruler William R. Kahl of Auburn, N.Y., Lodge, makes a presentation to Mr. Walker during his visit to that city on September 18th. Looking on are left to right, Franklin J. Fitzpatrick, State President and Philip J. Conboy, Vice-President, New York Central District.

ON THE morning of Friday, August 26th, Grand Exalted Ruler John L. Walker arrived in Salt Lake City, Utah. That evening Mr. Walker was entertained at a banquet given by SALT LAKE CITY LODGE, at which all the visiting District Deputies, State Presidents and Grand Lodge representatives were present. The following night the Order's Leader was guest of honor at an informal supper at the Fort Douglas Country Club.

During the fall conference of the Grand Lodge Advisory Committee in Chicago on September 3rd the Grand Exalted Ruler, accompanied by several Past Grand Exalted Rulers, travelled to East Chicago, Indiana, to attend EAST CHICAGO LODGE'S 50th Anniversary celebration. That evening the Grand Exalted Ruler and Mrs. Walker were the honored guests at a Grand Ball. Just before the Ball Mr. Walker made an impressive address to the more than 500 members and their ladies gathered for the occasion. The address was also carried by the local radio station.

On September 7th the Grand Exalted Ruler returned to his home state of Virginia to visit RICHMOND LODGE. After a dinner party at the Jefferson Hotel, there was a meeting held at the lodge. The

meeting was attended by a large number of Brothers from FREDERICKSBURG and PETERSBURG LODGES.

The following morning Mr. Walker paid a visit to HAMPTON LODGE for luncheon. From there, Mr. Walker and his group, accompanied by State President

Francis J. Howard, proceeded to NEWPORT NEWS LODGE, where they were met by Exalted Ruler B. J. Oser and other lodge officers. After the lodge visit, the Grand Exalted Ruler was conducted on a tour of the super-carrier, U.S.S. *Forrestal*, then  
(Continued on page 61)

At the Up-State Conference at Oneida on September 18th, this group picture was taken. Left to right: Past Grand Exalted Rulers James T. Hallinan and George I. Hall, Grand Exalted Ruler Walker, Exalted Ruler Marshall Hope, State President Frank Fitzpatrick and Grand Trustee Hon. Ronald J. Dunn.



With the super-carrier "Forrestal" in the background, this picture was taken when the Grand Exalted Ruler visited Newport News, Va. The hats worn by the party are a safety precaution taken by the Navy. Left to right: Past State Pres. R. M. Ward, Mr. and Mrs. Walker, State President Francis J. Howard and Exalted Ruler Beryl J. Oser.

Grand Exalted Ruler John L. Walker and 27 of the 32 young men and women who received scholarship awards of \$400 each at recent state convention of Pennsylvania Elks, held in Harrisburg late in August.



Members of Richmond, Va., Lodge, with the Grand Exalted Ruler during his visit on September 7th, were left to right: Tom Joyce, Neal Reardon, Exalted Ruler Robert B. Gayle, Francis H. McDuffie, Mr. Walker, William J. Powell, Andrew M. Fleming, Wilbur C. Allen, Past Exalted Ruler A. D. Watson, J. J. Galbraith and Morris Lutto.



This group welcomed the Grand Exalted Ruler to Suffolk, Va., Lodge on September 10th. Left to right: Landon B. Maxey, Sec.; B. M. Scott, Treasurer; Wellons Staylor, Trustee, Mr. Walker; Past Exalted Ruler Robert W. Nelms, Mrs. Walker, Exalted Ruler E. C. Ferguson, Jr. and S. S. Stallings, Trustee.



# News of the Lodges



Officials of Bisbee, Ariz., Lodge present two invalid walkers to the Cochise County Hospital, represented by Miss Marian Christian. With her are, left to right, Est. Lead. Knight L. W. Bodenhamer, P.E.R. and Trustee David L. Ruth and E.R. L. W. Brownell.

## Oklahoma Elks Dedicate Youth Center

The Elks of Oklahoma have seen their dream of a Youth Center become a reality. Work on the project, which will eventually be a \$150,000 installation, began with the signing of a 99-year lease at \$1 a year on a 27½ acre tract near Tishomingo, and officials pushed ahead on plans to have the main hall completed this summer.

A completely fire-proofed edifice with its own water supply and sanitary facilities, kitchen, storage rooms and dining hall, the \$11,000 building was dedicated in August with Past Grand Exalted Ruler Dr. Robert South Barrett, who had donated \$1,000 to this project, as principal speaker. Past Grand Exalted Ruler Earl E. James, a member of the Board of Directors, introduced Dr. Barrett at

this program, during which the Center's President, Herman J. Salz, spoke.

The State's lodges will erect cabins on the site to accommodate potential guests from their own communities who will have the opportunity to enjoy two-week summer sessions and winter week-ends learning all about camp life, various arts and crafts, Bible study, public speaking and general citizenship.

## Athens, Ga., Elks Home is Enlarged

Not long ago, Athens Lodge No. 790 celebrated the completion of a new addition to its home. The event, attended by more than 1,200 Elks and their wives and featuring a barbecue dinner, was highlighted by a dedication address delivered by Past Grand Exalted Ruler John S. McClelland of Atlanta.



Dignitaries who played a large part in the dedication of the Oklahoma Elks' Youth Center at Lake Tishomingo are, left to right, Center Pres. Herman J. Salz, Past Grand Exalted Rulers Dr. Robert South Barrett and Earl E. James and Past State Pres. John M. Collin, Chairman.



E.R. Morgan Wallace hands the keys to a new, fully equipped, \$10,000 Cadillac ambulance, the gift of Wheeling, W. Va., Lodge, to Fire Chief William McFadden. Looking on at left is Past Grand Exalted Ruler Wade H. Kepner; at right is Wheeling's Mayor, Jack R. Adams.



Officers of the newly-organized Robuck Youth Club, sponsored by Abilene, Tex., Lodge, receive the key to their new club room from Roy Nunnally, Manager of the Elks' lodge home. Left to right are Idanel North, parliamentarian; Judy Roberts, Secy.; Donna Lou Majors, Pres.; Mr. Nunnally, and Joanne George, 1st Vice-President.



Tyrone, Pa., Lodge's E.R. James R. Black formally presents the two wheel chairs shown here to Tyrone Hospital to whose building and equipment fund the Elks have given \$42,000 since 1948. Mrs. Alma Schiek accepts the gift as Committeeman Harry R. Gates, left, Ralph Bonsell, second from left, and William C. Barr, look on.





Carol Ann Bates receives a \$500 check from E.R. Charles M. Zellen of Everett, Mass., Lodge, the young lady's sponsor in the Elks National Foundation's "Most Valuable Student" Contest. At right is Est. Lead. Knight Vincent B. English. Second from left is the young lady's father.

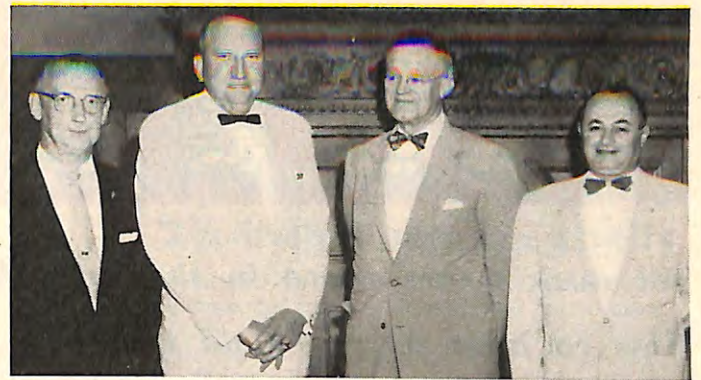

Participating in the dedication of the new addition to the home of Athens, Ga., Elkdom were, left to right: Robert G. Pruitt of the Grand Lodge Committee on Lodge Activities, host E.R. Raymond E. Lester, Past Grand Exalted Ruler John S. McClelland and D.D. Henry M. Rosenthal.



This photograph was taken during Salem, Mass., Lodge's third annual banquet for school-boy golfers, following the tournament the Elks sponsor, and won this year by Joseph Nekoroski. Guest speaker at the dinner was Joseph Batchelder, Past Pres. of the Mass. Golf Assn.



Yonkers, N. Y., Elk officials are pictured with Miss Sabella Marie Minozzi, one of the 12 students sponsored by the lodge this year, when she received her N. Y. State Assn. Scholarship Award at special ceremonies. Pictured third from left is E.R. Carrol J. Gore.



For the third consecutive year, Effingham, Ill., Lodge has agreed to underwrite the expenses of The Rec, a recreation center for the youth of the community, to the extent of \$1,500. Pictured when the Elks presented their check are, left to right, foreground, Youth Activities Committeeman George Wenthe; Rec Boardman Lolomi Keller, E.R. Carl O. Britton, and Pres. Mrs. Robert Buchanan, Secy. Mrs. George Wenthe and Treas. H. K. Dolbow of The Rec Board. In the background are P.E.R. Earl Brown, Secy. N. A. Peterson, Youth Activities Committeemen A. W. Pitchford, Jack Thies, James Dinkheller and Chairman Allen Austin, and Bruce Smith, Vice-Pres. of The Rec Board.



Elks National Bowling Assn. officials photographed during their organization meeting when plans for the 1956 Tournament, to be held at Louisville, Ky., were completed. The 36th annual event will start February 25th and run through April 21st, on weekends only. Further information and entry blanks may be obtained by writing to Assn. Secy. E. N. Quinn, P. O. Box 29, Madison, Wis. Left to right, foreground: J. L. Dries, E. N. Quinn, H. J. Brown, C. J. Steffen, G. A. Schmitt, Urban Herre; second row: Gus Cappel, W. M. Hafner, Assn. Pres. H. M. Lampert, D. R. Wells, J. G. Kraemer, John Connaughton and Past Grand Est. Leading Knight Arnold Westermann.

In the six years during which Athens Elkdom has occupied its present home, its membership has increased from 200 to nearly 900, one reason for the building's expansion. The new addition houses offices for the Secretary and bookkeeper, additional recreational facilities and an enlarged ladies' parlor. One of the most modern in the South, the building is completely air-conditioned and has been entirely redecorated.

### Fulton, N. Y., Elks Give Cruiser to Sea Scouts

A cruiser, acquired recently by Fulton Lodge No. 830 for the Sea Scout unit it sponsors, has been placed at the dis-

posal of Oswego County authorities for use in emergencies on the Oswego River in the Fulton area. The announcement was made by Ralph Wilcox, skipper of the unit, who informed civic officials of the decision to make the boat available for rescue operations in the event of river accidents. He reported that he and the Sea Scouts have prepared grappling hooks and other emergency equipment to assist in such work.

The skipper also stated that an adult person connected with the lodge's Troop Committee would be available on a 24-hour basis for immediate operation of the cruiser in the event that it is needed in an emergency.



Secy.-Treas. L. G. Mehse of the Wyoming Elks Assn., left, presents a \$500 Elks National Foundation Award to Miss Madonna Boley, as Robert H. Morrow, E.R. of Sheridan Lodge which sponsored Miss Boley, looks on.



# ROD & GUN

BY TED TRUEBLOOD

**All duck hunters are in the process of learning how to hunt ducks—none learn all the answers.**



I AM AMAZED again each autumn by the number of men who are not duck hunters hunting ducks. There is a difference. Anybody can hunt ducks; to become a duck hunter requires study and

thought and application—and real enthusiasm.

A friend of mine broke his leg one fall, just before the opening of the season. Naturally, he had to spend some time in the hospital, but as soon as he got out he began attempting to devise a way to hunt.

First, he augmented his conventional equipment with a swivel chair and an apple box. Then he hired two men. They drove him to the pond where he intended to hunt, put out the decoys and set the swivel chair and box in the blind. Then they carried my friend to it, set him in the chair and propped his broken leg, still in its plaster cast, up on the box. He shot this way for several weeks. He was a duck hunter.

The first thing a man must have to be a duck hunter is enthusiasm. Without it, he is licked before he starts. In our country the opening day of the season sees a mass exodus from office, store, shop and farm. Everybody who owns a shotgun is out. Every pothole, pond, slough, creek and river is lined with hopeful nimrods, crouching in the reeds, shouting at their assorted dogs, dashing frantically from one spot to another and blowing loudly on their duck calls.

About ten per cent of the opening-day crowd are real duck hunters who can't wait any longer. The remainder can be divided into three groups: Those who won't go again, those who will go once more, and those who will try it twice more.

We sometimes hunt a spot where the Snake River widens to flow around a group of islands. The road ends on the bank opposite them and the hunters park their cars there and put in their boats.

Last opening day we had finished shooting by the middle of the afternoon and as we were picking up the decoys I noticed a car pull up and park on the river bank beside the others already there. Somebody got out, pattered around

a while and then spread a big piece of white canvas over some brushes at the edge of the water.

When we arrived at the landing we discovered that it was a man hunting ducks. He had on oxfords and nicely pressed slacks. He had put four decoys in the water, close enough to the bank so that he could drag them out with a stick, and he was sitting under the white canvas. Obviously, he hoped that a duck would fly within range. He had a shotgun.

But he was no more than fifty feet from several cars, which no duck within miles could help seeing, and the canvas was about eight feet square. It alone would scare away any duck in its right mind. On top of all that, sitting under the canvas as he was, he would have been unable to shoot if one *had* come by.

THINK some of the opening-day enthusiasts are there because they have seen the happy hunters in the ads. These photogenic nimrods always have big bags of game and they are invariably clean, fresh and immaculately dressed. Tain't so! A successful duck hunter is either hot, sweaty and mosquito bitten or shivering and wet, depending on the season. His clothes are well worn, ragged around the edges and stained from repeated contact with outboard motor grease, mud, blood and grime.

Some of the people who hunt ducks quit when they discover these truths. Others go out on the opening day because

shooting starts at noon and they don't have to get up early. Many, of course, realize that the ducks are innocent then and much easier to bag than they will be a month later. Some like to hunt only when the weather is pleasant.

Anyway, for one reason or another, a lot of the folks who start the duck season with high hopes fizzle out before it has progressed very far. That leaves the field wide open to the real duck hunters and the ducks.

All duck hunters are in the process of learning how to hunt ducks. Naturally, the longer a man has been at it the more he will know, but nobody ever has all the answers and that probably is the sport's greatest attraction.

Last fall our first cold snap started on November 29, and two days later our first big flight of northern ducks arrived. My wife and I were set up on a pothole not far from home, decoys out and ready to shoot, half an hour before sunrise, but we didn't get a duck until 10 a.m. Then they began to move and we shot twelve mallards in the next two hours. The following day we were there early again, and this time we killed our limit between 10:30 and 1:00. So on the third day we got up late and were in our blind with the decoys out at 10 o'clock. The ducks never did fly and, although we stayed until the legal quitting time, we only got two. Why? I wish I knew.

The ducks were there. We could see thousands of them sitting on the open water of a big lake nearby. The weather was exactly the same all three days. We didn't burn out our pothole because we watched hundreds of ducks pour into it after we quit shooting the second after-

Photo by Ducks Unlimited, a non-profit organization devoted to the preservation of wild ducks.



Coming in to feed at a Ducks Unlimited refuge in West Tennessee.



# 20% More knock-down power

## In new Remington "Express" 2<sup>3</sup>/<sub>4</sub>-inch Magnum shells

Your first box will be an eye opener! You'll knock down wary, hard-to-hit game surer, cleaner than ever—because never before have you had such power in a standard-length shell!

You get patterns with more pellets, pellets with more reach and smash—20% more knock-down power in the 12 gauge, proportionately great new power in the 16 and 20 gauge!

No other standard-length shells give you all this power plus "Kleanbore" priming, Flat-Top Crimp and Wetproof construction. Get new Remington "Express" standard-length Magnum loads\* and you'll get your game!

\*To be used only in shotguns with 2<sup>3</sup>/<sub>4</sub>" or longer chambers in good shooting condition.



**Remington** 

"Express," "Kleanbore," "Sportsman" are Reg. U. S. Pat. Off. by Remington Arms Company, Inc., Bridgeport 2, Conn.  
\*Prices subject to change without notice



noon. They just didn't come into it the third day and, not being a duck, I can't even guess at the reason.

In order to be a duck hunter a man has to learn to take disappointment in stride. There will be days when you won't get any, no matter how much you know, how many ducks there are in the country nor how good a setup you have. Some days they won't decoy and a call only seems to frighten them away. Then, though you may rearrange your decoys a half a dozen times and blow your call softly or not at all, they still won't come within range. A man who merely hunts ducks is likely to quit for the season after a couple such experiences, but a real duck hunter can remember similar days in the past. He may not be able to explain what is wrong, but he knows that the ducks likely will pour in like crazy the very next day.

One of the surest indications of a duck hunter—as distinguished from a man who merely hunts ducks—is this: He seldom shoots at a bird that is out of range. A man who merely hunts ducks throws far more lead at fowl he has no chance of killing than he does at those he could.

I went out one day last winter with a couple of young fellows who, no doubt, will become duck hunters eventually because they do have the enthusiasm, but at that time they still had a lot to learn. We had a big stool on the upstream point of an island and there was a brisk up-

stream wind. This meant that every duck that intended to settle among the decoys had to come straight in to the point of the island. Ducks don't light when they are traveling with or across the wind. And our blinds were on the point, directly behind the decoys. This should have insured us the easiest kind of shooting with our first shots at the birds as they came in, wings cupped and landing gear down, and the second as they flared up over the blinds.

**M**OST of the ducks that morning were moving downstream, against the wind, and they came well to the call. We'd open up on them when they still were several hundred yards away and when they saw the decoys they'd set their wings and start to come down. They had too much altitude to drop right in the first time, however, so they'd swing by either to right or left, cross the island, circle back upstream on the other side and then come straight into the decoys to light against the wind.

That is, the few flocks that were allowed to did. Most of them went by the first time at a range of 80 yards or so, and the boys could hold their fire. After they crossed the island and came back with the wind they usually were between 50 and 60 yards away and my companions would have the fidgets so bad by this time that they couldn't resist shooting.

The result was that far more ducks

were missed than hit, and most of those that were brought down were crippled. The river had a brisk current. Every crippled duck meant a long chase with the boat. That was my job.

Naturally, I didn't like it because nine out of ten flocks that circled would have come around again. Then they would have been easy shooting where we could have killed them dead and picked them up from shallow water in which the decoys were set.

I didn't say anything, however. My companions were good boys who didn't lack anything but experience and they couldn't help it if they were unable to hold still in the blind or keep from shooting until the ducks were within sure range. As I said before, they have enthusiasm, and given another fifteen or twenty years they'll be duck hunters.

There are places in this country where it is no longer possible for a man to go duck hunting on his own, setting out his own stool and making his own decisions as to the best location for his blind and the other problems that must be solved. A man shooting in a club or public shooting ground, where the blinds are assigned by lot, takes what he is given and does the best he can under the circumstances. If the wind is wrong there is nothing he can do about it.

Fortunately, however, there still are regions where a man can use his own judg-

(Continued on page 54)





## 100 ANIMALS FOR ONE DOLLAR!

Here's a whole zoo-full of assorted animals to keep the kiddies busy and delighted for days on end. From every continent and in 26 varieties, each is identified on the back and stands erect on individual base. Sculptured in detail and gaily colored, these animals are educational as well as a clever play toy. Set of 100 . . . \$1.00 ppd. Carol Beatty, Dept. 11-W-K, 7410 Santa Monica Blvd., Los Angeles 46, Calif. FREE GIFT CATALOGUE included.

## INDIAN SYMBOL BRACELET

With 5 Indian Charms

Carrying a Message of Friendship

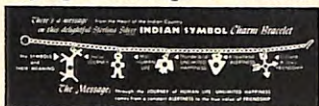

Bracelet Mounted on Card Giving Explanation of Ancient Pictograph Symbols — A Truly Personalized Gift —

In Sterling Silver.....\$2.20 (Tax incl.)  
In Copper.....\$1.00  
Immediate Delivery

Cash Orders Sent Postpaid, C.O.D. Orders Plus Postage  
History of Indian Symbols Free With Each Order

### THE NEW MEXICO TRADER

Box 1471 Albuquerque, New Mexico  
Write For Free Southwestern Gift Folder

## Versatile Olde New England SEWING BUCKET



23" high

23" high; A Lovely End Table!  
A Beautiful Piece of Furniture!

Hand-turned by village craftsmen from hardy native pine. Plenty of storage for scissors, yarn, spindles for thread. When finished, pop your needles into cushion, drop lid, presto! A lovely End Table! Hand rubbed mellow-honey Maple or Salem Antique Brown finishes. Small: 23" by 13", only 10.95 ppd. Large: 24" high (lid down), 15 1/2" diam., only 11.95 ppd. (Please add 50¢ W. Miss. R.)

Money back if not thrilled.

ONLY \$10.95 Postpaid

Puddin' Holler, Box 5E11 East Swanzey New Hampshire

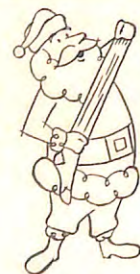

THIS SOCK IS A GENUINE "FIRST". Made from an amazing new Interwoven process that can't wash or wear out — can't be duplicated. Made of 100% Stretch Nylon in the official Elks colors. One size fits all—Ours exclusively in America.

\$1.50—We pay postage.

**Gregony's**

26 NORTH GEORGE STREET  
YORK, PENNSYLVANIA

# Elks FAMILY



**CHRISTMAS TREE NEEDLE CATCHER.** Enjoy the beauty of your tree without the mess of needles on your carpet. This heavy cotton cloth, gaily printed, covers 20 sq. ft. of floor and serves as a colorful background for your gifts. Split up one side, it fits snugly around any size tree or stand. \$1.98 ppd. House of Schiller, Dept. 433, 180 N. Wacker Dr., Chicago 6, Ill.



**LITTLE PRINCESS FUR SET.** Wrap a lass in furs and no matter her age, her heart will be yours for keeps. This set of pure white bunny fur trimmed with genuine ermine tails is styled for 3 to 12 year olds, consists of a snug-fitting hat, scarf and zippered-pocket muff, all lined in gleaming white satin. Set, \$7.95 ppd. Hobi, Dept. E, 15 W. 57 St., New York 19.



**MIST-ER MARTINI VERMOUTH SPRAY.** Here's how to get the ultimate in dryness for your cocktails. This atomizer sprays just the amount of vermouth you want . . . a mere breath or a sweetening shot. Polished nickel plated brass around a cork. Smart looking rayon covered tube and rubber bulb. \$2.95 ppd. Elron, Dept. E, 225 W. Erie St., Chicago 10, Ill.



**NO FOG** will blot your vision when you wipe your windshield with Glassklear, a chemically treated cloth. It prevents fog, mist or frost from forming on windows, mirrors, any glass surface. Use it on show cases, bathroom mirrors, eye glasses. Lasts at least six months. \$1.00 ppd. Viking Sloane Corporation, Dept. C-104, 136 W. 52nd St., New York 19, N.Y.

Merchandise shown on these pages can be ordered direct from the companies listed. Enclose a check or money order.



"TOPS" for the Home, for Athletic Clubs, for Reducing Salons—for MEN and WOMEN!

Enjoy the relaxing, stimulating benefits of efficient vibratory massage! Health Builder gives you pleasant, scientific deep-tissue manipulation — "at the snap of a switch." Helps weight and figure problems, muscle-toning, blood circulation. Widely used in Health Institutions. Built for years of service—fully guaranteed. WRITE today for literature and new booklet, "BE GOOD TO YOURSELF!"

**Battle Creek**  
EQUIPMENT CO.

BATTLE CREEK 10, MICH.

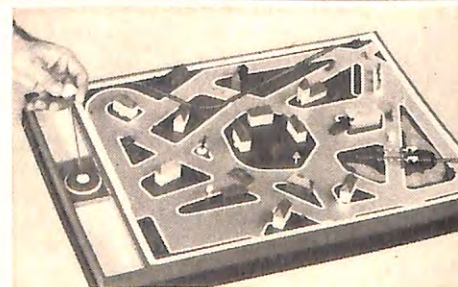

## Imported Magnetic Game

It's new! It's unique! It's just like a miniature Driving School! You simply move the "joy-stick." It operates a hidden magnet. And like magic the cars, trucks and motorcycles drive, by your direction, through a miniature town. Railroad crossings gates raise . . . garage doors open and close . . . all automatically for the vehicles. It's a completely different Christmas gift for the kids . . . you men will enjoy it too! Order today! Only \$6.95 ppd. Douglas Homs Co., 165 O'Farrell St., San Francisco.



# SHOPPER



**DO YOU SECRETLY THINK** the little woman deserves a medal for putting up with you? Get her one, specially struck for "Distinguished Marital Service." In sterling silver or gold filled. Three sizes: 1" diam. \$4; 1 1/4", \$5; 1 1/2", \$7 ppd. inc. tax. Give full name and number of years married. Wayne Silversmiths, Dept. E, 546 So. Bway., Yonkers 5, N.Y.



**WHEN MOTHER WAS A GIRL**, she may have spooned by the light of just such a Lamp of Opal Hobnail Milk Glass. This modern pin-up version adds a charming touch from the past to any room. With decorative turnkey and white eyelet shade. 8 1/2" diameter extends 10" from wall. \$7.95 plus 25c handling. Laurel Gifts, Dept. E, Box 312, Flushing 52, N. Y.



**ROYAL STAFFORDSHIRE BONE DISHES** in the famous 18th Century "Tonquin" pattern. These English imports were originally used for fish bones but modern decorators have adopted them as graceful ash trays and candy servers. 6 1/2" x 3 1/2", assorted colors. 3 for \$3.50; 6 for \$5.95 ppd. Here's How, Dept. E, 27 E. 22nd St., New York 10, N.Y.

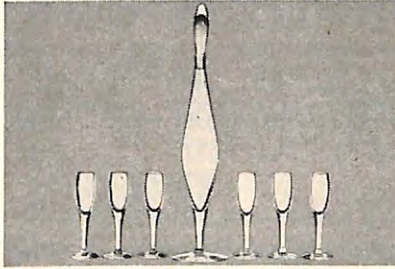

**CRYSTAL CORDIAL SET** with one of the most graceful decanters we've seen. The seven sparkling pieces are hand blown and hand finished crystal. And the price is right so you'll probably want a set for yourself as well as to give some lucky friend. Decanter, 11" high, glasses, 4 1/2". \$5.95 ppd. Taylor Gifts, Dept. E, Spread Eagle Inn, Wayne, Pa.

**Except for personalized items, there is guaranteed refund on all merchandise returned in good condition within 7 days.**

## IMPRESSIVE GIFT for an Elk



12"x15" Walnut and Metal Plaque for home or office. Every detail of this splendid plaque reveals the donor's good taste and recognition of quality. Solid walnut, 3/4" thick, carefully selected for the most attractive grain markings, has been hand rubbed to a satiny smoothness, and lacquered to a semi-gloss. The edges are beveled.

The Elk's head is solid metal, cast from a vividly life-like sculpture of a trophy head. Emblem, head and name plate, all of heavy metal alloy, are finished in a lustrous Jeweler's Bronze.

Price includes a three line inscription engraved on the name plate: for example, member's name, lodge number and city; or, perhaps a commemorative message.

Truly a superb show piece, it's a gift you will be proud to present. \$19.50 ppd. Please send check or money order. No C.O.D.'s, please, but if you are not sincerely pleased, return the plaque within 7 days and your money will be refunded without question. **\$19.50 ppd.**

EMBLEM DISTRIBUTOR CO., 1153 Lincoln Ave., San Jose, Calif.

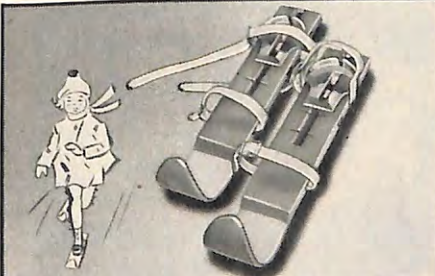

## Thrilling Snow Skates

The wonderful fun of skating and skiing combined in perfectly safe miniature skis! Steam-bent hardwood with sturdy fitted heel plates. Adjustable straps fit ages 4 to 11. Skates are 12 1/2" long by 2 1/4" wide. Order No. T-4237. Snow Skates, \$1.79 pair, postpaid.

WRITE FOR FREE GIFT CATALOG!



Miles Kimball

346 Bond St., Oshkosh, Wisconsin



Personalized NAME PLATES

Pat. Pend.

## FOR THE JUNIOR SET

**\$1.00**

Personalized license plate carries name or nickname of pint-size pedalers in their own state colors. 8" x 3 1/8" heavy steel tag in baked enamel colors (up to 7 spaces—no numerals or abbrev. marks). Insures wagons, scooters and bikes from getting lost. \$1.00 postpaid. (No C.O.D.'s) B. Cantor, Dept. EM-11, 1831 Chestnut St., Phila. 3, Pa.

Plus 10c. if 1st Class Mail desired.

ORDER CHRISTMAS GIFTS NOW!

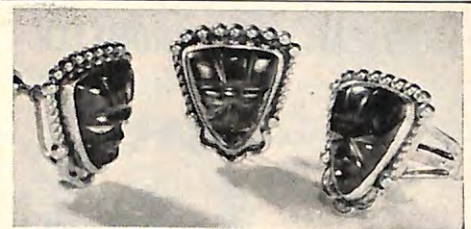

## BLACK BEAUTIES

Ring..\$3.95 Earrings..\$3.95 Complete Set..\$7.50

High style jewelry co-ordinates carved with Inca Indian good-omen symbol. Handsome black onyx set in Sterling Silver or 14 kt. Gold plate. Dramatic in appearance, will net dozens of compliments.

Send ring size or measure with string. Satisf. guar. Matching Cuff-Links..\$3.95 Matching Tie-Clasp..\$3.95 Send cash, check or m.o. For COD's send \$2 deposit

OLD PUEBLO TRADERS Box 4035, Dept. ELO Tucson, Arizona

## BRAND NEW GAME SWEEPING THE COUNTRY



Appeals to anyone, young or old. No dull moments. All the scoring of real bowling plus the excitement of a dice game. Set includes plastic dice box, two engraved dice, bowling score sheets & instructions. Only \$2.00 pp.

WRITE FOR FREE CATALOG.

LUDERUS BROS. Dept. 5, 4734 No. 34th St., Milwaukee 16, Wis.

## MAN-SIZED PILL BOX



Actual size shown—5.00

A gift of Old World distinction for this Vitamin (and Aspirin) Age! Our convenient side-slot pill box, designed with authentic coins in an antique silver or old-gold finish.

Mail & telephone orders invited.

FLEETWOOD LTD. Dept. 11, 866 Sixth Avenue, New York 1, N. Y.



# YOU NEED THIS!

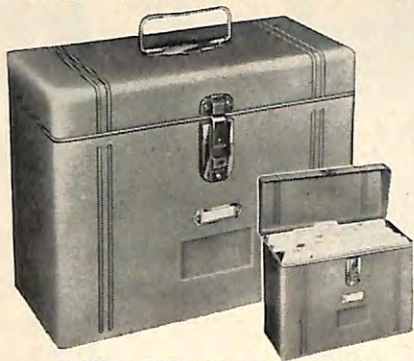

**FRANKLIN PERSONAL BUSINESS FILE**  
A new useful portable filing box to keep records, safeguards household papers, correspondence, insurance, receipts, taxes, etc. A traveling office.  
Sturdy steel construction, 12" x 10" x 3 1/2". Complete alphabetical index and auto. light, heat, phone, taxes, insurance files, Nickel plated key-lock and handle. Permanent Baked Enamel—Colors: Hammerloid Gray-Green-Walnut.  
Finest Quality Portable Filing Case Made. A Pleasure to Own—A Thoughtful Personal Gift. Satisfaction Guaranteed.  
Only \$4.25 postpaid or 2 for \$8.00 postpaid  
Send Check or Money Order to:  
**FRANKLIN FILE BOX MFG. CO., INC.**  
Dept. M, 16 W. Kinzie St., Chicago 10, Ill.

## IMPORTED WALL BAROMETER

From Western Germany. Jewel-like movement is visible through open faced dial. Polished anaroid precision movement and dial set in bevelled mahogany case. Polished brass stem and ring for easy handling. 5" dia. Postpaid



**\$5.95**

FREE! New Gift Catalog  
**TAYLOR GIFTS** (Dept B 11) Wayne, Pa.



★  
**POP MUSIC FANS!**  
★

... love this new rack for 45 rpm records! Holds 225 singles or 140 extended-play albums. Shelf holds record player or radio. Sockets will stack more racks as collection grows! (Comes assembled, 22" x 14" x 9" with rubber tips. Holds books and record tapes, too! \$6.95 in black iron or \$8.95 brass-plated, ppd. Please remit with **\$6.95** order. **MONEY BACK GUARANTEE!** Not sold in stores. Ask about our long-play record rack, too!  
© LESLIE CREATIONS • Box 9516 • Dept. 213A • Phila. 49, Pa.



## Personalized Lunch Pouch...

soft and pliable and can be folded for carrying home in pocket or purse. Generous size 10"x5 1/2"x4 1/2". Colorful plaid Vinyl cushioned with miracle fibre glass insulation that keeps contents hot or cold for hours. Heavy duty zipper on 3 sides so that lid opens fully for easy access. Personalized with any first name (as shown). Complete with name of your choice... only \$1.49 ppd. Carol Beatty, Dept. S11-W, 7410 Santa Monica Boulevard, Los Angeles, 46, California. **FREE GIFT CATALOGUE** included.



## You Too Can Give Mink This Christmas

Everybody loves mink... and these genuine Mink Cuff Links and Rhinestone Jeweled Mink Paw Key Chains, designed by Vison-Patte are sure to thrill your very special friends who have "everything." Both Key Chain and Cuff Links are available in Natural Dark Brown, Grey, White, Pastel and Silver Blue. Gift Boxed. Only \$3.95 for the Cuff Links or Key Chain, \$7.50 for the Set, Money Back Guarantee. Check or Money Order we pay postage. Calif. residents add 4% tax.

**INCE-SIEGEL CORP.**

706 S. Hill St. Los Angeles 14, Calif.



## ORIGINAL CHRISTMAS DECORATIONS

**JEWELLED FAN AND FIGURINE.** Heavenly blue 7" kraft fan with sequined gold border creates a dramatic background for delicate ceramic madonna whose blue mantle is also bordered with colorful sequins. Both for \$2.95 ppd. **JEWELLED CANDLE HOLDER.** Sparkling sequins give a festive air to 4" candle holder with slow burning vigil candle. Ideal for table lighter or mantel groupings. \$2.00 ppd. with candle.

Dept. E-11  
727 Sheridan Road  
Evanston, Illinois

## The SEA HORSE

**Personal PHOTO Christmas Cards**

including envelopes

**25 \$1**  
FOR  
PLUS 35¢  
SHIPPING

from your own negative

**LIMITED TRIAL OFFER — 1 order per customer.**

**FREE SAMPLE.** Just send snapshot negative (of child, family, home, pet, etc.) for free sample, rich, handsome, embossed DeLuxe Yulecard, from world's largest producer. Please include 6¢ stamps for handling (after Dec. 1, 10¢). Negative returned with sample and illustrated style and price folder. (If without negative, send photo and 50¢ for new negative.) See before you buy. No obligation. Satisfaction guaranteed. Write today.  
\*T.M. Reg.

**YULECARDS\*** Dept. 67, Quincy 69, Mass.



**MEN—and Women, too!**

**EXEROW**

for your  
**HEALTH**  
and  
**FIGURE**

Send for  
**FREE BOOKLET**

**RIDE and ROW THE BATTLE CREEK WAY!**

Enjoy most efficient health-building rowing AND riding! Natural HYDRAULIC pull of rowing plus benefits of horseback riding—adjusts for mild exercise or strenuous workout as you wish. Rhythmic movement of handles, seat and pedals "symmetrizes" and beautifies entire figure. EXEROW safely normalizes **WEIGHT**—improves **HEALTH** and appearance. Write **TODAY** for literature and booklet.

**Battle Creek** EQUIPMENT CO.  
Battle Creek 12, Mich.

# ELKS FAMILY SHOPPER



**DOLL HOUSE BRIDGE SET.** All five pieces fold just like the big ones and you'll probably have so much fun with it, you won't want to give it away. Table is 3" square and chairs are in proportion. Sturdy metal, painted black, hand decorated with roses. \$2.95 ppd. Artisan Galleries, Dept. E, 2100 No. Haskell Ave., Dallas 4, Tex.

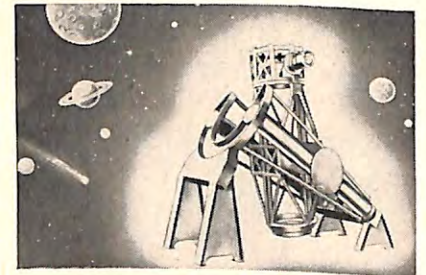

**MT. PALOMAR TELESCOPE** in kit form. Scaled and designed from the blue prints of the Hale 200" instrument, this working plastic model reveals the moon's craters, the stars and planets to backyard astronomers. Complete precision optical system. Assembled in 30 minutes; 17" high, 21" long. Comes with Star-Gazer's Manual. \$9.95 ppd. Sunset House, 75 Sunset Bldg., Hollywood 46, Calif.

## Cigarette Bar

What—out of cigarettes?

You won't be if you own this decorative antique pine dispenser. Holds full carton—Regular or King size. Makes a very unique gift!

Everyone gets a "kick" out of the verse:

"Tobacco is a dirty weed: I like it. It satisfies no normal need: I like it. It makes you thin, it makes you lean. It takes the hair right off your bean: It's the worst darn stuff I've ever seen: I like it."

\$1.89 postpaid

**Gifts! MASTERCRAFT** 212K SUMMER BOSTON 10, MASS.  
**FREE! GIFT 'N GADGET CATALOG**

**LOOK! Electric Greyhound Bus**  
**NEW 1955** \$198



Post-paid  
Goes  
Backward  
and  
Forward

Here is the sensationally new 1955 scale-model Electric Greyhound Bus that captivates every child (and mommy and daddy, too). One flick of the magic gear lever and off it goes—forward or reverse. Runs for hours. Driven by an electric motor, powered by flashlight battery—safe, economical—easily replaced. Comes completely assembled with headlights, balloon-type rubber tires—durable metal body. Buy now for Xmas. **SEND NO MONEY** Rush your order today. Remit with your order and we pay postage and handling or order C.O.D. plus postage and handling.  
Dept. EL12, P.O. Box 209, Cambridge Station, N. Y. 25, N. Y.



# ELKS FAMILY SHOPPER



**MOUTON FUR COLLAR** for the sub-teen set is just like the fur collars so popular with their older sisters. It dresses up a coat, sweater or dress and makes last year's outfit seem new. Adjustable to fit little girls from 6 to 12 years. In brown, pink or white. \$1.95 ppd. Huss Bros., Dept. FE, 100 W. Chicago Ave., Chicago 10, Ill.

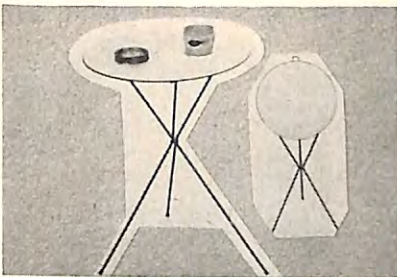

**TILT-TOP TABLES** keep you serene even when entertaining a crowd and come in right handy for the family TV snacks. Lightweight, folded for storage with one motion, they have baked masonite tops in turquoise, maize or tangerine, 15½" in diameter. Wrought iron legs. Two for \$5.00; four for \$9.50; exp. chgs. coll. Lee-craft, Dept. ELS, 300 Albany Ave., Brooklyn 13, N. Y.



## GARMENT BAGS

For • HOME  
• TRAVEL • GIFTS

Superior quality, heavy gauge (SEE THRU) long-life plastic bags with full length zippers to protect your fine clothes from MOTHS, DUST, DIRT, WRINKLES. These are long lasting bags of the finest workmanship. Order one for every suit or dress in your wardrobe. **WONDERFUL GIFTS.**

SUIT 2 for \$1.89 } One Suit  
2 for \$3.50 } One Dress  
DRESS 2 for \$2.25 } 2 for \$4.25 } \$3.89  
SEND FOR CATALOG

RHT MERCHANDISE CO.  
BOX 1278, STUDIO CITY  
CALIFORNIA



## 100 PERSONALIZED POSTALS \$1

Your own name and address neatly printed on 100 fine quality white vellum post cards. Used for correspondence and as regular post cards . . . always neat and efficient looking. You'll want a supply for home use . . . and you won't find a nicer gift for business friends and students. And \$1 per 100 is the lowest price ever. (Special 200 for \$1.75!) Handy Gifts, 1106 Jasperson Bldg., Culver City 6, Calif.

**SAVE ON XMAS GIFTS**      **BUY DIRECT FROM IMPORTER**

COMPLETE CAMP KIT

**Special 12 Pc. SPORTSMAN'S KNIFE**

OVER 10,000 SATISFIED CUSTOMERS ORDER TODAY

Complete with Genuine Leather Holster!

**IDEAL GIFT FOR FATHER, SON OR FRIEND . . .**

**Eliminates 12 Individual Items from Pack or Tool Kit**

Here is the Perfect, Combination Knife-Tool for every Outdoor Sportsman, Hunter, Camper, Fisherman, Boy Scout, Ranger, Rancher, etc. Think of it! 11, Fine quality Steel Tools, precision made to fold easily into the heavy bone covered body. In one neat, compact unit you have (1) a regular knife, (2) a fork, (3) a spoon, (4) a draw knife, (5) a bone-saw and fish-scaler, (6) scissors, (7) a can and bottle opener, (8) a cork-screw, (9) awl punch, (10) a screwdriver and (11) a metal file. All this PLUS a genuine leather, belt holster

**4.95 WITH CASE**

---

**3400 RPM — ½ HP POWER SAW**

COMPARES TO SAWS SELLING UP TO \$49.50

**1978 WITH A 5½" BLADE**

**RIPS - CROSSCUTS CUTS FINISHED 2x4 LIKE KNIFE THROUGH BUTTER**

A rugged, professional type, adjustable saw. Will cut any angle from 0 to 45°. Has an adjustable (0 to 6") rip fence. Safety-trigger switch on handle. Full ½ HP Universal AC-DC, 110-120 Volt, 60 cycle motor. Weighs only 6½ lbs. Thousands already sold. Your satisfaction guaranteed.

EXTRA SAW BLADES — Available in Rip, Crosscut or Combination. Please Specify . . . price per each **275 EA.**

**SATISFACTION GUARANTEED OR MONEY BACK**

ORDER TODAY for Xmas Delivery — Pay by Money Order or Check. ½ deposit with C.O.D.'s. All prices F.O.B. Los Angeles.

**Palley's**      2263 E. VERNON AVE., DEPT. E-11. LOS ANGELES 58, CALIF.

## Make Your LAMPS into CHRISTMAS TREES



cleverest decorating idea in years!

Now you can bring Hollywood's famous "Christmas Tree Lane" right into your home. These perfect replicas fit over any lamp in place of your regular shade. Make all your lamps into Christmas trees. Beautifully lithographed in forest green with white "snow" on branches that stand out for easy decorating. Can be used for many years. Complete with simple illustrated instructions. At this low price you'll want several. Order now . . . Sorry, No C.O.D.'s. 17 inches high 17 inches diameter

CHRISTMAS TREE LAMP SHADES Dept. 34 P.O. BOX 98, MURRAY HILL STA., N. Y. 16, N. Y.

Please send me \_\_\_\_\_ Christmas Tree Lampshades for which I enclose \$\_\_\_\_\_

Check  Cash  Money Order

Name \_\_\_\_\_

Address \_\_\_\_\_

City \_\_\_\_\_ Zone \_\_\_\_\_ State \_\_\_\_\_

**FREE** With each order of 2 or more shades you'll receive FREE a 12-page book of the world's most popular Hymns and Carols . . . words and music.

# 49½¢ STORM WINDOW

protects your family . . . all winter . . .

No Nails  
No Hooks  
No Screws  
No Tools



**JUST PRESS ON — That's all!**

Now . . . Storm Windows need not cost up to \$14.00. The world famous REYNOLDS ALUMINUM people have developed this light weight flexible product that seals out wintry blasts for as low as 49½ cents a window! Imagine—for pennies you can insulate 'most ANY room in your home! This storm window is as transparent as glass yet can't peel, chip, shatter or rattle! Weighs less than ¼ of the lightest glass windows developed—yet it has the tensile strength of over a TON per square inch! Crystal-clear, yet flexible like rubber! Not affected by snow, sleet, rain or dampness—because it's 100% waterproof. Won't crack at even 53 degrees BELOW FREEZING. Use and re-use YEAR AFTER YEAR for winter comfort and protection.



Lift Border for Airing

## INSTALL IN 5 MINUTES

No nails, hooks, screws or tools. Just cut to fit window (any shape) then press on special Adheso border. That's all! No hard work no broken glass. Simple! Easy—a child can do it. Cleans easily with damp cloth, too! At winter's end, fold away like cloth for next year.

Over 2,000,000 Sold

No wonder so many home owners, hospitals, churches use this tried and true REYNOLDS METALS product—over 2,000,000 sold last year! A 36" x 43 1/2" TRANS-KLEER kit—108 sq. feet, enough for 10 windows of 10.8 sq. feet—complete with Adheso Border is \$4.95, just 49½¢ a window! 10 glass windows would cost \$79 to \$160—you save a terrific sum on purchase and on fuel savings! Play safe—order NOW on trial. REYNOLDS METALS can produce only so much—no more. Act fast, mail coupon now. Enjoy new comfort, feel the difference—even test with thermometer. Then, if not convinced, your \$4.95 comes back! Only 2,500,000 can be made this year—and demand is going up! Avoid disappointment! RUSH COUPON TODAY!

THORESEN'S, Dept. 103-M-47  
352 Fourth Avenue, New York 10, N. Y.

RUSH . . . Kits Trans-Kleer measuring 108 sq. ft. (10 windows averaging 10.8 sq. ft. each), with Adheso Border on 7 day trial—money back guarantee.

Payment Enclosed. Send Prepaid.  
 Send C.O.D. plus postage.

### CHECK AMOUNT DESIRED

1 KIT (108 sq. ft.) for 10 windows — 4.95  
 2 KITS (216 sq. ft.) for 20 windows — 8.95

Name \_\_\_\_\_

Address \_\_\_\_\_

City \_\_\_\_\_ State \_\_\_\_\_



# SURPLUS TOOL BARGAINS

SAVE UP TO 50%

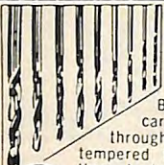

## 41 SURPLUS TWIST DRILLS

For hand or electric drills. Brand new genuine hardened carbon tool steel drills from 1/16" through 1/4". Each drill designed and tempered to give up to 1800 drillings through steel, aluminum, iron, wood, plastic. Sells in the stores for up to \$6. Set of 41 drills \$2.00.

\$2

## 5 PLIER SET

For jewelers, optical workers, hobbyists. These superb German instruments are of drop-forged, high-quality tool steel. All ground and smooth working joints with just right tension, jaws meet perfectly to safely and securely hold most delicate objects. Each plier is 4" long and a veritable gem of precision and strength.

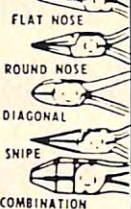

All 5 for \$3.50

75¢ EACH

Take The Work Out Of Using Screws With The Sensational

## Supreme POWER DRILL SCREWDRIVER ATTACHMENT

Fits all Drills 1/4" and Larger

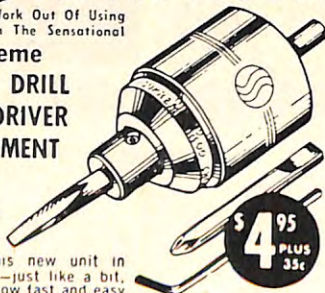

\$4.95 PLUS 35¢

Clamp this new unit in your drill—just like a bit, and see how fast and easy it runs every screw up tight! Light, compact and fool-proof, this attachment is actually a screwdriver blade with a built-in clutch. The spinning drill chuck drives the screw only when you press with drill. Release your pressure, and the friction clutch releases the screw and Phillips blades included for either slotted head or Phillips screw, with Allen wrench and complete instructions. For screws up to 3/16" (three sixteenths) diameter... only \$4.95. Also Heavier Duty model for screws to 1/4" diameter—only \$6.95.

### ORDER ON 10-DAY TRIAL GUARANTEE

All surplus and direct imports. Sold on money back guarantee. Send check or money order with name and address. We pay postage. If C.O.D. you pay postage and C.O.D. charges. Money back guarantee protects you fully.

**SCOTT-MITCHELL HOUSE, Inc.**

Dept. 5111, 611 Broadway, N. Y. 12

## A Lifetime Gift for FLOWER LOVERS



### All-Steel Vio Holda PLANT STAND

Sturdy, heavy gauge all-steel welded. 40" high. Will not tilt or tip. Holds 11 plants, 10 on revolving arms extending outward 6" to 12" from center shaft. Arms moveable to any position to enhance beauty of display and allow even sun and air exposure. Light weight. Easily dismantled for cleaning. Antique black; white or green enamel.

ORDER BY MAIL TODAY Only \$14.95 each, plus \$1.00 for packing and postage in U.S.A.; \$2.00 for shipments to Canada.

Specify color desired. Send check or money order; or C.O.D. immediate shipment. Satisfaction guaranteed. Circular on request.

NO TIP NO TILT

**VIO HOLDA Manufacturing Co. Inc.**

Box 915 Dept. 23-N Topeka, Kan.

Write for Catalog

*James 7-12-89*

### Family Heirloom

Birthday lists of junior charmers, become a source of pride as they continue to grow.

Heavy sterling silver chain bracelet.....	\$3.00
Available in 12 kt. gold filled.....	\$4.00
Sterling silver disc 7/8" dia. with first name and birth date engraved in script..... each	\$2.50
Available in 12 kt. gold filled..... each	\$3.00

All prices include engraving, Federal tax and postage

**Wayne Silversmiths** 546 SO. BROADWAY YONKERS 5, N. Y.

### Personalized Gifts of Sterling

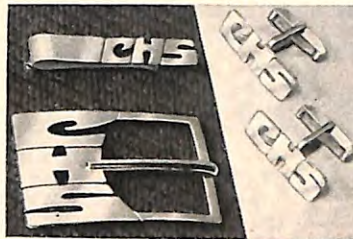

**FOR THE MEN IN YOUR LIFE**—our handsome, handmade sterling silver belt buckle, tie clip and cuff links... the gifts a man will wear with pride—keep forever. Specify 2 or 3 initials desired. Orders shipped within week. Buckle—\$8.80; Tie Clip—\$3.85; Links—\$7.95. Set of 3—\$18.95. Prices inc. tax and postage. No C.O.D.'s please.

**Robin Hood's Barn, Inc.**

Dept. K115 680 High St., Westwood, Mass.

## Save \$100<sup>00</sup> a Year and Never Be "Broke!"



Get Perpetual Date & Amount Banks. 25c a day automatically keeps Date right up-to-date. Forces you to save a quarter every day, or date won't change. Also registers total amount in bank. Foolproof mechanism with

key. Use year after year. Start saving right away. Order several. Now only \$1.99 each; 3 for \$5.75; 6 for \$11.00 postpaid. Send cash, check or money order to LEECRAFT, Dept. EL, 300 Albany Ave., Brooklyn 13, N. Y.



### GENUINE WILD GRAY FOX SKIN

Your little "frontiersman" will be the envy of his neighborhood when he has one of these real, honest-to-goodness gray fox skins hanging on his wall or as a rug beside his bed. Trapped in the wilds where Davy Crockett once roamed, the pelt has been tanned to keep it soft and luxuriant. Skin is 36" overall... fur is thick and has its original color tones. Comes with fascinating wild life lore about foxes. An unusual and wonderful gift for Christmas or birthdays. Only \$2.95 postpaid. Also available... real gray wolf skin, 4 1/2 ft. overall \$5.95. ARTISAN GALLERIES, 2100-Q11 N. Haskell, Dallas 4, Texas.

# ELKS FAMILY SHOPPER

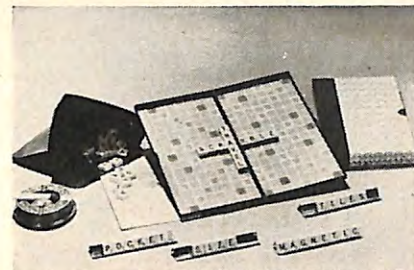

**TRAVEL SCRABBLE** with magnetized tiles. No more scrambled scrabble with this clever game. The tiles won't slide on the metal board so you can play in comfort even in a car, plane, ship, etc. Set folds for carrying to a compact 8" x 4" x 1". With instructions, racks, gift slipcase. \$7.95 ppd. Holiday House, Dept. E, Bellevue Theatre Bldg., Upper Montclair, N. J.



**COOKIE BUCKET.** You can almost smell grandma's fragrant kitchen when you see this old style bucket of native pine, finished in a mellow Salem maple. Use it for cookies or trail green leaves over its side and turn it into a charming colonial decorative touch. 8" high, 9" across, red lettering. \$2.95 ppd. (add 35c W. of Miss.) Puddin' Holler, Dept. E, East Swanzy, N. H.

Gift Boxed

For Dad or Lad

### MONEY BELT

Concealed zippered pockets provide safe hiding place for cash. Top quality leather. Men's brown or black cowhide, 28-44.....\$3.95 Boys' brown horsehide, 28-36.....\$1.95

**CLARION PRODUCTS**  
BOX 488K HIGHLAND PARK, ILL.

NOW write in SILVER & GOLD

Imagine! For the first time you can write in real silver or gold! Personalize Christmas cards! Initial luggage! Protect cherished belongings. Write on checks, stationery, books, cards, records, etc. Hundreds of uses for this amazing new writing kit. Complete with professional stylus

Only \$1.00

plus generous supply of silver or gold ink for just \$1.00 ppd. Order both gold and silver for just \$1.89 ppd.

**ORDER FROM**  
HOME SHOPPER 667 N. Fairfax Ave. DEPT. E-6  
Dept. Los Angeles, Calif.



# ELKS FAMILY SHOPPER



**WINDSHIELD DE-ICER.** This heavy plexiglas tool makes short work of ice and snow without scratching the glass. And here's two extras: an accurate compass set in the plastic and a key chain attached to handle. Plain or with one engraved initial, \$2.00 ppd. Discounts will be quoted in quantity lots. Bodine's, Dept. E, 444 E. Belvedere Ave., Baltimore 12, Md.

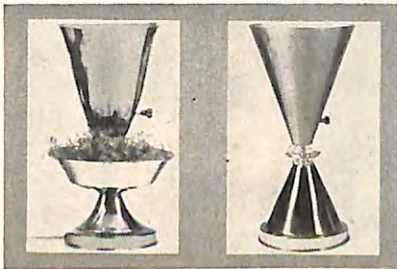

**TWO LAMPS . . .** distinctively shaped, wonderful for reading or beside the TV. Both are aluminum, reflector type. Planter Lamp holds magic plant that needs no water. 10" high, in rose, brass or blue finish. Hour Glass Lamp has many-faceted glass knob for decorative interest. 11 1/2" high, copper or aluminum finish. \$3.95 ea. ppd. Scott-Mitchell, Inc., Dept. 51PL, 611 Bway., New York 12.



## REAL ALLIGATOR WALLET — \$4.95

It's true! This fine wallet is crafted from genuine alligator, trimmed with real pigskin. Zippered bill compartment has secret, hidden section. 4-section plastic pass case. Card holder. Brown or honey shades. \$4.95 tax included, postpaid.

• FREE gift folder, "LEATHER MASTERPIECES" •

**MASTER LEATHER CRAFTERS**  
DEPT. H, 304 CHERRY ST., PHILA. 6, PA.

## DESSERT and COFFEE SET



Utterly charming for serving coffee and sandwiches or cake. Unusual oval-like shaped plate of white china strewn with delicately shaded Roses or Violets is gold-trimmed; has special recess to sturdily hold matching cup. No spilling or juggling with coffee on one knee, cake on the other. Perfect for buffet dinners, midnight snacks or dessert before TV or fireplace. Service for 4 (4 cups and 4 plates). Exceptional quality China, actually worth much more than our moderate price! Real VALUE, delight—\$4.98. **Guaranteed, of course.**

**NOUVELLE, LTD.** 227 W. Erie St., Dept. 266, Chicago 10, Ill.

# XMAS GIFTS

by STRAGO

## RAIN SUIT (OLIVE DRAB) NAVY TYPE RUBBERIZED COTTON for Best Waterproofing

LIGHT-weight, long-wearing, rubberized. Specially waterproofed fabric 2-piece utility suit. A must for Hunting, Fishing, All Outdoor work and Play. Extra roomy trousers with fully adjustable shoulder straps. Slip-over Parka with attached drawstring hood and adjustable sleeves, closes to the neck with sturdy metal snaps. Raglan shoulders. S, M, L, XL. (\$14.95 value) (Parka—\$4.39, Trousers—\$3.98) **SAVE—COMPLETE SUIT ONLY \$7.90**

## NOW the WADE-RITE WADER

Genuine Buna-S rubber, stocking-foot wader. Waterproofed, durable, lightweight, chest-high to give full front protection. Specially designed for comfort and fit. Suspender buttons. Putty color. Foot size 6-12. **STOUT AVAILABLE.** This is not plastic. Suspenders \$1.39. (regular \$13.95 value) **only \$8.49**

## LIGHTWEIGHT 100% WATERPROOFED 3/4 LENGTH PARKA

Ideal one piece noiseless slipover for Duck-hunting, Fishing, all sports. Made of a fine count, light weight cotton fabric. 100% water- and windproofed with rubberized, flexible backing which will not crack, rot, mildew or stick together, has attached roomy hood with drawstrings and full raglan sleeves adjustable at wrists. Large front pocket with specially designed storm flap offers extra built-in value. Plenty of room for movement in its full cut. Full 39" knee length. Color: Forest Green. Sizes, S, M, L, XL. **\$7.50** Our reg. \$13.95 value reduced to **\$7.50** Matching Overalls available at \$3.98

## TRENCHCOAT 100% DRESS GABARDINE \$15 VALUE SILVER GRAY

Save half on this \$15 value white supply lasts. With herringbone pattern lining. Raglan shoulders, shoulder straps, 2 big slash pockets. Belt all around. Water repellent treated, perfect rain protection. Sizes 34-46. Sizes S, Reg., L. **only \$7.90**

## GENUINE HORCO HYDE\* BOMBER JACKET

This genuine Horco Hyde Jacket is stronger than most leathers and will take rugged and long wear. Save dollars on this value. Heavy fleece lining, raglan sleeves, knitted bottom and cuffs, zipper front and breast pocket, 2 slash pockets, water repellent treated. Sizes S, M, L, XL. (in Brown only) **REDUCED TO \$8.98** (value \$14.98) **\* (R) Boys sizes 10-18 only \$7.98**

## ALL NYLON UTILITY JACKET

Ideal for golfing, sailing, fishing, skiing, all sports. Trim fitting, well-tailored. Waterproofed, raglan sleeves, zipper front, slash pockets, elastic cuffs and sides, arm-hole vents. Dark Green only. Reg. \$10.95 value). **\$6.98** S, M, L, XL. (Matching Removable Hood \$1.95) Postage paid with check or M.O. 95c more for C.O.D. Print name, address, size. 10 Day money back guarantee. **EXCHANGEABLE AFTER XMAS**

**STRAGO MFG. CO.** 874 Broadway (Dept. 6), New York 3, N.Y.

# FREE CATALOG!

BUY GENUINE

## Diamonds

From New York's Leading **PAWNBROKER**

**SAVE UP TO 50% AND MORE**

**SEE BEFORE YOU BUY!**

Tremendous savings on diamonds from unredeemed loans, bankruptcy sales and other below market sources. All reset in smart brand new 14 Kt. gold & platinum modern mountings. One of the world's largest selections. Every diamond graded according to nationally accepted system. Grading explained in catalog. You are 100% protected by a SWORN BOND guaranteeing quality and 10 DAY UNCONDITIONAL MONEY BACK GUARANTEE. Easy payment lay-away plan, and . . . see-before-you-buy plan available. Send coupon for FREE CATALOG. Established 1882. Our references: your own bank or any mercantile agency.



**KASKEL'S** 41 West 57th St.

New York 19, Dept. 567L

Send FREE CATALOG and Advice about DIAMONDS without obligation.

NAME .....  
ADDRESS .....  
CITY ..... STATE .....

# here's a PRACTICAL GIFT FOR DAD!\*



# RED HEAD

## ELECTRIC LAWN TRIMMER

This light-weight aluminum work-saver trims grass neatly right up to walls, sidewalks, trees, along borders, under shrubs—wherever it's difficult to reach with your lawn mower. Mows down tough weeds in a flash! Gives your lawn that clean, professionally-finished look in no time at all—and without the tedious hard work and aches and pains that go with hand trimming.

**ONLY \$19.95**

**HERE'S** →

what does the work—a powerful 10,000 RPM Westinghouse motor, coupled through a slip clutch to a safe, soft iron rotary blade. Protective guard; handy off-on switch; top quality components throughout.



## NOW AVAILABLE BY MAIL ORDER NOW

\*DAD—Clip this ad and leave it where the family will see it! Make sure you get a practical gift this Christmas.



Send check or money order—no COD's. Sent postpaid and guaranteed. **RED HEAD Trimmer**, Dept. C-11 302 Madison Ave., Covington, Ky.



**A GIFT SHE'LL TREASURE** is this imported set of unusual jewelry. Hundreds of tiny pieces of colored enamel are inlaid to form beautiful pattern of red roses in a jet black background. It's a centuries-old craft in Florence, Italy. Bracelet (6 links 5/8" wide) \$7.50, earrings \$3, the set \$9.50 postpaid (incl. tax). Add 35c Air Mail.

Money back guaranteed if not truly delighted. Dept. 8, 505 5th Ave., NYC 17.

**ALPINE IMPORTS**



## WE'RE 'A-GIN' HIGH PRICES FOR FINE GLOVES

That's why we offer Genuine Luxurious Deerskin Gloves at

MEN'S & WOMEN'S



**\$3.98**  
a Pair

**UNCONDITIONAL GUARANTEE:**

Your Money Back If You Can Match Them, Retail, for \$6.00.

THE SAME EXCLUSIVE FEATURES OF THE MOST EXPENSIVE GLOVES:

**DEERSKIN** Leather of Finest Tannage Full Cut with Super-Fine Stitching Rolled Seams, custom tailored to fit and feel right!

We Guarantee . . . These Fine Gloves Have Never Before Been Sold Direct-To-Wearer.

Timely Gloves, Inc. Gloversville, N. Y. Buy One Pair For Yourself, One For Your Wife or As A Gift. Two Colors . . . Egg Shell or Saddle.

OFFICIALLY RATED AS AN AID TO SAFER DRIVING



Deerskin Insures Better Steering-Wheel Control.

**WRITE TODAY**

Timely Gloves, Inc.

Box 249, Dept. 1410, Gloversville, N. Y.

Send immediately, on approval . . . pair(s) of genuine deerskin gloves at your direct-to-wearer price of: 1 pr. for \$3.98. I will pay postman plus few cents postage. If not delighted they may be returned within 10 days and full purchase price refunded. I have checked color and stated size. Color: Egg Shell  Saddle  Glove Size  Men's S-M-L-XL 8-8½, 9-9½, 10-10½, 11. Ladies' S-M-L 6, 7-7½, 8-8½.

Name \_\_\_\_\_

Street \_\_\_\_\_

City \_\_\_\_\_

State \_\_\_\_\_

(If you prefer, enclose check or money order and we'll pay postage.)

### A RARE BARGAIN only \$4.95



**STERLING SILVER** Cake and Pie Server with serrated, stainless steel cutting blade

GIVE IT WITH PRIDE for you give the finest! Not only a beautiful server for cakes and pies, but its sharp, serrated blade does the cutting, too. Pattern on 4" sterling silver handle is versatile, lovely with any silver set. \$4.95 postage paid fed. tax inc. Unconditional money back guarantee.

"For over a Third of a Century"

KYSETH JEWELERS

Clarion, Iowa

### FOR DISTINCTIVE AND UNUSUAL GIFTS

**Custom-Made Christmas Candles.** Just the thing for table decoration. Kit has two 6½" swirling tree candles with host of glittering sequins. Apply in any desired design for exciting creations. Trim-A-Tree Kit \$2.25 ppd



Send for **FREE GIFT CATALOG**

. . . showing interesting, unusual gifts from the far corners of the world. All moderately priced; many cannot be found in stores. Selections attractively wrapped and shipped promptly with satisfaction guaranteed. Address 575 Elm St., Westfield, Mass.

**The OLD WHIP SHOP**

## Keeps Your Windshield Free from Ice, Sleet, Frost!



### AUTO WINDSHIELD BIBS



Now you can park your car in winter's worst weather and keep your windshield free from snow, ice and sleet. Even your wiper blades are ready for instant action when you use this large plastic shield that goes on—or off—in 10 seconds! Standard, 5½ feet x 18", only 98¢; large size for wrap-around windshields — \$1.29, postpaid. 10-day money back guarantee. Send cash, check or money order today!

FREE—Catalog of Gifts and Gadgets!

Mrs. Dorothy Damar 332 DAMAR BLDG., NEWARK 5, N. J.

IN CANADA: plus local sales tax, checks payable par Montreal, 77 Vitre Street West, Montreal, Que.



for  
**AULD LANG SYNE**

For that worthy member who can point to 25 years of membership in the Elks here is a gift that he's sure to prize highly as a token of the many years he has been an Elk and for the whole-hearted warmth of feeling it expresses. Yes, 25 years IS a long time and well warrants recognition and there's scarcely a better way to show this than by giving that Elk one of these handsome, 10 kt gold, splendidly enameled red, white and blue 25 year membership pins. A Christmas gift unusual. 10 kt gold plated post and attaching button. Please order by number. 25 year pin No. 3—\$8.25. Price includes Federal tax. For N. Y. City sales add 3% tax. Delivery within 2 weeks. Order TODAY from THE ELKS MAGAZINE, 50 E. 42nd St., N. Y. City 17, N. Y. Sent ppd., on receipt of check or money order.

## ELKS FAMILY SHOPPER



**PERSONALIZED CLIPBOARD:** One of the handiest gadgets for home or office, styled with lots of eye-appeal. Clip in red, yellow, white or black with pastel boards, velour backed to protect furniture. One bold initial in gold and black. Queensize, 6½" x 11", \$1.95; Kingsize, 9" x 12½", \$2.95 ppd. Carol Beatty, 7410 Santa Monica Blvd., Dept. E-11, Los Angeles, Calif.

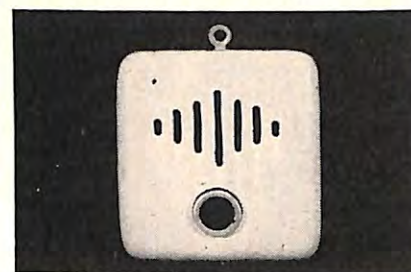

**PROTECT YOUR HOME FROM FIRE** with this low-cost but completely effective Plug-Alarm. This compact unit, just 3" high, is simply plugged into any standard outlet. At a temperature of 140°F, a thermostatic control sets off a loud, clear alarm. Safety lock prevents tampering. One in each room gives complete protection. \$6.95 ea. ppd. Karday Assoc., 220 Fifth Ave., Dept. E-1, New York, N.Y.

### TWO NEW DIFFERENT GIFTS



EASIER, RELAXED DRIVING

"Xtra Rest" Arm Rest—rest and comfort for years. Frame of aluminum, choice of red or black plate. Fits all cars. "Reposo" Leg Rest—a wonderful way to relax at TV in chair or rocker. Also makes a comfortable back rest used with pillow for bed patients. Light aluminum and washable Saran fabric.

\$2.95 Postpaid

No C.O.D.'s or Stamps please

JACKSON SALES CORP. Clearwater 12, Florida  
1305 N. Ft. Harrison



SO MUCH COMFORT FOR SO LITTLE MONEY  
\$4.75 or 2 for \$9.00 ppd.

### The Long and Short of it!



Anon Original by WIN-MOR of California  
Custom tailored robes for father and son . . . generously cut from cloud-soft white terry.  
Father's size—S, M, L & XL.  
Price \$22.50  
Son's size—  
2 to 4 years \$7.50  
6 to 10 years \$10.00  
Monogrammed in navy or red (State initial desired)  
Garments are exceptionally well sewn to insure long life.  
(Please state robe length and sleeve length—custom tailoring requires 2 weeks for delivery)  
No Win-Mor Garment is Sold Except By Direct Order From:  
WIN-MOR of California  
P.O. Box 38311, Dept. 5  
Hollywood 38, Calif.  
Check or Money Order. No C.O.D.s please. We pay the tax.



\$1.00 PPD

JOSEPH'S

TWO-IN-ONE, this wrought iron holder will attractively hold several flowers in the glass vial, and with vial removed, it becomes a candleholder. Consider this as an "extra" gift, prize or hostess present. Height 7", 4" wide at base.

Write for FREE GIFT CATALOG

809 OREGON ST. OSHKOSH, WIS.



# ELKS FAMILY SHOPPER



**RACKED FOR SPACE?** Let Hand-Dee Rack solve the problem of where to hang towels, drying stockings, lingerie, etc. When not in use, this polished, etched aluminum rack folds flat against the wall. Four arms, each 4" long, have looped ends for secure hanging. \$1.60 ppd. Jackson Sales Corp., 1305 N. Ft. Harrison, Clearwater 12, Fla.

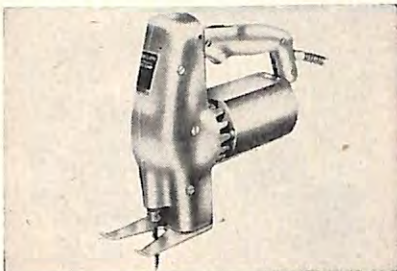

**7-WAY ELECTRIC PORTABLE JIG SAW** does the work of a rip, cross cut, coping, jig, scroll, band and keyhole saw. Rips and cross cuts 2 x 4's. Smooth, steady cutting is guaranteed. Built-in compressor blows sawdust away from guide line. With 5 different blades, \$48. Shipped on approval. Fine gift. Kapner Hardware, Inc., Dept. P-103, 452 E. Tremont Ave., New York 57.

**NEW! LOW-COST TRANSPARENT FURNITURE COVERS**  
**EXCLUSIVE! Made With ZIPPERS!**

Now! First time anywhere at popular prices! Sensational new ZIPPER Furniture Covers taper to the contours of your upholstery. Only \$3.95, up. Made of new soft transparent Firestone Velon. Heavy duty, long-lasting quality. Dust, dirt and liquids wipe off easily, completely. World's largest selection—over 150 styles and sizes—assure neat-fit covers to protect your furniture. Get FREE Catalog and Velon sample. Write TODAY! **HOUSE OF SCHILLER, Dept. E-1, 180 N. Wacker Drive, Chicago 6, Illinois**

**LOW \$3.95 AS**  
Send for FREE Catalog

**WHY REMAIN GRAY?**

There's no need to lose out on business and social opportunities because of the aging effects of gray hair.

**GOLD MEDAL HAIR-TONE IS THE SECRET**

This exclusive formula will give your hair natural-looking color no matter what color it was before turning gray. It is not a tint. Will not stain your hands or scalp. Won't streak or injure your hair. Apply just as you do hair tonic. Removes loose dandruff. Conditions the hair. Send now for 6 oz. bottle. Only \$5.00 postpaid. (Fed. Tax Incl.) No C.O.D.'s please. Money back if you're not delighted with results. Gold Medal Company, P. O. Box 601, Minot, N. D.

**GENUINE SHEEPSKIN CUDDLE RUG**

Because they lend glamour to any setting you'll give her that "Lap-of-Luxury" feeling with these deep, silky sheepskins to scatter beside her bed—before her fireplace—in her playroom. Cloud soft and snugly warm, they make cold weather rising a delight. They're not imitations! Each rug is a genuine, Brandeal selected, finest quality skin covering app. 8 to 9 sq. ft. In natural Honey Tone—\$11.95\*. In Cloud White—\$12.95\*

**ALSO:** Genuine Branded Calfskin Rugs—for den, hall or bedroom. 3 initial brand (specify initials) personalizes gift. Choice: white with black or brown. App. 5 sq. ft.—\$10.95\* Initials—\$2.00 extra.

\*Add 50c postage ea. No C.O.D.'s. Guaranteed

**FREE GIFT FOLDER**  
**BRANDICALF—Dept. Z15—157 Federal St., Boston, Mass.**

**IF you're a PIPE SMOKER—you'll love this!**

Unique pocket-size Phil-O-Matic tobacco pouch automatically fills and tamps pipes without opening pouch—just press the plunger. Visible tobacco supply remains fresh and moist. Prevents spilling and staining. Fine for the outdoorsman. Can use with gloves on—in wind or rain! Made of heavy vinyl plastic. Lifetime spring filler mechanism. Satisfaction Guaranteed.

Only **\$1.95**

Your initials in gold, only 25c extra. postpaid

Send for new Free GIFT CATALOG!

**THE FIRESIDE SHOP**  
905 Fireside Bldg., South Bend 17, Ind.

**100 Toy Soldiers \$9.00**

**Miniature ARMY, NAVY & AIR CORPS**

A "strategic defense command" of 100 plastic toys including 4 each: riflemen, infantrymen, bazookamen, marksmen, sailors, tanks, trucks, jeeps, battleships, cruisers and bombers; and 8 each: machine gunners, sharpshooters, officers, WAVES, WACs, cannons and jet planes. Each toy is completely assembled, designed to scale and measures up to 4 1/2". Send \$1.00 plus 25c handling for each set of 100 toys. Order several sets TODAY . . . kids love 'em!

Write for FREE catalog

**BODINE'S**  
501 E. Preston St., Baltimore 2, Md.

**FINGERTIP BINGO**

Does away with loose markers! Each card has colored cellophane slide player moves when his number is called. Ideal for home, party, club use.

Set of 6 cards, spinner, 75 call num- EXTRA CARDS bers, masterboard, instructions \$1.95 12 for \$3.00

WRITE FOR FREE CATALOG

**THE BURGESS HOUSE** 428-E South 6th St. Minneapolis 15, Minn.

## In Kits or Beautifully Finished



U.S. Pat. No. 2615565 No. 2623639

### Safe-Lock Gun Rack



### THE GUNS AND AMMUNITION ARE LOCKED IN

Handsome sturdy gun racks safely lock guns in attractive display. Large drawer locks up ammunition, pistol, cleaning gear, etc. Guns cannot fall or be taken out. One key unlocks drawer and guns. Children-proof, Foolproof.

4-Gun Rack 24"x28" (Shown) Finished \$19.95. In Kit \$11.50  
6-Gun Rack 24"x40" (Taller) Finished \$29.95 in Kit \$17.20

### 14 Pipe Rack

A beautiful pipe dream. Holds collection of 14 pipes. Has 3 airtight humidifier jar drawers, large accessory drawer; hangs charmingly, conveniently on wall.

14 pipe rack 13"x18" Finished \$12.50 Kit \$7.95  
29 pipe rack 18"x22" Finished only—\$26.50

### Color Slide Rack

For all size Kodachromes and Ektachromes. Now—all slides safely, handsomely filed on wall. Special plastic file tabs. Drawers remove to projector. Large camera accessory drawer. Finished only—in honey-tone knotty pine, maple or mahogany. Size 10"x24" (Shown) holds 700 slides, \$12.95. Double width 20"x24" holds 1400 slides, \$24.95.



Finished in hand-rubbed honey-tone knotty pine, maple, or mahogany. In Kits for easy 1-hr. assembly; fitted, drilled, sanded, etc.; simple instructions.

Finished racks express charges collect. Kits postpaid (add 10% west of Miss.)

Immediate delivery Money-back guarantee—No C.O.D.'s.

**YIELD HOUSE**  
Dept. EK 11-5  
North Conway, N.H.

## For You and Your Chicadee

**Cunning 3-Pc. Set SALT and PEPPERS "CHICKS IN A NEST"**



ONLY \$1.00 POSTPAID

So HAPPY in their little nest, they almost seem to chirp! . . . CHICKS are yellow—NEST Brown. Highly glazed imported china. Order now for yourself and for Xmas gifts. Really cute and different. Sorry, no COD's.

PERSONALIZED with any TWO first names on the chicks; Last name on the nest

Write for FREE Gift Catalog.

**HOUSE OF JENARO** Box 736, Dept. 812, Chicago 90, Ill.

## PUMPS OUT 300 GALLONS PER HOUR

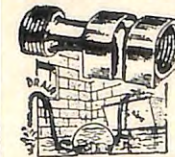

**DRAINS CELLARS, SWIMMING POOLS, FISH PONDS, BOATS, EXCAVATIONS, WELL-HOUSES, FLOOD AREAS. Lifts water 6 feet.**

New SPEEDY DRAINER solves your flood and drain problems. Ends back-breaking bailing and hand-pumping jobs. Pumps out all water, right down to floor. OPERATES WITHOUT ELECTRICITY. Just connect SPEEDY DRAINER to work, pumping out 300 gallons per hour. Made of lifetime brass; no moving parts to wear or jam. Be ready for flood emergency—order now. Remit only \$2.98 with order and we pay postage. If C.O.D. you pay postage. Money back guaranteed.

**MERIDIAN PRODUCTS CO.**  
366 Madison Ave., Dept. D-33, New York 17



**This Christmas Give Yourself—Your Friends This Blessed Gift of SLEEP**



Everybody loves this new **BLANKET SUPPORT** because it frees their feet from blanket weight. NOW they sleep quietly relaxed and awake refreshed. The difference is truly amazing! Ingenious folding arms make a cozy, restful foot pocket indispensable to uncomfortable sleepers. Relaxes tension that cause insomnia and irritations. Improved circulation eases rheumatism and foot cramps. Increases electric blanket comfort. Enjoyed by arthritics and the aged. Fits any bed. Arms fold down flat when bed is made. Praised by thousands of restless sleepers, doctors and hospitals. Tested and approved by "Foot Health Committee, N.Y.C." A Christmas gift guaranteed to please, or your money back. Send only \$3.98 plus 25c postage.

\$1 Higher in Canada. Duty Free

**BETTER SLEEP INC.**  
Dept. 466, New Providence, New Jersey

**SEWS LEATHER AND TOUGH TEXTILES LIKE A MACHINE**

With **SPEEDY STITCHER** Automatic Sewing Awl, anyone can quickly and skillfully sew or repair anything made of **LEATHER, CANVAS, NYLON, PLASTIC, or other heavy materials.** Sewes firm, even lock-stitches like a machine. Gets into hard-to-reach places. Specially made for heavy duty sewing on **LUGGAGE, FOOTWEAR, RUGS, AWNINGS, SAILS, SADDLERY, UPHOLSTERY, OVER-ALLS, AUTO-TOPS, SPORTS GEAR,** and other tough sewing jobs. Here's the handiest tool you'll ever own. Will save you many times its small cost. Comes ready for instant use complete with bobbin of waxed thread and 3 different types of diamond-pointed needles. Easy-to-follow directions will make you an expert in minutes. Extra needles and waxed-thread always available. Save money, send \$1.98 for postpaid delivery. If C.O.D., \$1.98 plus postage. **MONEY BACK GUARANTEE.**

**SPORTSMAN'S POST**

366 Madison Ave., Dept. A-398, New York 17



ONLY **198**



**AUTO EMBLEM** for license plates identifies the owner as MD, DDS, RN, pharmacist, member of Fire Dept., Auxiliary Police, Civil Defense, Masons, Moose, Eagles, Lions, Rotary, K of C or, of course, Elks. Of sturdy, cast aluminum, painted in correct insignia colors. Each \$1.49; two, \$2.50 ppd. Money-back guarantee. Your own design made-to-order (min. 50). **Sta-Dri, 147-57 Sixth Ave., Dept. 47X, Whitestone 57, N. Y.**



**SATIN RIBBON FOR CHRISTMAS PACKAGES**

In brilliant red or green! Also Royal blue, gold, white, light blue, pink, Nile green, orchid, silver, yellow, brown. 50 yd. rolls of each color. 50c each. That's only a penny a yard for a \$3 value! Approx. 1/2" wide. Minimum order, 2 rolls for \$1. No C.O.D.'s. Money-Back Guarantee. Rush color choice, remittance to: **BARCLAY GRANT & CO.** Dept. E-11 Locust Valley, N. Y.

**1c**  
A YD.

**PARKS YOUR CAR IN SECONDS AUTOMATICALLY — Works Every Time!**

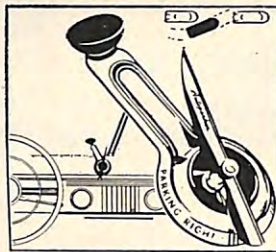

This "know-all" dial shows you how and when to turn the wheels and back up for a perfect curb-sidelanding. No practicing necessary. It works immediately. Attaches with suction cup to windshield without tools. Only \$1.00 postpaid. 10-day money-back guarantee. Send cash, check or money order today. **FREE** Catalog of Gifts and Gadgets.

Mrs. Dorothy Damar 331 DAMAR BLDG. NEWARK 5, N. J.

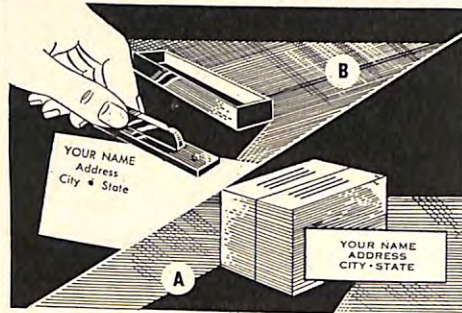

**Identify & Personalize—Everything**

Your name & address on checks, stationery, books, etc. Saves time, avoids errors. (B) **PRINTER**—\$1. Finest rubber stamp. Clear impression, automatic inking unit, self contained case. (A) **1000 Quality LABELS.** Gummed, padded—\$1. Send name & address (3 lines). Ideal gifts. Specify how many Printers & Labels; any 6—\$5. Cash, check, M.O. Approved Products, Dept. E-1155, 323 W. Florence Ave., Los Angeles 3, Calif.

**"MY GREY HAIR IS A NATURAL LOOKING COLOR AGAIN!"** says **JAN GARBER,**

Idol of the Airlines  
"TOP SECRET gives my grey hair a natural looking color!" says famous dance band leader Jan Garber. "I noticed results after just a few applications. And TOP SECRET is easy to use—doesn't stain hands or scalp. TOP SECRET is the only hair dressing I use."



**A FAVORITE OF THE STARS**



TOP SECRET has been a favorite with famous personalities for years. Exclusive formula imparts a natural looking color to grey or faded hair. Does not streak or injure hair; does not wash out. Send \$5.00 (Fed. Tax Incl.) for 6 oz. bottle. Postpaid. No C.O.D.'s, please. Money back if you're not delighted with results. Albin of California, Room 411, 1401-91 W. 8th St., Los Angeles 17, Calif.

**A GIFT HE'LL ALWAYS CHERISH**



Other gifts he will get but this, a handsome 10kt Gold, richly enameled Elks insignia is one he will treasure for years ahead. Like other official Elk emblem pins it is approved by the Grand Lodge. A truly fine example of jeweler's art and craftsmanship and a gift that will demonstrate your thoughtfulness. Illustration shows pin indicating 15 years membership in the Elks. Please order by number. No. 5 (above) 15 year pin, 10 kt gold, red, white and blue design. Post and attaching button gold plated. Price \$7.35. No. 4 slightly different design as No. 5 but with 10 year membership designation also \$7.35. Prices include Federal tax. Delivery within 2 weeks. For N. Y. City purchase add 3% sales tax. Order your gift pin today from **THE ELKS MAGAZINE, 50 E. 42nd St., N. Y. 17, N. Y.**

**ELKS FAMILY SHOPPER**



**GRANDFATHER'S KEY CHAIN.** Someone finally realized that grandpa is just as proud of the little ones as grandma and here's the happy result—a sterling silver key chain that holds 8 to 10 keys and as many discs as he has grandchildren. Chain, \$2.20 ppd. Each disc, engraved, \$1.10. Robin Hood's Barn, 680 High St., Dept. E, Westwood, Mass.



**HER OWN DOLL HOUSE** is the dream of every little girl and this one's a beauty. A 5-room, 3-story model, it boasts the latest in styling, inside and out; colorful walls, fireplace, oil paintings, "tile" bath . . . all ready for miniature furniture (not included). Sturdy board construction. 16" high, 21" wide, 9" deep. \$2.98 ppd. Mrs. Dorothy Damar, 720 Damar Bldg., Newark 5, N.J.

**SHOE SHINE KIT**

E-Z Shine Holders are made of strong aluminum. Detach from wall bracket. 3 changeable toe plates for men, women and children (for all size shoes). Chrome-like finish. C.O.D.'s pay postage. Look sharp at low cost. Guaranteed to give long, hard family usage.



Dept. B-11, WAYNE, PA.



**CHRISTMAS CARD HOLDER**  
Holds 100 Cards \$2.50 ppd.

folded with golden snow are the decorative keynote for this practical Christmas Card Rack. 40" long. \$2.50 ppd.



**E-Z GRIP PLAYING CARD HOLDER**  
Makes it fun to pick up the pile. Slip the cards in the holder and fan them out. No worry about spilling or showing your hand. 4 plastic holders (each a different color). \$1.00 ppd.

Write for Catalog  
**RMS INTERIORS** Dept. E 1146 S. Michigan Chicago 28, Ill.



# ELKS FAMILY SHOPPER



**LOVELY FITTINGS** for her handbag make a hit with any woman. These are especially handsome with a Petit Point floral design against black faille. Group includes: Address Book and Pencil, Cigarette Case (King Size or Regular), Comb and Mirror, Manicure Set. \$1.00 each or any 3 for \$2.85 ppd. Mastercraft, 212K Summer, Boston 10, Mass.



**ENGRAVED COASTERS** in new Caronite are a happy gift find for the host or hostess who loves accessories that are smart and distinctive. This handsome material won't scratch, is washable, durable, and alcohol proof, and it takes deep engraving beautifully. Assorted colors, 2 3/4" sq. Print name or initials. Set of 8, \$2.00 ppd. International Gift House, Box 509-E, Culver City 42, Calif.

## Real Xmas HOLLY

**Little Giant Box**  
15 Large Sprays in Splendid Gift Box with FREE Mistletoe  
Ppd. \$2.50

**Decorator Box**  
Plenty of Holly, Western Greens and FREE Mistletoe  
Ppd. \$3.95

**Special Holiday**  
Asst. Box 5 lbs. Asst. Holly, Western Greens, Pine Cones and FREE Mistletoe  
Ppd. \$5.95



Fresh from the Northwest Forests into your home to give true holiday spirit. Rich green, red berried, fresh English Holly. Use as centerpiece, room or window decorations, corsages or use on packages. Everyone will thank you for this unusual gift.

Write for Catalog

**NORTHWEST CORNER STORE**  
P.O. Box 1138, Longview 8, Washington



## PLAIN and FANCY IMPORTS

Rugged, shock-resistant model has easy-to-read radium dial, sweep second hand. (In men's, women's, or child's size—specify.) \$8.99 Tiny fashion piece has colored stones, matching suede band in pink, cocoa, blue, Kelly green or white with black band. \$11.99  
Prices incl. tax, D.D. EACH WITH YEAR'S WRITTEN GUARANTEE.

**NASSAU JEWELERS, 200 West 34th St., N.Y.C., N.Y.**



### GENUINE DEERSKIN GLOVES

For comfort and durability, no other leather takes the place of deerskin. Washable in lukewarm water and mild soap, without injury to softness. Cream color.  
Fine tailoring and simplicity of ladies' glove makes it ideal for dress or sports. Palms stitched inseam, backs outseam, 5 1/2 to 8 graduated half sizes. \$5.75 ppd.  
Men's neatly tailored dress glove of accurate fit, perfect for driving. Nylon stitched outseam, cut over one piece pattern. 7 1/2 to 11, \$5.25 ppd.  
Free folder of deerskin jackets, gloves, mittens. Prompt Del. Mich. Res. Add 3% Tax.

**SHORTER'S INDIAN CRAFT** Dept. E5  
Petoskey, Mich.



### Gleaming Evergreen Fir Cones

### Metalized Christmas Ornaments

Nature's own beauties! Douglas fir cones triple dipped in gleaming GOLD and SILVER—ready to hang on tree. Striking as table centerpieces, door, window and fireplace decorations. Box of 12 large fir cones, hand dipped and plasticized for a lifetime of beauty only 98c and plasticized for a lifetime of beauty only 98c and plasticized for a lifetime of beauty only 98c and plasticized for a lifetime of beauty only 98c. Original GIFT! Christmas delivery assured. Order now.

98c

**EVERGREEN CONE CO., Dept. E**  
1222 N. Proctor Tacoma 6, Wash.

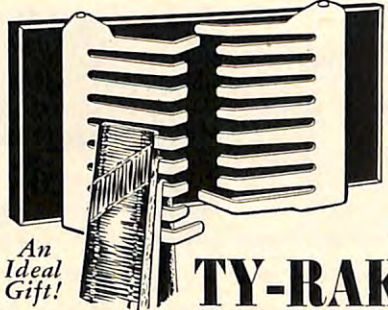

An Ideal Gift!

## TY-RAK

The new, smart, space-saving TY-RAK holds 18 ties neatly, and enables you to quickly select your tie (or belt). Arms of polished metal are hinged for easy access and removal. Easily attached. An exquisite gift of modern good taste for every man. only \$1.95 ppd.

36 tie size \$3.75 : 54 tie size \$4.75  
**SUTTON PRODUCTS CO.**  
(Mfr's. since 1946)  
P. O. Box 365, Sun Valley, Calif., Dept. E-115

### ON-THE-ROCKS

These glasses, engraved with a three-letter monogram, would be a handsome gift for a bride and groom. The jumbo size will delight a lazy host because he'll be able to relax at the normal refill time. They're fine, of course, for whisky and soda, and double Old Fashioneds.

Set of 6.....\$9.75

underline last initial

Sorry, no C.O.D.'s. Write for Free Catalog!

### EUNICE NOVELTIES

(since 1940)

Box 41, Rego Park, New York



## THE BUSINESS GIFT THAT SHOWS REAL APPRECIATION: Famous Wisconsin Cheese

**Pack No. 5** A truly representative assortment of fine cheese aged to perfection, contains Alpine brand swiss, brick, cheddar, baby gouda, dessert, blue cheese roll, smoky roll and wine cheese. Net Weight Over 4 lbs. Post Paid..... \$6.55

### Free PLASTIC CHEESE PRESERVER BAG AND BEAUTIFUL FULL COLOR BROCHURE SENT ON REQUEST:

1. Not sold in stores.
2. Enclose check or money order with all orders.
3. Prices include guaranteed safe delivery anywhere in U.S.A.
4. We will enclose a gift card bearing your name and make shipment in time for Christmas.

MEMBER: WIS. GIFT CHEESE SHIPPERS ASSOCIATION.

**THE SWISS CHEESE SHOP**  
BOX 4294 MONROE, WISCONSIN



## BUY AUTOS BY THE 100 . . .

Thousands of playful auto and truck combinations to give any youngster loads of fun day after day. He buys, sells, trades, decorates a pack of 100 molded autos and trucks in appealing assorted colors and body styles. A big bundle of 100 cars will be right at home in and around those unusual toys. Each car approximately 2" long. Big value . . . 100 cars . . . \$1.00 ppd. Carol Beatty, Dept. 511-W, 7410 Santa Monica Blvd., Los Angeles 46, Cal. FREE GIFT CATALOGUE included.

## KEEP CESSPOOL TROUBLE AWAY



WITH NORTHHEL

### Suburban & Country Dwellers

**NORTHHEL** Reactivator keeps septic tank and cesspool clean. A bacteria concentrate breaks up solids and grease—prevents overflow, back-up, odors. Regular use saves costly pumping or digging. Simply mix dry powder in water, flush down toilet. Non-poisonous, non-caustic. Guaranteed to reactivate septic tank, cesspool. 6 mos. supply (23 ozs) only \$2.95 ppd. Northel Distributors, EM-11, P. O. Box 1103, Minneapolis 1, Minn.



## NEW SILICONE IRONING BOARD COVER Cuts Ironing in Half!

Saves Your Time  
Saves Your Back!

Now—do ALL your ironing in half the time with Mrs. Damar's amazing new Silicone Ironing Board Cover. Reflects heat and makes one-side ironing sufficient. Scorch resistant, never needs laundering and wipes clean. Fits all ironing boards. Only \$1.00, postpaid. 10-day money back guarantee. Send cash, check or money order today. FREE—Catalog of Gifts and Gadgets.



only \$1 POST PAID

Mrs. Dorothy Damar 333 Damar Bldg.  
Newark 5, New Jersey  
IN CANADA: plus local sales tax, checks payable par  
Montreal, 77 Vitre Street West, Montreal, Que.



### FAMOUS BABY GIFT

Which everyone seems to be demanding. Five of America's top 50 corporations present NAME DATES to their employees when they have a child. Sized for an infant's first shoe. NAME DATES are made from the finest baby elkskin obtainable. Hand lasted on genuine oak lasts. Baby's first name and date of birth engraved in durable 24 carat gold leaf. Guaranteed not to wear off. Packaged in handsome gift box and shipped anywhere, with your gift card enclosed, for only \$2.98 ppd. Allow 2 weeks for delivery.

NAME DATE SHOE CO. Dept. E-11, P.O. Box 1503  
New York 17, N. Y.

**ITALIAN ACCORDIONS**  
**special DISCOUNT**  
TO MEMBERS OF THE  
**ELKS** 5-DAY FREE TRIAL

"PAY AS YOU PLAY"  
Small Down Payment  
As little as  
**\$10** per month

**DIRECT from Importer to You!**  
SATISFACTION GUARANTEED, or your money back! NOW you can save up to 50% by direct purchase from America's leading distributor of famous genuine ITALIAN ACCORDIONS.  
Send for FREE Illustrated Catalog!

**ACCORDION MANUFACTURERS & WHOLESALE OUTLET**  
2003 West Chicago Ave. Dept. K-115 Chicago 22, Ill.



### SAFETY GLASSES CASE!

Saddle leather case. Stays in your pocket. Spring clip holds glass firmly in pocket or on auto sun-visor. Finest workmanship, best quality tan colored saddle leather. Eliminates wear and soil to clothes. Protects glasses from normal breakage and loss. Wonderful gift item! Model 236, Glasses Case—\$1.50. Model 237, Glasses, Pen, Pencil Case—\$2.00. In Calif. add 3%. Money back guarantee. NELSON'S, Dept. E-115, Sierra Madre, Calif. No C.O.D.'s. Send for Free Gift Catalog.



### FILTERS OUT FURNACE DIRT

Wonderful news for you who have hot air registers! Disposable, non-inflammable fiberglass air filter pads fit into all grill registers . . . catch furnace dirt, dust, grease, grime. Prevents soiling of walls, furniture, drapes. Saves work, cleaning bills. Won't interfere with circulation of your warm air heating system. Easy to install—just cut to size with scissors and fasten to underside of register. Box of 10 sq. ft., only \$2.49 prepaid. No C.O.D.s.

HUSS BROS., 800 N. Clark, Dept. 7, Chicago 10

**Merry Xmas TIES**

Merry Ties for Merry Guys. We bet you can't wait until Christmas to give him this one. They're all bright Xmas red covered with crazy, colored sequins, stars, snowflakes and whatever is handy. But don't ask for two alike—we can't make 'em that way. Fun for parties—dare him to wear his to the office. All are top quality pebble-weave silk poplin—good for next year—and next.

Fore-In-Hand . . . \$1.59 ea., 2 for \$3.00  
Bow Tie . . . \$1.00 ea., 3 for \$2.85  
Western Bow Tie \$1.59 ea., 2 for \$3.00  
All Postpaid, order today from  
RED OAKS, Dept. 181-P, Winnetka, Ill.

1000  
Name & Address  
Labels \$1.00

Mrs. Arthur H. Robinson  
1035 Thurston Avenue  
Rochester, New York

Your name and address printed on 1000 fine quality gummed labels, PACKED IN PLASTIC BOX. Use them on stationery, checks, books, greeting cards, records, etc. Your choice of 3 lines printed on fine quality gummed paper. 1000 labels for only \$1.00 postpaid. Six orders for \$5. THIS IS A SPECIAL OFFER. A sensational bargain. Ideal for gifts. Makes a wonderful, useful present. Satisfaction guaranteed. Handy Labels, 1106 Jasperson Building, Culver City 1, California.

**For ELKS—the Gift unusual**

Give your favorite Elk one of these 10kt gold, beautifully enameled red, white and blue Elk insignia pins. It's a life-long gift that he'll proudly wear while always remembering the giver. Post and attaching button gold plated. Please order by number. No. 7 plain pin, no jewel, ppd \$7.35. No. 7S Same as 7 but set with one genuine blue sapphire, \$11.00. 7A Set with genuine diamond, \$20.15. 7B Same as 7A but containing larger diamond, \$28.40. Prices include Federal tax. Order your Christmas gift pin TODAY. Delivery within 2 weeks. For N. Y. City purchase add 3% sales tax. Dept. 5, THE ELKS MAGAZINE, 50 E. 42nd St., N. Y. City 17, N. Y.

## ELKS FAMILY SHOPPER



**DOLL-R-BILL or BILLIE.** Present your gifts of money with a light touch this Christmas. This amusing cowboy, cowgirl pair wear your money as their chaps! Bodies are carved of wood with hand painted winsome faces. Doll-R-Bill has a lariat, Billie, a bright red scarf. \$1.00 ea. ppd. Miles Kimball Co., 99 Bond St., Oshkosh, Wis.



**MR. ROBOT, the Mechanical Man,** is sure to thrill jet-and-atom youngsters with his real robot design and action. Made entirely of steel, he operates on a spring mechanism, striding forward when you turn the key and emitting real-looking (and entirely safe) sparks. 8" tall. \$2.98 ppd. Medford Prod., Box 209 Cathedral Station, Dept. E, New York, N.Y.

**Play Right Away!**

**ANY INSTRUMENT**

Now it's EASY to learn ANY INSTRUMENT—even if you don't know a SINGLE note now. No boring exercises. You play delightful pieces RIGHT AWAY—from very first lesson! Properly—by note. Simple as A-B-C. You make amazing progress—at home, in spare time, without teacher. Only few cents per lesson. 900,000 STUDENTS!

**FREE BOOK** Shows how easy it is to learn music this modern way. Write for it. No obligation; no salesman will call upon you. U.S. School of Music, Studio A10511, Port Washington, N.Y. (57th year).

**KEEP YOUR MONEY SAFE**

in a **CLIP-ON WALLET**

Breast wallet won't slip out of pocket. 3 1/2 x 7 inches. In Saddle Leather and Leather covered clip, 3 compartments for bills, cards, identification, etc. Beautifully Gift Boxed. \$5.00 ppd.

ACCESSORY OFFER: Combination Leather clip-on pen-pencil and eyeglass case. Also Gift Boxed for only \$2.00 ppd.

TERRY PRODUCTS, Dept. E, Box 581, Merrick, N.Y.



# ELKS FAMILY SHOPPER



**HOLIDAY ENTERTAINING** is a real joy when you have all the conveniences. For instance, these Drink 'n Snack Coasters. Glass fits into a table-protecting coaster with a rim that holds cookies or cocktail snacks. No awkward juggling for your guests. A good gift, too. Plastic coated, set of 10 is \$1.15 ppd. Bancroft's, Dept. EL639, 1112 So. Wabash Ave., Chicago 5, Ill.



**ANGEL ON THE MOON** expresses charmingly the wonder of Christmas. Blissfully asleep on a gold moon swing, lies a doll in gay, green or red checked pajamas. With lovely hand-painted face and downy hair, she's an irresistible angel. 9" overall. This is one gift you'll want to hang on the tree, unwrapped. \$3.50 ppd. Craft Shop, Inc., Dept. EK, Cambridge, N.Y.

**RELAX IN**

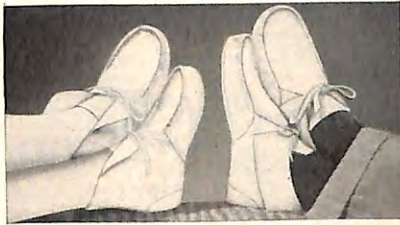

**PATAKWA MOCCASINS—Ideal Gift** from the Indian Reservation Country of soft, washable suede cowhide, with flexible padded soles. **BLISS TO WEAR** indoors or out with cuffs rolled up or down. **HANDCRAFTED** in Natural, Turquoise, Brown, Red, Em. Green, Golden Corn, Russet, Indian White. **FOR MEN AND WOMEN** in sizes 4 to 8. . . . . \$4.95 in sizes 9 thru 12. . . . . \$5.95 **FOR CHILDREN** too, in natural or brown only. Sizes 5, 7, 9. . . \$2.95 Sizes 11, 13, 2. . . \$3.95 Send cash, check or m. o. For COD's send \$2 deposit. **Immed. delivery. Satisf. guar. Gift orders carefully handled.** Box 4035, Dept. EP **OLD PUEBLO TRADERS** Tucson, Arizona

## Useful Leather EYEGLASS REST

Spec-tacular spot to rest your specs is this new Eyeglass Rest. Fine gold tooled leather covers the sturdy steel frame, while the padded moire lining absolutely prevents scratching. Order in choice of 4 fashion-right colors—Pink, Turf tan, Black, or Gooseberry Green. Gift Boxed.

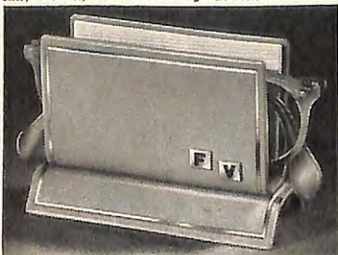

Only \$2.95 ppd.

(Initials 25c extra per letter.)

Write for FREE Gift Catalog

**HERE'S HOW** Dept. EK-11 27 E. 22nd St., N. Y. 10



## TURN ABOUT REVOLVING SHELF

for Refrigerators & Cupboards  
TURNABOUT fits readily into your refrigerator or cupboard, revolving easily and instantly, to put whatever you want at your finger tips. Washable and sturdy, a boon at the bedside, in the nursery or patio, as a Lazy Susan, or even for "Scrabble". Nothing else has so many uses as TURNABOUT. Every home needs not just one, but several.

An excellent gift item!  
only \$2.79 ppd. (or 3 for \$7.00)  
Order several for Christmas giving!  
**HOUSE OF MORGAN** Dept: E-115  
238 So. Mariposa Avenue, Los Angeles 4, Calif.

## new crop PECANS . . . in colorful Mexican



## FIESTA BASKET

Big Stuart and Success Pecans, washed, polished and machine graded.  
Shipped Postpaid

10% disc. on 5 or more baskets. Send gift list and personal or business cards. We do the rest.

**FREE!** . . . Illustrated color folder on gift boxes and 1 lb cellophane bags of Pecan Meats.

**DEEP SOUTH PECAN CO., Dept. EM, Biloxi, Miss.**

5 lbs. #1 grade \$6 (Mammoth)  
5 lbs. #2 grade \$5 (Jumbo)

## Personalized Gifts of Sterling



## WHEN WAS JOHNNY BORN?

That's no problem for the Mom or Grandmom with this fascinating birthdate bracelet. Name and birthdate of each child is engraved on separate silver disc, attached to silver bracelet. Specify names and dates. Orders shipped within week. Bracelet—\$1.10; Each Disc—\$1.10. Prices inc. tax and postage. No C.O.D.'s please.

## Robin Hood's Barn, Inc.

Dept. K115, 680 High St., Westwood, Mass.



## Perpetual Calendar — \$1

Now you can carry a key-chain calendar that's never out of date! Tells at a glance the day of the week your birthday will be . . . and all the holidays too. Plan important dates from now through 1980. Silver dollar size . . . smartly etched in black . . . gold plated. An unusual, practical trinket . . . an ideal gift for anyone. *You must be pleased or your money back!* Only \$1, postage paid. Six for \$5. ORDER PERPETUAL CALENDARS from Sunset House, 823 Sunset Building, Hollywood 46, California.

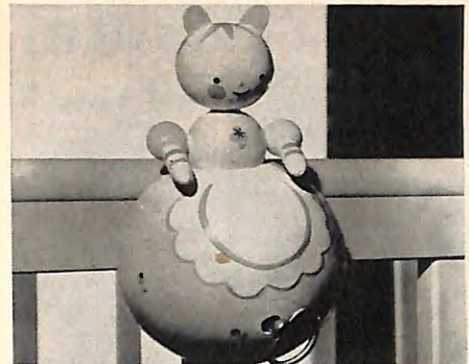

## MUSICAL KAT

Your favorite small person would gurgle with delight at this. Carved from hardwood high in an Alpine village, painted in pastel shades and fitted with the finest Swiss musical movement playing "BRAHMS LULLABY". A big satin ribbon ties him in place. A turn of the key makes him play. Choice of KITTY KAT (illustrated) or KLOWN. 6" high. \$4.95 Ppd. . . . .

Ask for free catalog of imported merchandise.  
**The OLD MEXICO SHOP**  
E SANTA FE, NEW MEXICO

Gifts that will Please your Customers and Associates

## IMPORTED ENGLISH PLUM PUDDINGS



Nobody makes Plum Pudding like the English. The chances are, though, that you and your friends have never tasted one of these traditional holiday treats, because they seldom are obtainable in this country. PEEK FREAN'S English Plum Pudding is the tastiest, most flavorful one we were able to locate in all of Olde England, and we've brought it to you for your enjoyment or for gifts that are sure to be delightfully different. 2-lb. tin, gift boxed, only \$3.00 pp. in U.S.

## IMPORTED BISCUITS, TOO

English biscuits (cookies to you) are delicious. Two popular gift selections are the Oxford Drum enameled tin, 1 lb., 15 oz. of assorted fancy biscuits, \$3.50, and Royal Scotch Shortbread in Tartan Plaid tin, 12 3/4 oz. \$3.00. Prices postpaid in U.S.

Write today for our "Company Gift Plan" for your Customers, Clients or Employees.

## MID-LAKES IMPORTERS

Dept. 103 P.O. Box 789 Evanston, Illinois

## AMAZING NEW PIPE . . . THE IDEAL GIFT!



**wagar**  
Patents Pending

TARS TRAPPED in the FILTER, Can't Reach the Lungs



**SMOKERS LOVE IT!** Can't spill hot ashes! Smoke in wind or rain! Can't burn clothes or automobile upholstery!

Tomorrow's Pipe! . . . Today! Provides clean, DRY, cool smoke MINUS THE HOT TOBACCO TARS that normally go into the lungs. Remarkable lifetime "cooling tower" condensing filter traps the tars to be wiped off the filter with a tissue. A WONDERFUL GIFT for any man! \$5.00 postpaid. Prompt shipment. Order from WAGAR PIPE, P. O. Box 2321, Houston, Texas.



## Elegant 18th Century Silver WATER PITCHER



ONLY  
**\$13.95**

Tax Inc.  
**ORDER NOW!  
WE PAY POSTAGE**

This beautiful silver reproduction will be treasured by you through the years with pride. Heavily silver plated on copper, with a gleaming high luster finish. 11" high, capacity 2 quarts, comes complete with ice stopper. On four English Rosebud feet.

**EXCEPTIONAL VALUE!! \$13.95**  
(reg. \$21) . . . shipped gift wrapped, postpaid.

**MONEY BACK GUARANTEE**

• Send for **FREE 12 PAGE CATALOG**

**Croydon SILVERMART, LTD.**  
Dept. E-11, 805 Lexington Ave., N.Y. 21, N.Y.

## Spruce ELECTRICAL MANICURIST



**For perfect manicures at home**

An ideal Christmas gift! Fast, gentle, safe . . . and so easy to use! In less than 10 minutes Spruce gives a beautiful manicure.

It shapes, buffs and cleans nails . . . whisks away excess cuticle . . . makes nails healthier, hands more beautiful. Erases corns and calluses from feet, too.

Ivory color, 4 1/2" high, 5 1/2" dia. Full set of attachments . . . shaper, buffer, cuticle lifter, cuticle brush, callus eraser. Operates on 110 V AC. Guaranteed to satisfy, or full refund. On market since 1938, many thousands in use.

Only \$24.95 complete, factory to you, postage paid anywhere in the world. Or send \$2.00, balance COD.  
**ORDER NOW or write for free descriptive literature.**

**ABAR MFG. CO.**  
8820 Woodland Ave.,  
CLEVELAND 4, OHIO

- Nail Shaping
- Cuticle Lifting
- Cuticle Whisking
- Oil Massaging
- Callus Erasing
- Nail Buffing

**Fully Guaranteed**  
**\$24.95**



**FISHERMAN'S  
BEST  
FRIEND**

At last a tool that every fisherman and sportsman, on land or sea, will cherish. Replaces that multitude of tools and gadgets all fishermen have scattered through their tackle boxes and can never find when they need them. It's designed as 12 tools in one but adaptable fishermen will find scores of uses for the Fisherman's Friend. Imported stainless steel with Genuine Leather Carrying Case. Attach to belt or carry in pocket. In attractive gift box. **\$6.95**. In Calif. add 3%. **NELSON'S**, Dept. E-115A, Sierra Madre, Calif. Send for free gift catalog.

for the wee housekeeper.

### DOLLY'S OWN LINEN

set consists of . . .

1. Cotton flannel blanket in gay plaid or print with satin edge.
2. Matching percale sheet and pillow slip.
3. Pillow, terry bath towel, face cloth and bath mat.

Predominating colors: Blue, Pink, Green and White.  
**PRICE: \$3.50 Set (Seven pieces)**  
NO C.O.D.s please—We pay the tax.

order direct from  
**WIN-MOR of California**  
P.O. Box 38311, Dept. S  
Hollywood 38, California



## Most Brilliant Gem on Earth!

More sparkle! More fire! A miracle of modern science! Looks exactly like a fine \$1,000 African mined gem expertly cut in 58 facets. Dazzling, full carat lady's ring, set in 14K. gold, only \$54.00 (tax incl.). Superb men's and ladies' rings in all carat sizes. Easiest of EASY PAYMENTS — as little as \$4 per month. Let us send you the full story of the amazing KENYA GEM . . . Write today for Free Booklet! Kenya Gem Corp. Department 318, Philadelphia 44, Pennsylvania.



## FLEXIBLE PLASTIC Dollhouse Dolls

Children love—and learn—with these almost human dolls. Soft plastic bodies can be bent into 1000 lifelike positions. They sit, stand, kneel, dance, etc. Hand painting and authentic handmade costumes add to realistic appearance. Washable—durable.

4 1/2" Father, Mother; 3 1/2" Son. **\$4.00 PPD.**  
Daughter in Dollhouse Box  
10 pc. set illustrated—**\$10.95 PPD.**  
No C.O.D.'s Money Back Guarantee

**FREE CATALOG shows over 70 dolls**  
**Flagg Flexible Dolls • Box E115, Jamaica Plain, Mass.**



## Santa's Best Gift for Your Dog

One sniff of this colorful doggy gift box, and your pet will know it's for him! Give your dog luxurious comfort, relief from scratching, restful sleep in its soothing cedar aroma. Kills fleas and doggy "B.O." So enticing he'll forsake chairs and sofa. Long-lasting. **Flea-Scat-Pad**, 15x28 in. **\$3.49**; Super size, 28x36 in. **\$4.98**.

**Kitty Cootie-Chaser** the Pad for Cats—hear pussy purr in luxury and revel in the catnip aroma of this comfortable bed. Kills fleas and lice. 14x18 in. **\$2.49**.  
**SEND NO MONEY**—Order C.O.D., or send check, and we'll pay postage. **Money-Back Guarantee**  
**SUBBURY LABORATORY**, Box 294, Sudbury, Mass.

## ELKS FAMILY SHOPPER



**SHOE ASHTRAYS.** From India come these colorfully enamelled brass ashtrays, handwrought. The engraved design is inlaid skillfully to give a pleasing mosaic effect. Nice and deep to keep ashes from blowing. Use them as individual trays. Set of 6, \$2.95 ppd. Seven Seas Import Guild, 1717 Westwood Blvd., Dept. E, Los Angeles 24, Calif.

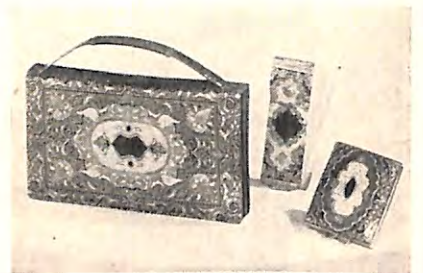

**TREASURES IN LEATHER**, hand-tooled in Venice. This handbag and accessories trio for dress occasions gets its strikingly rich effect from the intricate gold pattern on a ruby-red background. The leather glows with a jewel-like tone. Bag, 8 1/2" x 5", \$16; compact, \$5; case with tortoise shell comb, \$3. Set, \$22 including tax. **Alpine Imports**, Dept. E, 505 Fifth Ave., New York, N. Y.

**SANTA goes WEST for BUCKETS of ARDEN CHEESE**

Four 4 1/2" Glass Lined Mahogany Wood Buckets filled with the best 4 varieties of Arden Famous Flavor Fresh, Taste Tempting cheeses. The finest in the country.

The four 9 oz. buckets (replicas of the old west) are highly decorated with shiny brass bands and handles. Have many after uses. Packed in a beautiful tooled leatherette covered, re-usable Gift Box. Gold Embossed with Western Motif. An unusual, really exclusive LASTING GIFT.

**BY MAIL ONLY \$7.25 PER BOX.**  
(Please add \$1 for mailing and handling.)  
**WRITE FOR LOW QUANTITY DISCOUNTS**

**BENNER GLASS CO.**  
170 SAN FERNANDO RD. • LOS ANGELES 31, CALIF.

Keep A Neat Kitchen

### NEW! SOAP PAD HOLDER

**\$2.25 Postpaid**

Of fine white china it holds in-use soap pad in easily cleaned dish at top—dispenses new pad at bottom. Holds generous supply of S.O.S. or Brillo pads. 6 1/2" x 3 1/4" x 2 1/4", it hangs or stands. Colorful floral design.

Send For Free Gift Catalog

**THE ADDED TOUCH (Dept. E 11) Wynnewood, Pa.**



# ELKS FAMILY SHOPPER



**OVEN TOAST** at your table in the modern manner. New Electric Toaster lets you toast your favorite topping—butter, cheese, cinnamon—right into the bread. Use it to heat up coffee cake, bake frozen waffles, prepare brown 'n serve rolls, etc. Smartly styled in aluminum, \$9.95 ppd. The Adobe Kitchen, Dept. EL, Box 4035, Tucson, Arizona.

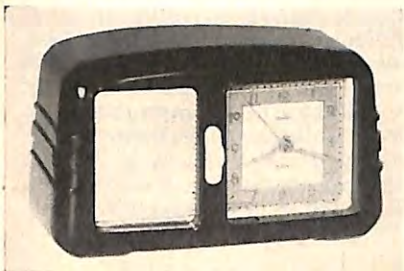

**MUSICAL ALARM CLOCK** wakes you gently to the tune of "Oh What a Beautiful Morning". It plays for 3 minutes for sleepyheads or you can silence it with the little knob. The case, a miniature replica of a clock-radio, is 4 1/2" long, 2 1/2" high in ivory or mahogany plastic with gold colored grille. Luminous dial. \$10.95 inc. tax. Kaskel's, Dept. 679, 41 W. 57th St., New York 19, N. Y.



## WOWEE! 50 TOYS—\$1.00

Imagine! 50 full dimension scale model cars and air-planes; U.S. fighters, supersonic jets, multi-engine transports, bombers, service cars, tow-trucks, highway vans, busses, cars. PLUS 10 more toys free including tiny tools for your Jr. Mechanic. 60 toys in all, fully assembled, made of colorful break-resistant plastic. Loads of holiday fun for youngsters 4-80. End to end they measure 10 feet! ORDER NOW! Send only \$1, plus 10c postage (tot. \$1.10) for each set, gift boxed, or \$3.75 for 4 sets post-paid. Rush order to: LARSANS, 4238 Harwood Ave., Dept. TC-11, Cleveland 21, Ohio.

## Elk's Pocket Knife with 2-color Emblem

Post Paid . . . . . \$4.95

Deep etched Chromic-Oxidized finish. Finest quality Swedish Stainless Steel Blades. Three blades and nail file. Handle is 3 1/4" long.

Send check or money order to

**WM. A JOHNSTON**  
1522 N. W. Thurman St.  
PORTLAND 9, OREGON



## WROUGHT IRON SWITCH PLATES

**ATTRACTIVE PRACTICAL and DURABLE electric switch ornaments.**

Designed to add warmth and beauty to the walls of any room. These handsome black wrought iron scrolled-framed plates fit over any wall switch or outlet. Give added protection to walls from finger marks. Ideal for any room—Living Room, Kitchen, Bed Room, Den, Foyer, etc.

• 1 Single Switch \$1.35 ea. • 2 Trip Switch \$1.95 ea. • 3 Double Switch \$1.35 ea. • 4 Double Switch \$1.65 ea. • 5 Combination Switch and Outlet \$1.95 ea.

Other types available including Despard Plates No C.O.D.'s please. We pay postage. Money refunded if not delighted. Order NOW!

• Write for FREE Gift Catalog •  
**Laurie & Co.** Dept. E-10, 507 5th Ave., New York 17, N. Y.

## CUTOUT PALS...

Delightful fun for children of all ages! These clever, life-like WARNER BROS. cartoon cutouts are in gay colors up to 18 tall. Easily applied to walls, lamps, furniture, etc.—pkg. includes special adhesive, ideas for use, plus 6 entertaining bedtime stories. 24 cutouts and stories—\$3.98 Ppd. Money-back guar. Please no C.O.D.'s.

**P. R. MAC LEAN ENTERPRISES**  
1590 Cross Roads of the World  
Dept. EM-11—Hollywood 28, Calif.

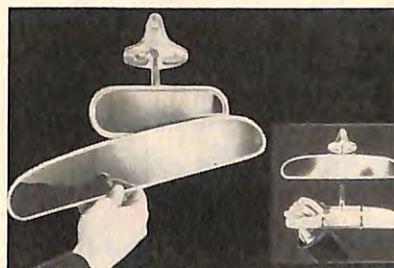

## NEW! SEE-ALL CAR MIRROR

Clip this huge 14" long mirror on your present inside car mirror and triple your visibility. See left, right and center at once—no head turning. Eliminates blind spots. Pass, pull in or out or park with safety. Non-distorting, glare-proof mirror fits over all types of car mirrors without tools. Clips furnished. Send \$2.49. Money-back guarantee. STA-DRI Co., 147-47C 6th Ave., Whitestone, L. I., N. Y.

NO BETTER  
GIFT for  
an ELK



You could not choose a more appropriate gift for an Elk than a copy of the handsomely bound, 432-page "History of the Order of Elks". It is a book that will delight any member of the Order. It gives the complete history of the Elks from its earliest days and, what's more, gives it in a highly readable, interesting way. In it are 145 illustrations and the book is beautifully printed throughout.

Here in one book are many facts not generally known to many members. Your Elk friend or your lodge library will treasure this authentic record of Elk information. Send for it TODAY. Price \$3.50 plus 7 cents postage and insurance. You'll find it a splendid presentation piece; one that will be welcomed and cherished. For N.Y. City purchases add 3% sales tax. Address, THE ELKS MAGAZINE, 50 E. 42nd St., N. Y. 17, N. Y.

# Smoke for Pleasure without fear

Lightweight  
**Kirsten MARINER**  
with patented "Radiator" stem

**ORDER BY MAIL**  
Handsome, durable pipe with light smooth grain Algerian briar bowl.  
**\$7.50** postpaid

The modern, "socially acceptable" pipe.

Stop worrying about reports on smoking. Use the Kirsten pipe with patented Duralumin "radiator" stem. It's a new scientific approach to safe and clean smoking pleasure. The "radiator" condenses out harmful tobacco liquids. Only cool, dry smoke reaches your mouth.

**PROVE TO YOUR OWN SATISFACTION WITHOUT RISK**

Smoke your KIRSTEN for 10 days. If you don't enjoy a cleaner, cooler smoke, return pipe for full and prompt refund.

**WRITE FOR FREE 24-page CATALOG**—Illustrates a new scientific approach to smoking pleasure. Also Pipes, Cigarette Holders, Tobaccos, Pouches.

**Kirsten PIPE COMPANY, Inc.**  
Dept. M SEATTLE 7, WASH.

## TRANSFER LIQUIDS QUICKLY, EASILY Automatically

### NEW SELF-STARTING SIPHON-PUMP

Here's a safer, faster way to transfer liquids, without messing up the job. This new NEOPRENE SIPHON-PUMP safely handles many acids and corrosive liquids. No metal parts. Plastic valves are acid-resistant. No need to apply to mouth. Squeezing bulb starts fast pumping-action. Doctors, chemists, technicians use for laboratory work. Now widely used in homes and industry. You'll find 101 uses for it. Gets into hard-to-reach places. Just what is needed to empty aquariums, clogged sinks, drain traps, tanks, window-wells, boats, small flooded areas, transfer gas from car to power equipment, outboard motors, etc. Instantly ready for emergency use. Have it when you need it by ordering NEOPRENE SIPHON-PUMP now. Send cash, money order, check for postpaid delivery. C.O.D. postal charges extra. MONEY BACK GUARANTEE.

Over 5 ft. long

**\$3.00** ppd.

**MERIDIAN CO.**  
DEPT. T-31  
366 Madison Ave., New York 17

# MARILYN MONROE

LIFE SIZE PRINTS OR GREETING CARDS

ALSO GORGEOUS LILI ST. CYR  
Glamorous Anita Ekberg, Pat Hall, Joanne Arnold, Madeline Castle  
THINK OF IT! THEY'RE 5 FEET TALL IN FULL COLOR

Big as life and twice as natural! Eye-stopping ACTUAL FULL COLOR photos—5 FT. TALL, 2 1/2" wide. Sensational gift or party gag. Use 'em for den, playroom, bar! On doors, screens, as wallpaper! Terrific as greeting cards (Christmas, Birthday, Get Well, Thank You, New Years, Valentine, many others—detachable greetings won't spoil prints—specify, well sign and mail). \$2 each. Two for \$3.75. All six \$11. Postpaid, in plain wrap. Send cash, check, M.O. Money-back guarantee.

**LIFE-SIZE, Dept. EK11-5**  
216 Tremont St., Boston 16, Mass.





# "SUSIE" Jointed Knee—Saran Hair DOLL

WALK HER—WASH HER  
WITH 4 OUTFIT WASHABLE MIX-'N'-MATCH ENSEMBLE

Nationally Sold at \$12.95

Complete with Entire Dress Ensemble \$4.98

plus 50c shipping or C.O.D. plus postage

- She Kneels—She Bends Her Knees
- She Walks—Sits—Stands
- Turns Head As She Walks
- Long Washable Saran Braids
- She Cries—Sleeps—"Prays"
- Unbreakable Construction—Completely Washable
- Guaranteed Walking & Kneeling Mechanism

BIG—20" TALL

'SUSIE'—So Very Lifelike—is the most PLAYABLE walking doll you've ever seen. Your favorite "little mother" will spend fascinating hours DRESSING her in 4 completely different outfits: WASHING her; WALKING her; SITTING with her, and PRAYING with her. Because of Sue's new miracle knee joint, she SITS NATURALLY with her legs hanging down from the edge of the chair like a real person. 'SUSIE' assumes and will hold (no flopping) all lifelike body positions. Her Saran hair can be washed and combed; her pigtails braided and set in any fashion desired. She is beautifully formed, even to the small details of finger nails, dimples and creases in her chubby arms and legs. She is molded of the newest super-shock-proof plastic that assures years and years of loving play. "SUSIE" is Commended By Parents' Magazine and is Unconditionally Guaranteed.

"SUSIE" IS ALSO AVAILABLE IN THE LARGEST SIZE MADE—23" TALL—Has all above features. Nationally sold at \$15.95—OUR PRICE \$6.49 plus 50c shipping or C.O.D. plus postage.



She Sleeps  
Sits Naturally  
Unbreakable  
Wash Her Dress Her

P. J. HILL CO. Dept. H-775  
NEWARK 1, N. J.



**THE VERSE INITIALS SPELL YOUR OWN NAME**

We will write a warm, sincere verse with the initials spelling your own name, as "THE JOHN MASONS" is spelled downward by the verse pictured. There's room for up to 21 lines (besides those spelling "THE"). Your address (or, if you prefer, "Christmas 1955") is on cover. All in raised foam white on soft green antique finish paper. Folded to 4 1/4" x 5 1/2". White envelopes. 25—\$3.45; 50—\$5.95; 75—\$8.45; 100—\$10.95; 250—\$22.50. Each over 250—9c. Postpaid. Money-back guarantee!

*Yours Free!* Miles Kimball

148-page catalog of exciting gift ideas! 92 Bond St. - Oshkosh, Wis.

**IVES MEAT-LIFTERS** ... the perfect practical gift for the Gourmet!

For any occasion, give a pair of Ives Meat-Lifters. Your thoughtfulness for safety in handling large roasts, hams, steaks, and fowl the easy, convenient way, will be doubly appreciated. No spills—no painful burns—no loss of juices. Approximately 11" long; overall tine spread 6 1/2"; positive grip finger-fitting handles. Mailed in self-storage box.

Send check or money-order—sorry, no C.O.D.'s. Money-back guarantee. \$2.75 per pair plus 25c postage in U. S. A. IVES NEW PRODUCTS, Inc. 211 Medical Arts Building • Richmond, Indiana

**LIKE NEW!** .....  
Yes, your old or worn COMFORTERS will be made to look, feel and wear like new! Our exclusive recovery process sterilizes and revitalizes the filling. We stitch in beautiful designs on luxurious, serviceable fabrics. Delivery: ONE WEEK.  
ODD SIZES OUR SPECIALTY  
Free Samples on request. Write for Booklet EM

**STEWART Slumber Shop**  
528 MADISON AVE. NEW YORK 22, N. Y.

**SLEEK, SILKY CALFSKIN** makes a wonderful rug or wall hanging for a young Buckeroo's room or family game room. Comes in brown and white or black and white, is delightfully soft to the touch and doesn't show wear. 5 sq. ft. \$10.95; 6 to 7 sq. ft., \$14.95. Add 50c postage. \$2.00 extra for 3-initial brand. Brandicalf, Dept. Z-4, 157 Federal St., Boston 10, Mass.

# ELKS FAMILY SHOPPER

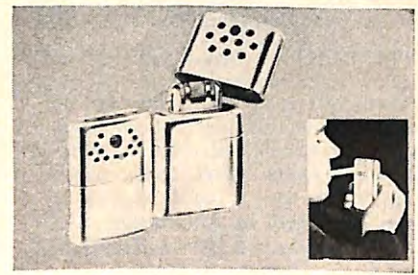

**NEW HAND WARMER** doubles as a cigarette lighter to make an ideal gift for an outdoor man. One filling (one ounce fluid) gives heat for 24 hours. You puff cigarettes alight through the hole in cover—no flame. Gleaming chrome plate, flannel carrying bag. Jon-E Warmer, \$2.95 ppd. Aladdin Laboratories, Inc., Dept. E, 620 S. 8th St., Minneapolis, Minn.



**FOR CHRISTMAS PAGEANTS** or just make-believe play, these lovely, light-as-a-breath Fairy Wings turn little girls into fairy princesses. The wings are of tarlatan, held in place by elastic. Assorted colors. Set includes fairy wand and treasure bag. Complete, \$1.25 ppd. Spencer Gifts, 561 Spencer Bldg., Dept. E, Atlantic City, N. J.



**SLEEK, SILKY CALFSKIN** makes a wonderful rug or wall hanging for a young Buckeroo's room or family game room. Comes in brown and white or black and white, is delightfully soft to the touch and doesn't show wear. 5 sq. ft. \$10.95; 6 to 7 sq. ft., \$14.95. Add 50c postage. \$2.00 extra for 3-initial brand. Brandicalf, Dept. Z-4, 157 Federal St., Boston 10, Mass.



# ELKS FAMILY SHOPPER

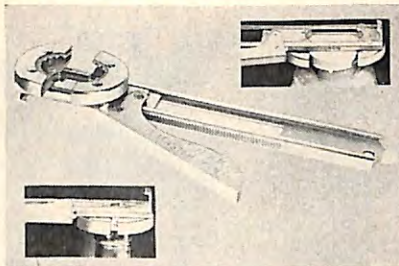

**FAMOUS GILHOLLIE**, master jar opener and resealer is indispensable in the well run kitchen and an ideal gift for holiday entertaining. It lifts all caps without distorting them, unscrews the tightest lids and recrimps soda bottle caps. Adjustable grippers fit all size bottles. Chrome-plated steel. \$2.95 ppd. Meridian Products, 366 Madison Ave., New York 17, N.Y.



**JINGLE TOE SLIPPERS.** Put these gay little foot warmers under a youngster's bed for his first surprise present Christmas morn. Bright red quilted cloth, white stocking tops, rubber soles, and tiny tinkling bells. Small, medium, large. \$2 per pair, 2 pairs, \$3.85 ppd. Red Oaks, Dept. E-12, Winnetka, Ill.

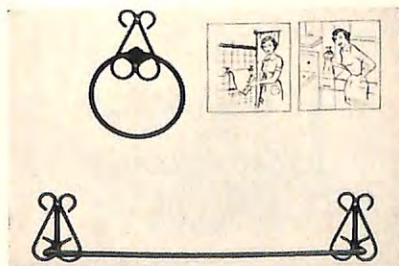

**TOWEL RINGS AND BARS.** These accessories of black wrought iron design add a decorator's touch to your home, are wonderful for giving that "new look" to kitchen and bathroom. Complete with screws for easy mounting. 12" towel bar, \$1.75; 18" bar, \$1.95; 4" ring, \$1.75, all ppd. Laurie & Co., Dept. EM, 507-5th Ave., New York 17, N. Y.



## ILLUMINATED SANTA AND REINDEER OUTDOOR DECORATION

Make way for Santa! Stake him and his 8 Reindeer into the ground in front of the house and bid welcome to all! 22 1/2" tall Santa in his sleigh, just loaded with gay packages; his 8 prancing Reindeer—Donder, Blitzen, Dancer and the rest . . . what a thrill for the Kiddies and you.

too! Of extra sturdy plastic in bright, weather-resistant colors, with anchoring stake. Complete with U.L. approved outdoor cords, bulbs and aluminum reflectors. **\$8.95**

**ELRON**

225 W. Erie St., Dept. 268  
Chicago 10, Ill.



## SNOW CRUST CHRISTMAS CUTOUTS

Now you can give a beautiful stained glass effect to your windows during the yuletide season. Can also be used on doors, mirrors, etc. Set contains: Santa, Snowflakes, Cane, Carolers, Bells, Stars, Stockings, etc. (44 pcs) Printed in gay season's colors. Easily applied! Moisten window, place on glass and it sticks! Only \$1.00 set ppd. Money back guarantee. **FREE!** Giant Santa Claus 22 inches high with double order. Money back guarantee.

Kesto Products, Box 49803, Los Angeles, California



## GIANT NURSERY RHYME WALL DECORATIONS

These delightful new nursery rhyme figures are ideal for any nursery or playroom. Printed in full, gay colors on heavy card stock, ready to hang. Figures are from 12 to 15 inches high. Use them on walls, closet doors, cribs, etc. Your choice of Hi Diddle Diddle or Jack and Jill. \$1.49 each group or \$2.98 ppd. (22 pcs) **FREE!** 8-page coloring book with double order. Make excellent gifts. Money back guarantee.

Kesto Products, Box 49803, Los Angeles, California



## BIG... BIG FIREHOUSE!

Large Enough to Drive Right In!  
2 Children Can Play In It

**\$1**  
COMPLETE

Most realistic Firehouse ever built. Fun and Excitement for Boys and Girls from 2 to 12. Over 23 cu. ft. inside, 9 sq. ft. of floor space, and almost 3 ft. tall, yet folds compactly. A GIANT Size replica of a small town Firehouse in full color, complete with Firebells, Axes, Ladder and Shiny New Fire Engine. The roof slopes down to Red Shingled walls, decorated windows. Constructed of 50 lb. Heavy Kraft for durability. Cutaway shows unique 1 pc. construction utilizing extended folding table legs supporting roof. No tools needed. Sets up in less than a minute. For immediate delivery, send cash, check, or money order for \$1.00. Add 25¢ shipping charge on each house ordered. **FREE!** 25 Games & Puzzles! Guaranteed. No C.O.D.'s.

**GIANT FIREHOUSE, 33-2nd Ave., Dept. F-1139, New York 3, N.Y.**

# 20 LARGE NEW TOWELS 5¢

Incredible, but true! 20 large-size, new towels in colors and white—for only 5¢ each! Minimum order 20 for \$1.00. (Please include 15¢ extra for postage and handling, or \$1.15 in all for 20 Towels.) Others charge \$1.00 for only FIVE unwoven cotton and rayon towels like these but we made a terrific purchase and are passing savings on to you. Limit 2 orders per customer. Money-back guarantee. Order TODAY! Make wonderful gifts.

**NICKEL TOWELS** Dept. 556, Box 881, St. Louis, Mo.

Nickel Towels, Dept. 556  
Box 881, St. Louis, Mo.

Please send me \_\_\_\_\_ pkgs. of  
Towels. I enclose \$\_\_\_\_\_

Name \_\_\_\_\_

Street \_\_\_\_\_

City \_\_\_\_\_

State \_\_\_\_\_



## CONSUMER REACTION SURVEY...

# 5 TEST SMOKE SAMPLE CIGARS

Before starting our new advertising campaign we want to find out which of these cigars will be the most popular. After you've Test Smoked these 5 completely different fine quality cigars for us, please check off your brand preference on the simple questionnaire enclosed. All mild, all large size 5 and 5 1/2 inches long, Havana Blend luxury cigars.

You can forget about the cost of these fine mild cigars, we've written them off . . . all we ask is that you please send 25¢ to help cover cost of postage, expense and cigar tax. Sorry, only one Sampler Kit per man. (Mail order only.)

**FILL IN COUPON AND MAIL TODAY—PLEASE PRINT LEGIBLY**

**WALLY FRANK LTD., 132 CHURCH ST., NEW YORK 7, N. Y.**

Dept. S319

NAME \_\_\_\_\_

ADDRESS \_\_\_\_\_

CITY & \_\_\_\_\_

STATE \_\_\_\_\_

ALL Enclosed find 25¢, send the 5 cigars described above, I'll check off the questionnaire after 5 to 5 1/2 in. long! Test Smoking.



Style #100 Write for Morton's NEW CATALOG OF 20TH ANNIVERSARY SPECIAL OFFERS! With Fur Tote-Bag Style #792

25 Styles ONE PRICE \$22.95

**NEW Cape Made From OLD Fur Coat \$22.95**

Now have that out-of-style, even old discarded fur coat remodeled into a lovely new cape with new lining, interlining, monogram, fur cleaned, glazed, all only \$22.95. Write for Morton's new brochure of exciting 20th Anniversary values, showing 25 new styles at \$22.95, many including fur hat, muff or fur tote-bag. Or order from styles pictured. Just mail us old coat, state dress size and height. Pay when completed new style arrives. Morton's work praised by editors of HARPERS BAZAAR, GLAMOUR, MADMOISELLE, REDBOOK, and many others. ACT NOW!

**MORTON'S**, Dept. 45-K, 312 Seventh Street, N.W. Washington 4, D. C.



**Wonderful gift . . . in pastel colors, Juliette® LADIES' ELECTRIC RAZOR \$3.95**

Wonderfully efficient for lovelier legs, smooth underarms with never a nick or irritation. Quick, powerful AC. Pink, blue or ivory, attractively gift boxed, including matching leatherette travel case. State color choice. Send check or M. O., \$3.95 ppd. Money-back guarantee. (Free-personality development gift catalog). Mrs. Fields Shopping Service, Dept. LK11, 237 Huguenot St., New Rochelle, N. Y.

**SUGAR BABIES**



Imported From Holland ONLY **69c** per box ppd.

Here's a real Dutch treat . . . for Christmas giving, for your own parties or the children's, for decorating cakes, for weddings, showers, parties or teas. A box of 20 gay and colorful Sugar Babies that look much too cute to eat . . . and taste much too delicious not to! They're fresh and made of the finest ingredients, with a luscious chocolate or almond crunch filling that must be tasted to be believed. Order a few boxes today.

Send Check or M. O. No C.O.D.'s Please Send For FREE Big Christmas Catalog of Gifts, Gadgets and Toys

**SPENCER GIFTS**

533 Spencer Bldg., Atlantic City, N. J.

**DOLL Furs**

**\$2.98** postpaid for complete set



A small girl will love you and this cunning set of real furs which comes in sizes for dolls from 7" to 18" tall. Think of the pride with which a moppet will dress her favorite "baby" if she owns the sheared white bunny coat, hat, and muff shown here. Lining is white satin!

For dolls 19" to 26"—cape, hat, and muff set—\$3.48 ppd.

Specify height of doll when ordering. Immediate delivery. Satisfaction guaranteed. Send check or money order. For Air Mail shipment, add 35c.

**Hobi** Dept. D-25, 15 West 57th St., N. Y. 19, N. Y.

**DAVY CROCKETT WALL CUTOUTS**

Ideal Christmas Gift!

Guaranteed to delight or Money Back



You and your child will thrill over these HAND-PRINTED wall decorations for nursery or play-room. The cutest Davy Crockett Tell-A-Story imaginable. New, attractive and lasting. Easily applied like wallpaper. In warm, gay colors, 7" to 14" tall.

COMPLETE SET OF 20 PIECES just **\$3.95** ppd.

**JO-ED ENTERPRISES** P.O. Box 69, Glendale, Calif., Dept. E-115



**TITANIA**

the Gem stone you read about in READER'S DIGEST

MORE BRILLIANT DIAMONDS More Beautiful than

Unset "Titania" gems, 1 to 5 carats, for your own rings, brooches, etc. Per Carat \$10\* ONLY



1 carat "Titania" Solitaire set in a beautiful 14 kt. gold mounting. Complete ONLY \$22.50\*

1 carat "Titania" set in a Masculine box style 14 kt. mounting. Complete ONLY \$28.50\*

Regent (Synth.) Star Rubies and Sapphires at proportionately low prices FREE booklet and handy Ring-Size Chart \*Plus 10% Federal tax



10 Day Money-Back Guarantee LAPIDARY CO.

Dept. E-118, 511 East 12 St., New York 9, N. Y.

**COLOR PRINTS From Your Color Films**

Fast Service—high quality KODACHROME, ANSCOCHROME EKTACHROME, ANSCO COLOR 4 x 5 | 5 x 7 | 8 x 10 50c | \$1 | \$2 FILM PROCESSED ANSCO EKTACHROME 51 DUPLICATE 35mm slides, 25c

**25c** 2 1/2 x 3 1/4

Satisfaction or Your Money Back Send for complete price list. AUTHORIZED ANSCO COLOR LABORATORY

Minimum order \$1 No COD's please

**COLORFAX LABORATORIES** 1160-A Bonifant St., Silver Spring, Maryland



FOR Your Favorite Elk

Here is an official Elks pin, approved by the Grand Lodge, specially designed for that member who has been an Elk for 30 years. As are other pins designating membership or years in the Order this pin enameled red, white and blue as shown is a truly handsome example of craftsmanship. Any Elk entitled by years of membership to wear it will be proud to display it. It is a life-long gift that will bring years of fond memory of the one who gives it. Three varieties—one #10 plain with no jewel—\$8.25. #10A Same design but set with one blue sapphire—\$9.90—Third pin #10B set with sparkling diamond \$19.00. All three 10kt gold with gold plated post and attaching button. Please order by number. Prices include Federal tax. For N. Y. City orders add 3% sales tax. Sent post paid including insurance. Allow two weeks for delivery. Order your gift pin TODAY from THE ELKS MAGAZINE, 50 E. 42nd St., N. Y. City 17, N. Y.

**ELKS FAMILY SHOPPER**



**ELECTRIC SOCKS.** No foolin', what could be better for keeping warm in the great outdoors come winter? All wool, with warming wires woven neatly into the toe, they operate on 2 standard 6 volt batteries carried in pocket. Ideal gift for skiers, hunters, skaters. Sizes 10, 11, 12 only \$12.95 ppd. (without batteries). Wayne Mfg. Co., Dept. E, Wayne, Pa.



**A CHEERING CUP** of tea is all the cozier served from this graceful little kettle. It has a removable strainer so you can use tea bags or loose tea. Black simulated raffia handle is smart against natural or brass colored aluminum (choice). Holds about 4 tea-cups. \$1.98 ea. or 2 for \$3.75 ppd. Downs & Co., Dept. E, Evanston, Ill.



**FOR YOUR CHRISTMAS CENTERPIECE . . .** this charming antique finish wrought iron candelabra, decorated with pine cones and needles. The greens are preserved to last indefinitely. Of course you can remove them and fill the container with fruit or flowers for year 'round use. 8 1/2" x 17", 10" red candles included. \$3.95 ppd. Clarion Products, Dept. E, Box 488, Highland Park, Ill.



# Bancroft's PRESENTS... TOMORROW'S GIFTS TODAY



**AND, AWAY WE GO...!**  
Rocket Shoes are the newest in fun for small fry! Safe and durable—perfectly balanced to give a hopping good time. Adjustable to fit all children from 6 to 12 perfectly. Sturdy caps in front to protect shins; ankle straps protect young ankles. With highest quality steel springs, rubber shock absorbers. Kangaroos look like they're walking.  
BG 4456. . . . . \$5.95



**THE BOOK THAT TALKS!**  
A voice is built into every page! As the child turns the pages, each different animal on every page talks in its own particular way. The cows moo, the dog barks, the sheep go b-a-a-a! Press the entire book and the whole farmyard sings out in chorus. Loads of funny fun with barnyard scenes in bright, gay colors.  
BG 1905. . . . . \$1.50



**PERFECT NAILS IN MINUTES!**  
Transform broken, split or bitten nails into long, graceful nails you've longed for! "Beauty-Nail's" glamorizing solution brushes on like nail polish—builds nails of uniform length. Not an artificial nail... but a scientific compound that ACTUALLY GROWS with your own nails. Files, polishes beautifully. Won't come off. Set of 2 nails.  
BG 7040. Complete. \$3.30



**Walk On Ice Without Falling!**  
Ice on the sidewalks? No! Don't worry! Just put on these "No-Slip" Foot Grippers and walk on ice or snow without fear. Helps avoid dangerous, painful falls. Hardened, rustproof steel teeth give firm footing on slickest ice. Slides over boots, shoes, or galoshes. Elastic band fits men's, women's, children's shoes—any size.  
BG 4713. Two pair. \$1.00



**Full Size Electric Fireplace**  
Looks like the real thing—logs (GLOW and FLICKER! Santa can visit your home in style and "warm" himself by your "fire." Realistic red colored bricks on heavy Vinyl Kraft-board and even a green Holly wreath. Simulated andirons and logs, electric cord, socket, bulb and flicker. Sets up in 90 seconds. Almost 4 ft. sq. overall.  
BG 4553 S. . . . . \$3.95



**Stately 4-Candle Centerpiece**  
Decorate your table with light and loveliness! Styled in modern, casual simplicity...hand-some centerpiece exquisitely displays flowers and fruit flanked by 4 stately candles. Artistically crafted of jet black wrought iron with delicate iron lace center bowl. Sheer delight for formal or informal dining. 7 1/2" x 18".  
BG 6298. . . . . \$2.95



**Santa Talks To Your Child**  
...and calls him by name! Imagine the thrill! Santa talks about being good, discusses his reindeer, etc. Watch Junior's eyes pop when Santa talks to him personally. See how excited he'll be as he joins in singing Jingle Bells with Santa and his helpers. Each individual recorded. Unbreakable. State child's name.  
BG 4698 D. . . . . \$1.00



**REAL SNOW SKATES**  
They're just like miniature skis! Swift Snow Skates provide winter fun and healthful exercise as young'uns skim over snow—no ice needed. Adjustable to any child's foot. They're made of steam-bent hardwood with grooved hot-rolls. Aluminum heel plates, sturdy ankle straps. Over 16' long and really trimmed in red.  
BG 3509. . . . . \$1.79



**Unbreakable Dozen Dollies**  
Your Young Miss will shriek with delight when she sees these darling dolls. Imported from Italy, each one different. 3" dolls have different colored hair, dress and hat. Hand-painted faces, movable legs and arms. Put them to sleep and their eyes close like real babies. Of course, they're cheaper by the dozen.  
BG 6615. Set of 12 \$2.95



**All-Steel Personal Check File**  
Banker's efficiency for cancelled checks! Monthly separators in attractive steel Check File permit quick reference and enables keeping important checks in place at all times. Keeps them safe, clean. Sliding follower makes filing, removal easy. Holds 5 year record to provide tax, budget or business data. Baked enamel finish.  
BG 4638. . . . . \$3.95



**Personalized Denture Dish**  
An orchid to the person who thought this one up! Spacious plastic container has other uses, too, but it's ideal for sparkling false teeth that need overnight parking. The lucky recipient will be so thrilled he'll want to put his teeth in at once. We'll handletter any name along with the letter words (as illustrated). So Sanitary.  
BG 1725P. . . . . \$1.25



**40-PIECE DINNERWARE RACK**  
Dishes say "Good-bye Mr. Chips" in this space-saving Dinnerware Rack. Now—any dish can be removed without "balancing the pile" or disturbing surrounding dishes. White Vinyl cushioning prevents chipping, breakage. Holds a complete set of dinnerware—8 each of cups, large plates, saucers, butter and fruit dishes. 17 3/4" x 9" x 10".  
BG 6514 S. . . . . \$3.49



**SKUNKY, THE STINKER DEODORIZER**  
Simply adorable! Even the boss smiled when he saw the cute attached poem that reads: "My name is Skunky, the stinker, and 'tis my job you see... to keep the bathroom pleasant for those that come after me... Just hang him on the wall—he quickly chases odors. Comes complete with odor-dispelling incense matches. Fashioned from glistering ceramic in "true-to-life" color. He's certain to become the family favorite."  
BG 3213. . . . . \$1.98  
Set of 6 extra packages of incense matches.  
BG 3734. . . . . 89c



**Personalized Half Cups**  
When they ask for "half-a-cup" of coffee—give it to them! Here are real, jumbo, full-size cups that are cut in half. They're made of highly glazed, hand-decorated ceramic with words as illustrated. We'll hand-letter 'em with ANY family or first name.  
BG 4969P. . . . . \$1.00  
BG 4970P, 4 for \$3.75

**HOW TO ORDER:**

- Order by number, stating quantity desired.
- Add only 15c to total of order for postage and handling.
- Send payment (check, money order or cash) with your order. No C.O.D.'s please.

Complete Satisfaction Guaranteed.  
**SEND ALL ORDERS TO:**  
**BANCROFT'S**  
1112 So. Wabash Ave., Dept. EL-543, Chicago 5, Illinois



**Magic Stump Remover**  
Don't dig!... Don't chop!... Don't blast! Don't let a tree stump hold up progress on your home or farm. Just pour in Magic Stump Remover and it eats open sap pores; quickly rots stump away. Once decomposed, removal is easy. Non-harmful to surrounding plants. For 1-2 stumps.  
BG 4489, 8 oz. \$1.50



**PERSONALIZED "MIDNIGHT COACH" SIGN**  
Your name and house number G-L-O-W in the dark! Charming Coach Sign adds friendly warmth to your house—helps guests find it, too. Imagine! Artistically hand-lettered with ANY family name and house number—and it can be seen DAY or NIGHT! An enchanting addition to lawn, house, mailbox, post or tree. Specially molded from heavy metal-methacrylate to resist wind, rain, snow and sleet. Rich black hammered crinkle finish. Stands 5 3/4" high, 15" long.  
BG 3664 P. . . . . \$1.00

## For Elks Who Travel

(Continued from page 19)

Caribbean circuit. Some stop directly at Montego Bay, Jamaica, in the height of that resort's social winter season. The Alcoa cruises which start out of New Orleans terminate, for reasons that escape me, but I'm sure are perfectly comprehensible to the people of Alabama, at Mobile. They begin at \$525 and take about 16 days. For anyone with heaps of time, and I would think, equal heaps of money, the "Del Sud" and the "Del Mar" warm up with a stop at St. Thomas and then zoom for Rio, Santos, Montevideo, Buenos Aires, and on the way home, Curacao.

The "Stella Polaris" will make one beat from New Orleans whence it departs on March 31st bound for sixty-eight days in the Mediterranean. Among its fanciful stops will be, after Havana and St. Thomas, Philippeville, the Isle of Rhodes, the fabulous Greek islands of Delos and Santorin, Nauplia in the Peloponnesus. It will course through the Corinth Canal, not to mention the Kotor fjord of Yugoslavia, touching at Dubrovnik, a delightful medieval city still preserved by the Yugoslavs. All it will relieve you of is \$1,490.

The "Independence" follows the trend to the Greek Islands too, but it will also

stop off on the way at the Canary Islands, Madeira and Egypt. The "Britannic" will spend 66 days touring North Africa, the Near East and the glamor ports of Italy, Spain, and France. You drop \$1,275 in the fare box for this cruise in luxury.

That brings me to the West Coast and in this regard I would like to point out that the "Lurline", that stand-by of the Matson people, sails from San Francisco December 21 and from Los Angeles the next day on a fourteen-day cruise to Honolulu and Hilo, returning to Los Angeles. The minimum fare is \$311.50, a price tag which includes your hotel ashore. Matson owns several along the fringes of Waikiki. Thereafter the "Lurline" departs more or less regularly every twelve days to Those Delightful Islands,

with the minimum roundtrip fare scaled at \$260.

American President Lines takes off every three weeks from San Francisco and two days later from L. A., bound not only for Hawaii, but also Yokohama, Manila, Hong Kong, and Kobe. The whole business takes 42 days and comes to \$1,147. It is a handsome trip and there are days to be sure, when you can swim in the outdoor pool. There will be days, too, when you will be grateful for that big floating American hotel that is so nice to come home to.

For those with dreams of Tahiti—does that leave anyone out?—there is an immense white schooner sailing out of Los Angeles every few months or so, making what even the most conservative creator of prose would have to call the trip of a lifetime. The schooner, named the "Te Vega" puts in first at Honolulu, then heads south to romance. It docks at Papeete harbor, Tahiti, for five or six days, then spends the next eleven cruising the Society Islands, which is to say, Bora Bora, Moorea, Tahiti Iti and like that. I won't go into the price as I would rather not spoil your interlude, but you have to admit it's a nice way of staying warm once the mercury congeals.





with Ed Faust



# In the Doghouse

There's a dog for almost every hunting purpose.

TO the enthusiastic huntsman there is no sport in all the world to equal hunting and no dogs so highly prized as well-broken field dogs. I know that among the more than a million men who are Elks there are thousands of hunters. I know this because about a year ago an Elks Magazine survey revealed that no less than 41.3% reported an active interest in the sport. The many letters I receive from readers lend further support to this fact. While the letters deal with one subject—a dog—as the hunting seasons approach more and more of them are concerned with gun dogs, their care and handling, although throughout the year I'm asked questions about the training of such dogs.

America has been blessed with a wide variety of feathered game such as pheasant, quail, grouse, snipe, woodcock, duck, coot, goose and teal while rabbit and 'coon are the principal furred critters that call for the employment of dogs. Fortunately, too, there's a wide variety of hunting dogs, among which there's at least one breed acceptable to the most captious critic among huntsmen. Of course, I'm referring to the pure breeds among the dogs, although it has been known that dogs of mixed breeding sometimes do take the field in ways that are frequently effective. But the pure bred is more often the choice of the experienced gunner, as such dogs are descendants of generations of ancestors that have been trained for hunting. While nearly all dogs are natural hunters there are a few—and they'll be found in almost every breed—in whom the instinct to hunt is so dormant as to be nearly non-existent. Such, however, are rare. Now the dog, no matter how proficient as a natural hunter, has to be trained to cooperate in hunting with man. That's just what training does for the hunting dog; it teaches him to cooperate with the huntsman. Without such training the dog would be more likely to become a hindrance than a help.

Perhaps the most popular among the breeds actually used for hunting are the setters. True, some of the spaniels are more favored among the general public because, being smaller dogs, they more readily fit in as house pets. Also, for

hunting use they are not as powerful as the setters and other larger hunting breeds, which is important when the game is located in country covered by heavy brush making it difficult for the smaller spaniel to break through. The pointers and retrievers are other reliable breeds for field work, with a comparative newcomer from Germany, the weimaraner, rounding out the list for what is designated as group 1 "Sporting Dogs" by the American Kennel Club, the organization which governs the formal activities of pure bred dogs and keeps the stud books without which a dog's pedigree would not be verifiable. However, among this group as well as the dogs in "Group 2", another division of sporting dogs which includes all the hounds, not all that are registered are actually used in the field, many being kept as show or bench dogs or simply for pet purposes. The American Kennel Club, or A.K.C. as it is known among the cognoscenti, not only verifies pedigrees but licenses dog shows, obedience tests and field trials. In 1954 no less than 51,308 dogs competed in field trials.

Field trials are events wherein dogs compete with each other under actual hunting conditions. Dogs are judged by performance and awarded ribbons and other prizes. There has long been a difference of opinion between exhibitors of sporting dogs for bench shows only and those who breed them for the hunting field. The latter have claimed that the bench show dogs being bred largely for appearance are too finely formed for field work and are not rugged enough. Also, there are those who'll tell you that the bench show dog is a witless fellow who is related in name only to the more sturdy gun trained field worker. Many breeders of sporting show dogs have indignantly denied this. However, there's a tendency for both camps to get together, to try to produce dogs that, while being excellent examples of conformation to a breed standard, will also be stronger and more proficient for actual hunting.

Among the forty breeds that comprise Groups 1 and 2 of the sporting dogs there's such variety that it would be  
(Continued on page 55)

ILLUSTRATED BY CHARLES LIEDL

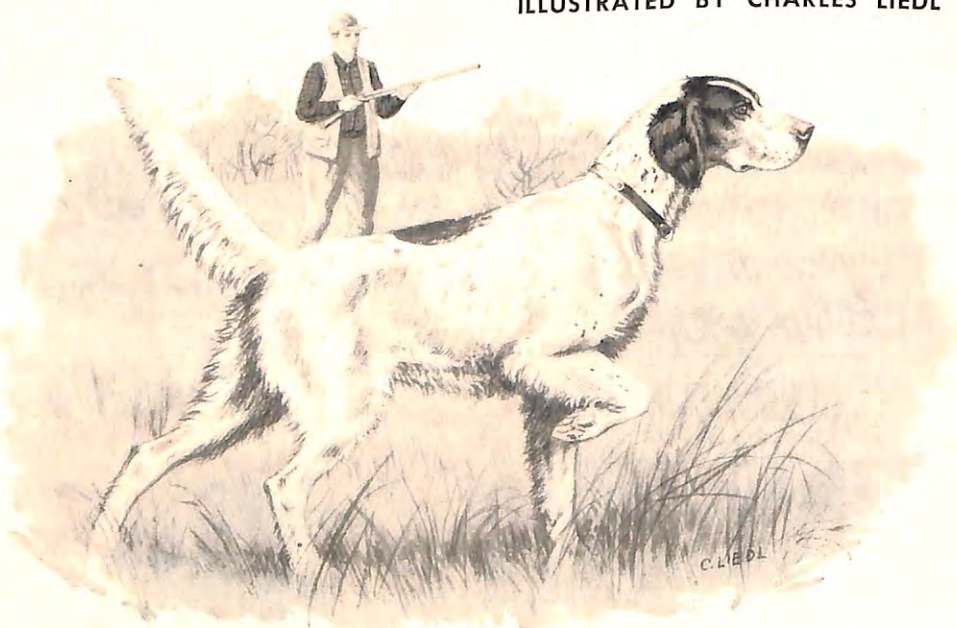

The English setter is a sporting dog of grace and beauty.



# NEWS of the LODGES



Not only did many lodges of the Northeast come to the aid of the flood victims in that area, the wives of members of Sturgis, Mich., Elksdom assisted, too, when they collected, sorted, boxed and shipped 54 packages of clothing to Waterbury, Conn. Left to right are Mrs. Frank Martin, Mrs. Robert Brumbaugh, Mrs. Fred Rahn and Mrs. Kenneth Tricker. The 1,600 pounds of clothes which were donated were shipped by the Kirsch Co. in boxes supplied by Sturgis Cartons, Inc.



In its first participation in the Iowa Elks Tournament, the Iowa Falls Bowling Team won first place on a score of 3,147, a new high for that competition. Left to right: Capt. P.E.R. L. G. Apland, Vern Stevens, Norman Christensen, Robert Peglow and Orrin Shelton.



Above: Two years ago, when the Bellevue, Ohio, Recreation Dept. formed an Old Timers Softball League, the local Elks participated. The following year, the lodge organized an Elks Old Timers Traveling Softball League which was repeated in 1955 with Norwalk, Sandusky, Galion and Bellevue Lodges taking part. Galion won the League title, with Bellevue in second place. Later the players and their wives were entertained at a dinner when trophies were awarded. Pictured were, left to right, seated: Rocky Larizza of Sandusky; League Pres. Pete Benninghoff and Team Mgr. George Zeigler of Bellevue, and Norwalk's Team Mgr. Harley Peters; standing: Norwalk Mgr. Red Edwards, Galion Asst. Mgr. R. W. Heiby, Mgr. Paul Klehm and E. R. Dale Mulvaney, and Bellevue Asst. Mgr. Jen Brickhart.



Above: This is Birmingham, Ala., Lodge's All-City Youth Band, conducted by Elk Tom P. Connors and selected from the county's top high school and college musical groups. Tag-named the Little Rebels, the group has appeared at many Elks functions, and was chosen to play the first concert at Birmingham's new zoo. Last year they were sent to Washington to represent Alabama at the American Legion National Convention. Of the band's membership, 27 of the boys and girls are medal winners in State competitions, with two of the boys members of the Birmingham Symphony. In the rear are Youth Activities Committee Chairman T. D. Stephens, P.E.R., E.R. Mauro J. Nappi and Ed Horton, Trustees Chairman.



Throughout the summer, Saginaw, Mich., Lodge put on weekly dancing parties for teen-agers of the community. With the cooperation of Station WSAM-TV, the Disc Jockey Dances were televised from the lodge home. The first event attracted 104 young people, and in the final weeks 445 were in attendance at each of these affairs, chaperoned by Elks and their wives.



Right: As always, the Elks were one of the first organizations to come through with tangible aid for the victims of the Northeastern flood area. Weehawken, N. J., Lodge, for instance, collected 70 large cartons of clothing, in addition to many canned foods and cash donations which E.R. James A. Sarubbi personally directed to the East Stroudsburg area. At the extreme right is his father, John Sarubbi, a lodge Trustee, with Trustees Chairman John F. Cahir on his right, Chaplain George W. Safer and three of the Elk-sponsored Explorer Scouts.



Left: E. C. Moriarty, second from right, was honored by Wichita, Kans., Elkdom recently in recognition of his 50-year membership during which he has served through all Chair Offices, as well as Trusteeship and committee participation. Left to right are E.R. Glen M. Atkins, 53-year member R. S. Duffield, originally a member of Mason City, Ia., Lodge, Secy. Willis B. Ward, P.E.R. Moriarty and Est. Lead. Knight Robert Obley. Another 50-year Wichita Elk honored *in absentia* was B. C. Steen, initiated into Cleveland, Ohio, Lodge 57 years ago.

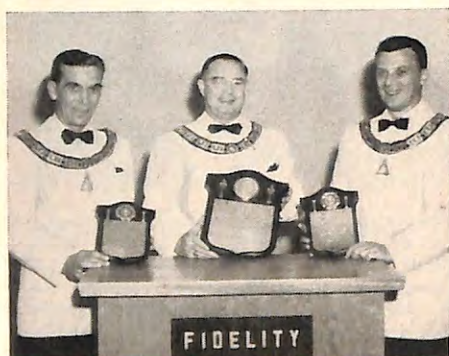

Above: In existence only a short time, South Miami, Fla., Lodge was honored recently for a great accomplishment—making the highest membership increase for its State in 1955. The award, given simultaneously with another tribute for its repeating a 1954 achievement by making the highest membership increase percentage, was presented by State Vice-Pres. Earl R. Adams. Left to right are P.E.R. A. J. Rebozo, founder of the lodge, E.R. D. D. Woodburn and P.E.R. Harry W. Prebish. At another ceremony, retiring D.D. John Rosasco presented the Gold Star Award indicating the lodge's successful completion of Past Grand Exalted Ruler Jernick's 16-point program.



Norwich Elks who hold the New York Ritualistic title, left to right: Inner Guard, Arthur Dietrich; Esq., H. G. Bush; Est. Lead. Knight, W. C. Masterson; E.R., W. D. Welch; Loyal Knight, D. O. Shetron; Lect. Knight, A. W. Gould; Chaplain, R. D. McNeil; Secy., L. A. Gorman.

### Brenham, Tex., Elks Pass Half-Century Mark

More than 600 Elks and their ladies were on hand to help Brenham Lodge No. 979 celebrate its 50th Anniversary in September when 13 candidates were initiated by the State's second-place Ritualistic Team from Galveston. Among the candidates were M. H. Ehlert and his two sons. Later a barbecue was served under the supervision of 14-year Mayor Reese B. Lockett, Treasurer of the Texas Elks Association.

Principal speakers were P.D.D. Wm.

S. Traill, D.D. Gerald M. Brassard, and Assn. Pres. E. C. Bunch and Vice-Pres. E. F. Burgdorf. Past Pres. H. S. Rubenstein. State Secy., served as Master of Ceremonies.

Highlight of the occasion was the presentation of 50-year membership pins to the lodge's 40-year Secy. F. L. Amsler, P.E.R., 32-year Tiler Sam J. Muery and Charter Members August Brockschmidt and Capt. Edward Becker.

E.R. Joseph Picone welcomed the hundreds of visitors, among them Past Presidents F. W. Beckstead, Raymond L. Wright and Victor E. Ferchill.



Chairman James A. Bresnahan of the Mass. Elks Assn. Flood Relief Committee, left, accepts a \$1,000 check from E.R. Frank E. Crawford of Leominster Lodge, as State Association Trustee George H. Mackie looks on.

Right: Elks Assn. Secy. R. Edward Dove, left, pictured with E.R. Lee S. Ogilvie, seventh from left, and other Elk officials, when ground was broken for the new home of Essex, Md., Lodge. The building will be so constructed as to make it possible to add to it without disturbing any part of the original structure.





## LODGE NOTES

Presentation of lapel pins, marking 25- to 45-year and Life Memberships, followed a dinner celebrating the 1,000th meeting of Rockland, Me., Lodge. Among those honored were Charter Member B. B. Smith, 45-year Elk Raymond Thurston and Life Members F. C. Black, P.E.R. E. W. Pike and Secy. Joshua N. Southard.

When former Grand Treas. John F. Burke observed his 80th birthday not long ago, his daughter, Mrs. Marie McClure, arranged a surprise party for him, attended by 150 relatives and members of the Order, including Past Grand Exalted Rulers John F. Malley and E. Mark Sullivan, and John E. Fenton of the Grand Lodge Committee on Judiciary. Mr. Burke, a P.E.R. of Boston, Mass., Lodge is a P.D.D., Past State Pres. and former Chairman of the Grand Lodge State Associations Committee.

Within a very brief period, Cheryvale, Kans., Lodge lost three of its most devoted members—P.E.R. Alva M. Hall, Claude C. Bush who had served as lodge Secy. for more than 20 years, and 50-year Elk P.E.R. J. L. Strickler, the lodge's last Charter Member.

Hermiston, Ore., Lodge's kick-off on Grand Exalted Ruler Walker's Youth Service program was its entry of a handsome purple and white float in two parades. Carrying a pair of high school seniors and towed by a convertible bearing four students wearing the Elks' colors, its theme was service to our young people, emphasizing Scholarship, Leadership, Visual Aid and Student Loans. Designed and built by the Elks and their wives, the float won top honors in the fraternal section of the "Dress-Up Parade" opening the annual Pendleton Round-Up, and second prize in that section in the Umatilla County Fair Pageant.

Among the volunteers who assisted the Muscular Dystrophy Assn. to raise funds through an all-night telethon was a delegation of New Rochelle, N. Y., Elks headed by E.R. Frank Moroze. Topping off their participation in the 19-hour, all-night telecast from the Westchester County Center, the Elks made a contribution to the MDA in memory of a late lodge member, Philip Grabel.

Wichita, Kans., Elk P.E.R. Wallace Hutchinson and his Veterans Service Committee threw their annual watermelon feed for patients at the VA Hospital in August. This party saw 666 pounds of melon served, and a nice selection of prizes awarded.

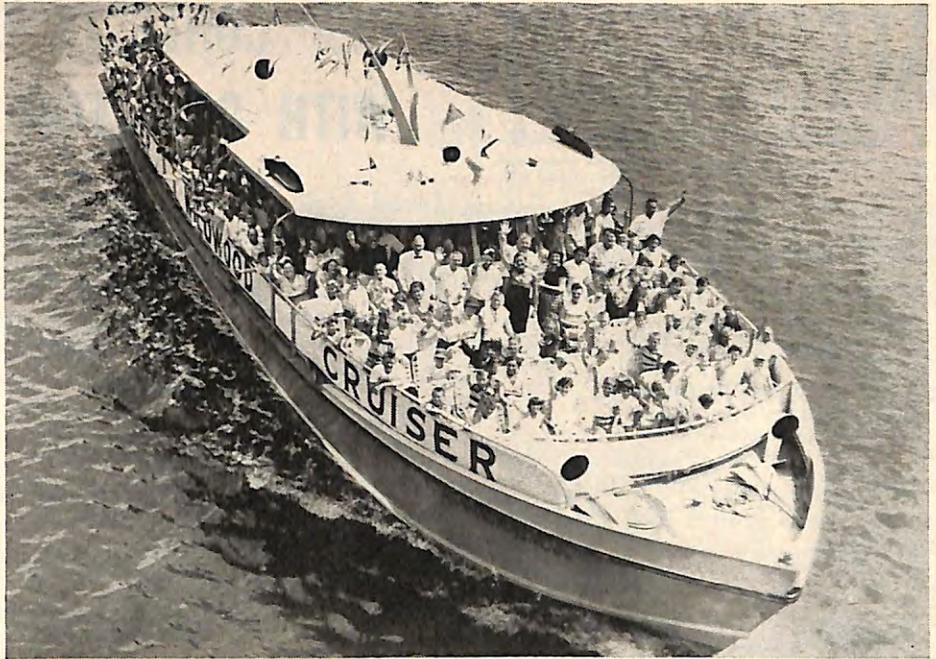

Every year the Elks of Millville and Wildwood, N. J., cooperate in entertaining underprivileged youngsters on a boat trip. This photograph commemorates the 1955 affair when 299 children enjoyed the trip, a full-course dinner at the club owned by Wildwood Lodge's P.E.R. Walter P. Kennedy during which they were entertained by such luminaries as television, movie and radio star Johnny Ray, and a two-hour swim in the pool following "rides" at the amusement park.



Nogales Elksdom is proud of these officials who took the Arizona State Ritualistic Title.



Officers and members of Juneau, Alaska, Lodge welcome M. E. Monagle, the Order's new Grand Tiler, on his homecoming following the Grand Lodge Convention. In the foreground, center, shaking hands across Mrs. Monagle, are the Grand Tiler, left, and E.R. Robert O. Faulkner.



# ACCOUNTANT

BECOME AN EXPERT

## .. BOOKKEEPER .. C.P.A.

The demand for skilled accountants—men and women who really know their business—is increasing. National and state legislation is requiring of business much more in the way of Auditing, Cost Accounting, Business Law, Organization, Management, Finance. Men who prove their qualifications in this important field are promoted to responsible executive positions.

Knowledge of bookkeeping unnecessary. We train you from ground up, or according to your individual needs. Low cost; easy terms.

Send for Free Sample Lesson and 48-page book describing the LaSalle accountancy training and the opportunities in this highly profitable field. MAIL COUPON TODAY.

### LASALLE EXTENSION UNIVERSITY

A CORRESPONDENCE INSTITUTION

417 S. Dearborn Street

Dept. 11328HR Chicago 5, Ill.

Please send me Free Sample Lesson and "Accountancy, the Profession that Pays"—without obligation.

- Higher Accountancy
- C.P.A. Coaching
- Bookkeeping
- Law: LL.B. Degree
- Business Management
- Salesmanship
- Traffic Management
- Foremanship
- Industrial Management (Machine Shorthand)
- Stenotypy

Name..... Age.....  
Address.....  
City, Zone, State.....



## New Catalog of 3000 Novelties

Special Wholesale Quantity Prices  
Wholesale Catalog 10c. Novelties, gifts, fun-makers, tricks, party goods, hobbies, live animals, model kits, magic, tricks, jokes, seeds, gadgets, cameras, optical goods, toys, movies, jewelry, disguises, puzzles, radios, auto & bike items, printing sets, motors, knives, books, sports, guns, music, games, science supplies, fireworks, office & household items, etc.  
JOHNSON SMITH CO., Dept. 173, Detroit 7, Mich.

## STAMP COLLECTORS

Big imported collection of 314 all different foreign stamps including Monaco Jules Verne Science-Fiction Set showing balloon & elephant, steamer & Atlantic Platform, giant tank, Argentina Flying Horse, Bolivian Revolution set, National Anthem. Italy AMG set PLUS hundreds of fascinating stamps of the world. This collection, cataloging over \$7.00, is yours for only 25c to introduce our bargain approvals. BONUS: 48 Page Stamp Dictionary included free.  
Stamper Co., 116-HE Nassau St., New York 38, N. Y.

## Exclusive tailoring process CONVERTS OUTDATED DOUBLE BREASTED SUITS INTO SMART NEW SINGLE BREASTED MODELS

Write Dept F for FREE BROCHURE and detailed information on how we can perform this AMAZING TAILORING MIRACLE  
Copyright 1954 By Sid Colburn BY MAIL!  
**Sid Colburn**  
313 NO. BEVERLY DRIVE BEVERLY HILLS, CALIF.

## 60 POWER TELESCOPE \$3.98

VARIABLE EYEPIECE 20X-40X-60X—BRASS BOUND  
NEW! Three telescopes in one, 3 different magnifications, 20 power for ultra-bright images with 40 and 60 power for extra long range. Guaranteed to bring distant objects, people, sports events, ships, moon, stars, etc. 60 times as close.  
Most powerful for anywhere near the money. 3 sections. Closes to 1 ft. long. Contains 4 ground and polished lenses. Also used as a powerful compound microscope. Directions included. Mass production enables us to offer this instrument at amazing price of \$3.98 complete. MONEY BACK GUARANTEE. We pay postage. Get yours now.  
CRITERION CO. Dept. EMB 21 331 Church St. Hartford 1, Conn.

# GER CONTESTS GET UNDER WAY WITH CALL FOR LODGE REPORTS

Grand Exalted Ruler Walker's Membership Control Program moved in high gear when he asked every Lodge to submit to the Grand Secretary a complete report on its membership and delinquencies as of September 30, 1955.

In a letter to Exalted Rulers, the Grand Exalted Ruler asked them to report on the number of members initiated from April to October, the number reinstated and the number dropped for non-payment of dues in the same period, and the number of members delinquent six months since March 31, 1955, a year since September 30, 1954, and the number delinquent for over a year.

At the same time, each Lodge was notified of the number of debit points with which it entered the Grand Exalted Ruler's Dues Delinquency and Lapsation Improvement Contest, which ends March 31, 1956. The debits are based on the number of delinquents on each Lodge's record as of March 31, 1955. Object of the Contest is to improve on that record by collecting outstanding dues and by reinstating members who have lapsed.

To make the Contest fair, Lodges with similar records are pitted against one another.

This Contest will, of course, have an important bearing on the results of the Net Gain in Membership Contest, which rounds out the Membership Control Program. Lodges are competing for the highest net gain, with the goal for the Order set at a 5 per cent increase, and a substantial reduction in the number of members dropped for non-payment of dues will make an important contribution towards that goal.

## Sanders of UCLA

(Continued from page 17)

was the most famous and sought-after prep star in California, a youngster whose football future was complicated by a hovering and doting father, Harvey Knox.

The youth enrolled at University of California in 1953, later quit, according to his dad, because the offense wasn't altered to suit the boy's style of play. Ronnie transferred to UCLA. To date there have been no rhubarbs. Sanders expects none. Father Knox remains in the background and probably will as long as Ronnie does well. The youngster tossed three touchdown passes in his first game and performed capably on defense.

Knox, in Sanders' calculations, is just one of the boys, or as he calls them, "the horses." Red is extremely reluctant to launch into a long-winded dissertation on techniques, strategy or psychology.

"The boys do the playing, not the coach," he says, succinctly. "Give me material. The difference between winning and losing is having the horses."

Hundreds of coaches abandoned the time-tested single wing offense for the T-formation in the 1940's and moved on to the predominant Split-T offense in the 1950's. Not Sanders. He has never coached anything but the single wing with a balanced line.

"Some call the single wing a horse and buggy offense," he says. "Maybe it is, but I like to think that we have a TV set on the dashboard."

"The basic stuff in our offense came from the University of Tennessee. (Three of his assistants played at Tennessee.) It's my opinion that Tennessee's fake-pass-and-run and the fake-run-and-pass are still extremely difficult to defend against. I know we've gotten a lot of mileage out of them.

"I picked up a few other things here and there," he adds modestly, but none of these technical items tells the story. Red oversimplifies the explanation of his success when he attributes all to material. Just as important, he knows how to create the vital intangible, morale; how to inspire boys, and how to teach the equally vital fundamentals, blocking and tackling. To Sanders football is almost that simple; he leaves the fancy football to others. His 1954 gang limited 10 opponents to a mere 41 points, blanking Stanford and Southern California, holding Maryland and California to a single touchdown.

Football can be pretty serious business on the UCLA practice field, but Red leaves the game there when he goes home. His tastes run to good books (mostly biography), Dixieland jazz music, or contriving a laugh at somebody's expense. Last winter Red lost a valued aide, Tommy Prothro, who took the head coaching job at Oregon State. Red tossed a farewell party for him. Knowing that Prothro had offered an assistant's job to



Clayton Stapleton, then at Wyoming, Red rigged up a phony long distance call. The party was in high gear when Prothro was called to the phone. The caller was the "president" of Wyoming, who proceeded to castigate Prothro for tampering with one of his employes—great fun for everybody but the unsuspecting Prothro.

In this respect, Red hasn't changed much since his student days at Vanderbilt. Then, as now, his main concern was sports. The family—his dad was a traveling salesman—moved from Asheville, N. C., to Nashville when he was an infant. He grew up there, starting his football education as an under-sized urchin of 10 or 11 on the sandlots. He blossomed as a heady quarterback at Riverside Military Academy in Georgia, then enrolled at Vanderbilt in his own backyard in 1923. Unfortunately, the cards of football stardom were stacked against him. He was too small—5-8 and weighing 143—and the incumbent field general was Bill Spears, a notable triple-threater of that day. Sanders, however, lettered every year, also earned one letter in basketball and three in baseball. He captained the baseball varsity and later played as a minor league infielder for three years.

**A**S A COLLEGIAN Red heard many an impassioned dressing room oration by his old coach, Dan McGugin, who was famous for his psychological twists. Today's college boy, Red says, has outgrown that sort of thing.

"I'm afraid the players would laugh at me," he added. "The better players don't have to be keyed up and there are so many good ones that none of them can afford to let up. Quite often, you find yourself trying to relax the squad before a tough game."

One year UCLA was about ready to take the field for an important battle with Stanford. The room was quiet, the air explosive, the players expecting a few last-minute words of wisdom from the coach. Sanders noted the assistant coach next to him was wearing a new suit. Red looked closely at the material and said for all to hear, "I don't care what anybody says, you keep on wearing it. Don't pay any attention to them. That suit looks all right." The assistant blushed, the players forgot the game for a few seconds and then went out and walloped Stanford.

Another time the UCLA squad was aboard plane en route to a tough road game. While the motors idled on the runway, Coach Sanders stood up in the aisle, looked at a piece of paper in his hand and said, "I've just been given the weather forecast for the trip; it says, 'Partly cloudy and scattered Bruins.'"

Sanders scoffs at the psychological gimmicks, certainly the obvious ones. But he has been known to make a sly play on the emotions. At Vanderbilt, his 1948 team had whipped Maryland, Yale, Ken-

## a new friend of Lord Calvert



MR. B. E. BENSINGER, President of The Brunswick-Balke-Collender Company, Chicago, Illinois.



PERFECTION? It's as near as your neighborhood liquor store or bar! Ask there for Lord Calvert . . . discover the flawless *flavor* and pleasing *lightness* that are making so many new friends for this famous brand. You'll learn, too, why Lord Calvert is known the world over as the sincerest compliment a gracious host can pay to friend or guest. If you've a taste for great whiskey—or a talent for serving it—order Lord Calvert today.

*The Whiskey of Distinction*  
*For Men of Distinction*

CALVERT DIST. CO., N. Y. C. BLENDED WHISKEY. 86.8 PROOF. 65% GRAIN NEUTRAL SPIRITS.



## Get this double-value TRAIN BOOK OFFER!

192-page, illustrated book on *How to Build and Operate a Model Railroad*.

New 44-page catalog of American Flyer trains and accessories in full color.

A world of railroad fact. Loads of action photos.

See the complete, famous-for-realism American Flyer line. *Only* scale model trains that run on 2-rail track, have puffing smoke, choo-choo, Pull-Mor power.



**BOTH ONLY 25¢—SEND TODAY**  
(or the catalog shown, 10¢)

Gilbert Hall of Science, Dept. 43  
Erector Square, New Haven 6, Conn.

I enclose 25¢. Rush both big train books.  
 I enclose 10¢. Send catalog only.

Name.....

Street.....

City..... Zone..... State.....

Offer good only in U.S.A.

### LEARN TO THROW THE BOOMERANG

A Fascinating Sport  
and Unique Gift

SEND FOR  
YOURS  
TODAY

Flight Tested—Guaranteed to Return  
Golden Red, Jade Green or Natural  
with Story and Instructions \$2.00 ea.  
**CARVED by Postpaid**  
**COL. JOHN M. GERRISH**



4105-K S. W. Parkview Ave., Portland, Oregon

## BRAND NEW XMAS GIFT

for Children . . . only \$1.00



Here is the most wonderful Xmas gift of all—and SO inexpensive! Send us your favorite snapshot, print or negative, of your child, family, pet, etc. We will enlarge it and make a large 8" x 10" life-like JIGSAW PUZZLE so natural, so touchingly personal, it will thrill the heart and capture the imagination of any youngster. Your choice of beautiful black and white JIGSAWS for only \$1.00 or gorgeous hand-colored only \$1.50! Send money or order C.O.D. Your picture returned immediately with puzzle. Money-back guarantee. SPECIAL! Photo Xmas Cards, your name printed FREE on each—25 for \$1.00, 50 for \$1.75, with envelopes. Postpaid. From negative or picture. Order TODAY.

75 for \$2.50, with envelopes. Postpaid. From negative or picture. Order TODAY.

AMERICAN STUDIOS, Dept. 203, LaCrosse, Wis.

**DRIVE ANYWHERE**

**DINSMORE AUTO COMPASS**

with CONFIDENCE!

These modern, fully jeweled compasses show you the right way—the short cuts. Save time and money! Surpasses rigid auto makers' tests. Send for

Free Folder—"Pants-Knives and Compasses."

**DINSMORE INSTRUMENT CO.**

1812-41 KELSO ST., FLINT 1, MICHIGAN



TRAVELITE \$5.95 (ILLUMINATED)

GUIDEWAY \$4.95 (NON-ILLUMINATED)

**HUNDREDS OF IDEAS**

for **BRONZE PLAQUES**

FREE illustrated brochure shows hundreds of original ideas for reasonably priced solid bronze plaques—nameplates, awards, testimonials, honor rolls, memorials, markers.

Write For FREE BROCHURE A For trophy, medal, cup ideas ask for Brochure B.

**INTERNATIONAL BRONZE TABLET CO., INC.**

Dept. 40—150 West 22 St., New York 11



Bruno Shaw, Elks Magazine writer on foreign affairs, this year again received a Freedom's Foundation award for an article which ran in the Magazine. The National Awards Jury selected his article on "Soviet Non-aggression Pacts." Dr. Kenneth D. Wells, President of Freedom's Foundation, presented the bronze medallion at Federal Hall Museum, New York, on September 16th.

tucky in a seven-game victory string. The team was tense and serious going into the traditional battle with Tennessee, which had not lost to Vandy in 11 years. Sanders wanted this one badly, but he didn't say so.

"Boys, you've already shown me what a great team you are," he said. "How you play today doesn't change the fact that you've done a good job this season. You don't need to show me a thing. I'm proud of you."

The Commodores exuded confidence from the first kickoff. The subsequent 28-6 victory climaxed Sanders' coaching career at his alma mater and set the stage for his departure for the challenging job on the West Coast.

Coach Prothro, who spent nine years on Sanders' staff, appraises his ex-boss as the best at "sizing up the football material—he seems to know how good a boy can be; he expects that very best, no more."

Only Sanders, for instance, could see the potential in 158-pound Lee Nalley. Red gave the youngster a scholarship at Vanderbilt in 1947. A year later, as a punt-return specialist in platoon football, Nalley led the nation with runbacks totalling 791 yards, a record that still stands. He repeated as the punt return champion in 1949 after Sanders had gone to UCLA.

Just last Spring Red faced a half dozen major problems in rebuilding a line riddled by graduation. The master stroke was the shifting of Don Shinnick, 210-pound fullback, to guard. By mid-season Shinnick was expected to be one of the finest collegiate guards on the West Coast.

Red developed this knack long before he became a "name" coach. You learn to

improvise as you climb the coaching ladder, except that Sanders apparently learned unusually well. Red assisted Josh Cody at Clemson after graduating from Vanderbilt in 1927, but, at that time, was torn between football and baseball. Three years in the minors helped to turn Red permanently to football. He coached Columbia, Tenn., Military Academy, 1931-33; and Riverside, Military Academy, Gainesville, Ga., 1934-37, compiling a remarkable 55-4-2 record for those seven years.

Red moved on to University of Florida as freshman coach in 1938, to Louisiana State as line coach in 1939, then back to Vanderbilt in 1940, beginning a six-year hitch, interrupted by two and a half years in the Navy, 1944-46. Old Navy friends recall that Red had a wonderful time garbling Navy phrases, showing an especial talent for it within earshot of the Navy brass.

Ted Williams played on Sanders' 1945 Pensacola Navy baseball team. Telling a pompous superior of victory in a recent game, Red explained, "Williams hit one over the centerfield bulkhead." Sanders, once seeing an old coaching friend arriving, gave him a deadpan and frosty, "Welcome aboard, sir."

No one is safe when Sanders joins a conversational group. He is happiest when offering a solemn-faced rib, or stinging someone in a sensitive spot. The obviously stupid question is one of his favorite techniques. Among staunch Notre Dame supporters, he is likely to say, "Do you think Knute Rockne could win today?"

Tom Meany, well-known sports authority, tells of the time Red, meeting Oscar Vitt, then a big league manager, for the first time, asked, "Wasn't Joe Jackson



over-rated as a hitter?" When Vitt grabbed an umbrella Red didn't know whether to run or be ready to defend himself. Using the umbrella as a bat, Vitt discoursed at length, with gestures, on the virtuosity of the baseball immortal.

Those who know Red best are as enchanted with his solid common sense as with this impish sense of humor. Wilbur Johns, the athletic director, was certain he wanted Sanders at UCLA after one day with him. That was January, 1949, and there's quite a story behind that one, too. Johns went to the American Football Coaches Association convention in San Francisco to shop for a successor to Bert La Brucherie. Sanders was one of six prospects on Johns' list, having been recommended by the late Grantland Rice, himself a Vanderbilt alumnus; Red Blaik of Army and Fritz Crisler of Michigan.

Sanders was headed for San Francisco, too, but the trains out of Chicago were snowbound. Red checked the airlines, accepting a spot on the waiting lists for the time being. Hours later he was preparing to return to Nashville when United Air Lines called to say he was booked out on the next flight.

"I didn't know Sanders at all," athletic director Johns recalled. "He moved to the top of my list after I had spent several hours with him."

**I**N LESS THAN TWO WEEKS Sanders was the new UCLA coach. Belatedly, Vanderbilt offered Sanders a long-term contract with retirement privileges of the academic staff, but the gesture came too late. Sanders was in no mood to reconsider even if he could have. He had not forgotten the grumbling of the alumni over Vanderbilt's slow start. Nor had he endeared himself to them by remarking, after a loss to Georgia Tech, that "no Vanderbilt player could make the Georgia Tech varsity."

"I think Red made the right move," observed Mrs. Sanders. "At Vanderbilt and in Nashville I think they would have thought of Red as a second string quarterback."

No sooner was Sanders hired than California newspapers tossed him a hot potato. One paper didn't even wait for him to arrive on the scene, telegraphing to ask how a Southerner would feel about having Negroes on the squad.

"You might say I'm prejudiced," he telegraphed in reply. "I'm definitely prejudiced in favor of any boy who can play football. I am intolerant, too—in-tolerant of any player who won't block or tackle."

Red, of course, has used many Negroes in his UCLA powerhouses; fact is, a tackle named Harry Thompson was the workhorse of the squad in Sanders' very first year at UCLA. And this fall Hardiman Cureton, 210-pound Negro guard, is the standout of the rugged Bruin line.

Sanders restated his formula for coaching success as soon as he became ac-

## Since 1926! The Halvorfold

Loose-leaf Pass Case, Billfold, Card Case. Note exclusive features. Read Special Offer below

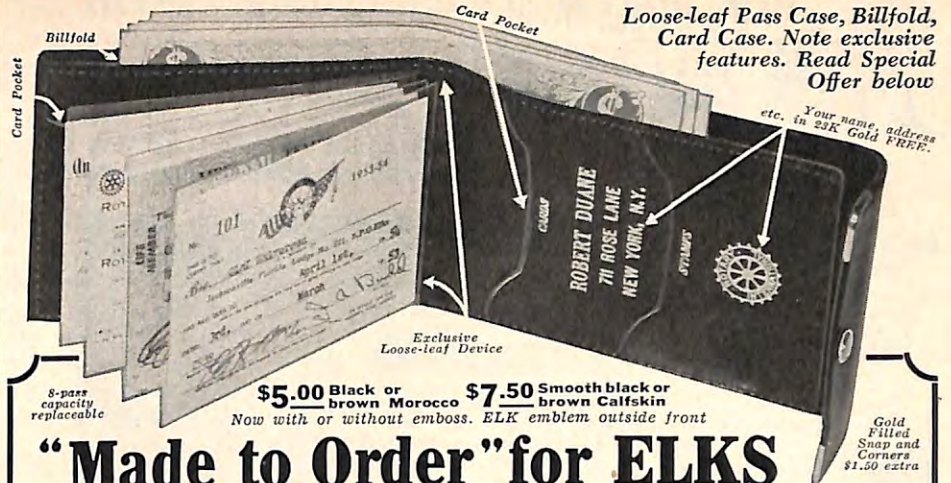

### "Made to Order" for ELKS

NOW in its 29th year—The HALVORFOLD bill-fold, pass-case, card-case. Just what every Elk needs. No fumbling for your passes. Unsnap Halvorfold, and each pass shows under separate, transparent face, protected from dirt and wear. Ingenious loose-leaf device shows 8, 12 or 16 membership cards, photos, etc. Also has three card pockets and extra size bill compartment at back. Made of the Finest, Genuine Leathers (see above) specially tanned for Halvorfold. Tough, durable and has that beautiful, soft texture that shows real quality. All nylon stitched, extra heavy. Just the right size for hip pocket. Backbone of loose-leaf device prevents breaking down. You can't wear out the leather body of Halvorfold.

**Free Examination!**  
Send No Money—Pay No C.O.D.

Means exactly what it says. No strings. Mail coupon. Halvorfold comes by return mail. Examine it carefully. Slip in passes and cards. See how handy it is. Show it to your friends and note their admiration. Compare it with other cases at more money. I trust Elks and all the Mrs. Elks, who buy annually, as square-shooters. And I am so sure the Halvorfold is just what you need that I am making you the fairest offer I know how. Send coupon.

**FREE** in 23K Gold. Name, Address and any Emblem. Would ordinarily cost \$2.50 extra. Ideal Gift with friend's name and any fraternal emblem.

**HALVORSEN, P.C.M.—STATION G, JACKSONVILLE, FLORIDA, Dept. 73**

Send Halvorfolds for free examination as per instructions below. If I decide to keep them, I will send check at once. If not, I will return merchandise in three (3) days and call the deal closed. (Halvorfolds come regularly for 8 passes. For 12-pass add 25c, 16-pass 50c, etc. Check squares and PRINT Gold Engraving instructions).

Name:..... 23K Gold Inside Emblem: .....

Address.....  
5% off to save bookkeeping, if you prefer to send cash with order. Money back if not satisfied.  
Please check here:  black  brown Morocco \$5.00—Smooth  black  brown Calfskin \$7.50  Special gold filled Corners and Snap Fastener (extra protection and beauty) \$1.50 additional. Outside embossed emblem:  ELK  MASON  EAGLES  MOOSE  KNIGHTS OF COLUMBUS.



**A Treat Worth Repeating!**

**KENTUCKY STRAIGHT BOURBON**

Also available in handsome holiday gift carton

STRAIGHT BOURBON WHISKEY • 86 PROOF • ECHO SPRING DISTILLING CO., LOUISVILLE, KENTUCKY





## The OFFICE VALET

Costumers, Ward-robe Racks, Locker Racks and Check Rooms.

### An Answer to every Wraps Problem

Welded steel Valet Racks keep wraps dry, aired and "in press"...end unsanitary locker room conditions... save floor space—fit in anywhere... standard in all strictly modern offices, factories, hotels, clubs, schools, churches, institutions or wherever there is a wraps problem.



Write for Catalog CK-3  
**VOGEL-PETERSON CO.**  
1121 West 37th St. • Chicago 9, Ill.

## BE A LANDSCAPE CONTRACTOR

Make \$20 to \$60 a day. Millions of new and old homes, estates, etc., need modern landscaping. Contracting is full time job for those who want to start own business. Start with smaller projects, and work into larger jobs. We show you how. Easy-to-follow Home Study Course. Hundreds of successful graduates. Write for FREE Book.

**NATIONAL LANDSCAPE INSTITUTE**  
310 S. Robertson Blvd., Dept. E-115, Los Angeles 48, Calif.



## BOWLING SHIRT EMBLEMS

Official Emblems embroidered in full color.  
3" diameter, per doz. \$ 4.00  
6" diameter, per doz. 15.00

**RUSSELL-HAMPTON CO.**

303 W. Monroe St.

Chicago 6, Illinois

## 500 PRINTED NAME & ADDRESS LABELS 25c

To get your name on our mailing list we will send you 500 Gummed Labels printed with any name and address, for 25c! Stick on letters, pkgs., books, etc. Wonderful gifts. (SPECIAL! 5 sets \$1.00, same or different name on each set). Order TODAY! Immediate service.

Western Stationery, Dept. 1230-A, Topeka, Kansas



## DISCOUNTS UP TO 55% for ELKS families VITAMINS

Money-Back Guarantee  
**WRITE FOR FREE CATALOG**  
W & H LABORATORIES, DEPT. E  
803 E. Broadway, Glendale, Calif.

## GENUINE BRONZE TABLETS FOR LESS!



Our vast plant devoted exclusively to bronze tablet work gives you unsurpassed quality at lowest prices.

Fast mail service—Free sketches  
Write for big FREE illustrated Catalog

Honor Rolls — Awards  
Testimonials — Memorials  
"Bronze Tablet Headquarters"

United States Bronze Sign Co., 570 Broadway, Dept. E, New York 12, N.Y.

quainted with the area newspapermen—"Eighty per cent, material; 10 per cent, luck in injuries and weather; nine per cent, coaching and strategy; one per cent, masterminding and magic." He added, for the benefit of the assembled scribes, that he hoped "to beat California and Southern Cal our share of the time."

Meanwhile, Red isn't the sort to forget the fate of his predecessor, Coach La Brucherie, who now tutors the California Tech team. La Brucherie piloted the Bruins to an undefeated, untied season in 1946 and moved on to the Rose Bowl, losing there to Illinois, 45-14. The coach got the bounce after a 3-7-0 season two years later.

Nevertheless, Red now is about as secure in his job and in the community as a coach can be. The team draws huge crowds and turns a neat profit, Red seems to enjoy congenial relations with the faculty members, and undoubtedly is the most popular coach in the Conference with newspapermen. He is always good for an "angle," always willing to help on a story and the writers enjoy his gags. A young writer who didn't know of Red's love of ribbing asked innocently for a statement on tomorrow's game.

"I think we'll win if Dame Fortune is with us," he said as solemn as an owl.

One of Red's faculty friends was chiding him one day because he never gets too chummy with the players. "Why don't your boys love you like they do other coaches?"

"That's easy," laughed Red. "I'm too busy coaching them; I don't have time to court them."

Actually, Red prefers to remain aloof, leaving the more personal relations with the players to his assistants. When he talks, the athletes listen; more often than

## A NOTICE FROM THE GRAND EXALTED RULER

*It has been brought to my attention that a few lodges have been soliciting funds in violation of Section 219 of the Grand Lodge Statutes which expressly prohibits lodges and members "from soliciting aid from sister lodges or members thereof by the sale of tickets or otherwise". This practice must be stopped.*

John L. Walker  
Grand Exalted Ruler

not they remember what he has to say. Last year the players, in one game, were scattered about the dressing room at halftime when Sanders walked into the room.

"Walker (not the boy's real name), do you feel like playing any more?"

Before the youth could answer, Red growled, "You looked like a model out there, walking around without a spot on your uniform."

One of Red's long-time assistants summed it up best of all:

"Red can't stand a loafer. If you work hard he'll go all the way with you. If you don't . . . well, you just won't get to play any, that's all."

Which brings us back full cycle to Red and his material. Sanders works for the boys who work for him, which explains why the UCLA Bruins are the scourge of the West and a football power across the nation.



National Championship Ritualistic Team from Sonora, Calif., Lodge No. 1587 that won first prize of \$1,000 at the Grand Lodge Convention in Philadelphia last July. The Sonora team had a winning percentage of 93.1025. The team also won the Raymond Benjamin Memorial Plaque which is awarded each year by Napa, Calif., lodge in memory of Past Grand Exalted Ruler Benjamin, who was a member of Napa lodge. In the photograph, Exalted Ruler Lewis R. Leonard is holding the Plaque. The team from left to right: Leading Knight James A. Panero, Jr., Lecturing Knight Edwin O. King, Esquire Louis H. Blackburne, Mr. Leonard, Chaplain Ernest Olivieri, a Past Exalted Ruler, Inner Guard Jack Eddy and Loyal Knight Norbert V. Wilson.



# TRAVELGUIDE

A contest or prize plan of an all-expense paid vacation to either Miami Beach or Havana offered by National Airlines may be of interest to some of our travel-minded lodges in connection with their fund raising and other charitable work. The plan can be tailored to special requirements and includes air transportation via National Airlines, hotel accommodations and meals for two at any one of six first-class hotels, car rental for the entire period and special sightseeing trips. The cost is surprisingly moderate and National will supply promotional material and help to "put across" the contest. We can supply details.

★ ★ ★

While relaxing this winter in Miami you might find time to take a Caribbean cruise. One is now offered by the P & O Steamship Company, Municipal Pier No. 2, Miami. The cruises begin on October 27th and sailings will be made every other Thursday throughout the year. The SS Southern Cross has accommodations for more than 200 persons and the 12-day cruise calls at La Guaira, Venezuela, Curacao and Aruba in the Dutch West Indies and Santa Marta or Barranquilla, Colombia. Minimum for the full 12 days \$220 per person. U. S. transportation tax is not applicable to these cruises.

★ ★ ★

Some 54 new hotels with 10,098 guest rooms were built in 1954. The total of all hotel rooms in the United States is now approximately 1,649,000 in some 15,582 hotels of all classes.

★ ★ ★

Many lands have their "Bluebeard" legend, but the Virgin Islands in the Caribbean has a "Bluebeard's Castle," now a first-class hotel, to back up theirs. The castle was built in Charlotte Amalie for Bluebeard's thirteen wives. Later, when he showed up with a fourteenth wife, she poisoned all of the former occupants of the castle. The Islands are also full of Pirate tales and with legend and folk lore lending color and excitement, the Virgin Islands are a popular spot for the vacationer. The Delta Line's (Mississippi Shipping Co.) luxury liners make the port of St. Thomas in the Islands on their regular 42-day cruise down the Eastern coast of South America.

★ ★ ★

When you visit Detroit make it a point to see Greenfield Village and the Henry Ford Museum at Dearborn, about 10 miles from downtown Detroit. The village covers 200 acres and is dedicated to American history. It is a panorama of Colonial life in the United States and from that time to the present. It is well worthwhile for students and others interested in Colonial times.

★ ★ ★

Something new in Reno, Nevada—a hotel—without gambling facilities of any kind. (Continued on following page)

## Never Before at Such Low Cost! IMPROVED HOMESITES

### in a Fashionable Florida WATERFRONT subdivision!



**LOTS ONLY**  
**\$750 DOWN**  
**\$750 A MONTH!**  
NO INTEREST OR TAXES!  
FREE TITLE GUARANTEE POLICY!

ENTIRE PROPERTY (2,090 acres!) lies along lovely Peace River at Punta Gorda, scenic "gateway to the Gulf." Directly on U.S. 41. Note nearness to all major cities on Florida's flourishing West Coast!

- **EVERY HOMESITE** within 2 minutes of the water! River fishing and boat dockage "at your door"... world's finest tarpon fishing just 5 minutes away, in Charlotte Harbor and Gulf!
- **FREE MEMBERSHIP** in private Country Club & Yacht Anchorage! Free use of swimming pool, fishing piers, putting green, tennis and shuffleboard courts. Charter boats available.
- **JUST MINUTES**, by boat or car, from downtown Punta Gorda, thriving Florida West Coast city with schools, churches, modern shopping centers!
- **A PLANNED COMMUNITY:** lovely winding streets; dedicated sites for parks, schools, churches, and shopping; all utilities!
- **MINIMUM LOT SIZE** a roomy 40' x 125'. To protect your resale value, homesites consist of two-lot minimum. Naturally, waterfront lots include riparian rights.
- **INCREDIBLY LOW PRICES** start at \$295 per lot — just \$7.50 down, and easy \$7.50-a-month payments!
- **NO HIDDEN CHARGES** — no interest, no taxes, no closing costs!
- **IDEAL CLIMATE**—average temperature 71.2° year 'round!
- **HOMESTEAD EXEMPTION** of \$5000 yearly; no state income tax!

**EXCELLENT INVESTMENT** — for year-round living... winter home... retirement ... or for possible resale later at many times the original price!

## Fashionable HARBOUR HEIGHTS

NEAR THE GULF AT PUNTA GORDA, FLORIDA Member Punta Gorda-Charlotte County Chamber of Commerce

Charlotte County Land & Title Company Dept. RE-1  
P.O. Box 490 Punta Gorda, Florida  
Please rush FREE full-color brochure, ground plan of subdivision, and application form, so that I may have the benefit of prompt early choice.

Name .....

Address .....

City ..... Zone ..... State .....

**THIS COUPON STARTS YOU TOWARD OWNING VALUABLE WATERFRONT PROPERTY—CLIP IT NOW!**

### EASY SHOPPING

through the Elks Family Shopper  
The Elks Magazine FAMILY SHOPPER is featured on pages 26 to 42. In it you will see a variety of useful, new, attractively priced items carefully chosen so that you may buy safely and with complete confidence. It's the easy, arm chair way to shop, free from the confusion of crowds.

When buying be sure to tell the advertiser that you saw his advertisement in **THE ELKS MAGAZINE**

### GROW ORCHIDS AT HOME

**YEAR ROUND ANY CLIMATE NO EQUIPMENT** **BIG PROFITS SPARE OR FULL TIME**

World's most thrilling hobby—profitable home business. Single Orchid plant may multiply into many—each as valuable as the first. Successful home grower shows you how! Raise gorgeous Cattleyas, Cymbidiums, Epidendrums, on living-room table. Big-profit orders come from friends, neighbors, florists, etc.—also Mail Orders. Illustrated secrets of the experts in simple "show-how" language AND blooming-size Orchid plants sent at **NO RISK**. Everything you need to start—**for pleasure or profit. FREE—full details—SEND NO MONEY.** Write today, **TROPICAL FLOWERLAND, Dept. 313, 4622 Wilshire, Los Angeles 5, Calif.**

## If Your Child Is A Poor Reader

See how **The Sound Way To Easy Reading** can help him to read and spell better in a few weeks. New home-tutoring course **drills** your child in phonics with records and cards. Easy to use. University tests and parents' reports show children gain up to **full year's grade in 6 weeks!** Write for free illustrated folder and low price. **Bremner-Davis Phonics, Dept. P-19, Wilmette, Ill.**

## "TOOK IN \$217 FIRST 10 DAYS"

Some make more, some less  
We help you to start Your Own All-Year Business  
**Make Big Money!** With our easily operated, highly efficient wall washer, Chas. Stelle took in \$217 gross in first ten days. E. L. Goss took in more than \$10,000 in one year. E. C. Taber wrote, "I made \$400 gross in two weeks." And no wonder—this machine washes walls 6 times faster and better than by hand.

**Your Money-making Opportunity.** Enjoy independence—freedom from bosses, layoffs. Customers everywhere—homes, offices, schools, etc. Expenses low, profits high. No shop necessary; operate from home. Can start spare time until your full time is available.

**Lose no time. Get all facts without obligation**

**FREE BOOK! MAIL COUPON TODAY!**

• **VON SCHRADER MFG. CO.** •  
• E24 "W" Pl., Racine, Wisconsin •  
• Send at once (no obligation) your **FREE** •  
• booklet containing information about your •  
• **WALL WASHING MACHINE** and how I can start •  
• my own permanent, profitable business. •  
• Name \_\_\_\_\_ •  
• Address \_\_\_\_\_ •  
• City \_\_\_\_\_ Zone \_\_\_\_\_ State \_\_\_\_\_ •





**monroe**  
**FOLDING**  
**BANQUET**  
**TABLES**

Direct Prices & Discounts to Clubs, Churches, Lodges, Schools and All Organizations



**MONROE TRUCKS**

For storing Folding Tables and Chairs the easy, modern way. Each truck handles either tables or chairs. Construction of Truck No. TSC permits storage in limited space.



TSC Chair Truck



TSB Table Truck

**WRITE FOR CATALOG, PRICES AND DISCOUNTS**



**THE Monroe COMPANY**  
90 CHURCH STREET, COLFAX, IOWA

# Skin Sufferers

Very first use of soothing cooling, liquid D.D.D. Prescription positively relieves raw red itch—caused by eczema, rashes, scalp irritation, chafing—other itch troubles. Greaseless, stainless. 43¢ trial bottle must satisfy or money back. Ask your druggist for **D.D.D. PRESCRIPTION**.

# WANTED

**MEN AND WOMEN**

GROW MUSHROOMS, Cellar, shed and outdoors. Spare or full time year round. We pay \$3.50 lb. WE PAID O. Babbitt \$4,165.00 in few weeks. Write for **FREE BOOK**, Washington Mushroom Ind., Inc. Dept. 226, 2954 Admiral Way, Seattle, Wash.

**Exclusive NORWAY IMPORT**

**2 on a bench**

Hand-carved Norwegian bottle opener-corkscrew set . . . clever for bar, den, patio, kitchen. Hand-painted in color or enamel. Shown in LIFE 7/25. Shipped direct from craftsmen originators in Norway. \$2 postpaid. **TRADE IN COLEMAN**, International Airport Box 5-B, San Francisco, Calif. *Request free list of unusual small gift imports.*

**I Guarantee Complete Satisfaction or Your MONEY BACK**

Save money. Send for **FREE List of Fine Diamonds**. Wonderful values. Hundreds of Beautiful Gems.

**GENUINE DIAMONDS** at **Out-of-Powr** **LOW PRICES**

Unredeemed loan pledges and big buying power enable us to offer **Fine Diamonds at Prices far less than original cost**. Sent you **FREE** for **INSPECTION AND APPRAISAL**.

**PRUDENTIAL LOAN ASSOCIATION**  
**LLOYD J. BUTLER COMPANY**  
133 N. Clark Street Dept. KS Chicago 2, Ill.

**PLEASANT JOURNEY GUARANTEED**

**HULL AUTO COMPASS**

The one famous name in Auto Compasses for 22 years.

**Beaconlite** ILLUMINATED \$6.95  
**Streamline** NON-ILLUMINATED \$4.95

NOW ALSO IN NEW CAR COLORS

At Better Dealers Everywhere. Write for Literature.

**HULL MFG. CO.** P. O. Box 246 EE-10 WARREN, OHIO

The emphasis will be on casual comfort and the new 200-room Holiday Hotel will cater to hunters, fishermen and skiers in the winter.

★ ★ ★

Regular shuttle service between Hawaii

and Tahiti started on September 1st. A twin master named *Te Vega*, a 134-foot luxury schooner, will make the "Dream Trip" regularly from now on and it should prove to be a most interesting cruise.

## Rod and Gun

(Continued from page 25)

ment. He furnishes his own boat and decoys, picks his own spot, builds his own blind or crouches in the reeds, as he sees fit, and sets his own stool. This separates the duck hunters from the men who merely go duck hunting.

The most important thing is to pick the right location in the first place. As the best duck hunter I ever knew once said, "Remember, decoys and a call are merely aids to good judgment."

In other words, you can be a virtuoso on a duck call, build an invisible blind and put out a hundred decoys, and if the ducks weren't using there naturally you'll have poor shooting.

One day several years ago, I made my setup on a bar about half a mile downstream from some other hunters who were located on a backwater off the river. One of them had a call with an unmistakable tone and he blew nothing on it but a series of eight *quacks*, the first four very loud and widely spaced, the latter four somewhat lower in volume, shorter and closer together. He repeated this over and over endlessly.

Flock after flock of mallards set their wings when they were above me and sailed straight in to the master caller, usually without even a preliminary circle. I thought, "Well, I never heard anything like it before, but that guy is the world's best."

He was with a party of five or six, but the ducks kept pouring in until, about eleven o'clock, they obviously had filled

out. They picked up their decoys and left. Then I got a surprise. The mallards still set their wings over me and sailed straight in to the mouth of that backwater!

The guy was a real duck hunter, all right, but what proved it was his selection of a spot to hunt. Neither the decoys nor his calling had anything to do with the way the ducks poured in. They knew where they wanted to go and that was where they went.

Watch where the ducks are lighting and manage, somehow or other, to get there. You'll probably get shooting as long as weather and food conditions remain the same. Watch for signs that indicate ducks have been using the spot. These may be feathers on a pond or a lot of tracks and droppings on a bar where shallow-water ducks have loafed, rested and picked up gravel. Once you find a place they're using, all that remains is to return at the proper time and figure out the best setup in relation to the surroundings and the wind.

Of course, I have no doubt that all of this may sound pretty complicated to a youngster just starting out to be a duck hunter. He probably can't qualify on some of the points. Well, I can't either.

The way I have it figured, a man needs about 50 years. During the first ten, he will have enthusiasm but not much judgment. All he can do is to shoot whatever ducks he can, and keep on trying.

During the second ten he should begin

## AGENDA OF THE GRAND LODGE STATE ASSOCIATIONS COMMITTEE

1. Institution of New Lodges
2. Promotion of Elks National Foundation, and competition on State Association level.
3. Membership control through State Association officers, and membership contest on a State Association level.
4. Elks National Veterans Service Commission promotion, and rehabilitation of veterans after hospital discharge.
5. State Association Bulletin Contest.
6. Promotion of, and advice on, undertaking of Major Projects by State Associations.
7. State Association activity in all phases of service through scrapbook competition.
8. Promotion of the outstanding initiatory class in January in cooperation with the Lodge Activities Committee of the Grand Lodge.
9. Publication of the National Directory of State Associations.
10. Publication of a pamphlet on the procedure for the institution of new lodges.
11. State Associations Clinic at the Grand Lodge Convention in Chicago next July.



to learn something about ducks—where to hunt during different periods of the season and what effect different kinds of weather have on their behavior. He should recognize all species that occur in his area.

During the third ten years he should become reasonably proficient in the use of a call. He should learn how to place his decoys for various kinds of ducks under a variety of conditions. And by this time he will have become a fairly good duck shot if he is ever going to. He will seldom shoot at a duck out of range. He'll have some definite ideas about lead and he'll begin to appreciate what wind can do to his shot string. He'll concede freely that duck shooting is the most difficult form of shotgun work.

By the time his fourth decade as a duck hunter rolls around he will conclude that he really doesn't know much. He will have realized that every season, in fact, every week of every season if he

hunts a lot, the ducks can show him something new.

In his fifth decade, provided his strength and enthusiasm hold out—and they will be if he is a real duck hunter—he will be fully as good as he thought he was at the end of the first ten years. Whatever he may lack in endurance will be more than compensated for by his knowledge of ducks, duck decoying, duck calling and duck shooting.

Not many men are destined to reach this degree of ability. I only know a few. They are deadly. If their talents could somehow be transferred to all of the enthusiastic youngsters who are trying to be duck hunters, there soon would be no ducks left.

Fortunately, there is only one way to learn how to be a duck hunter. That is by hunting ducks. It is a path beset by difficulties and countless disappointments, but it is singularly rewarding, too. I'm glad I don't know all the answers yet.

## In The Doghouse

(Continued from page 44)

doing 39 breeds an injustice to name one of the 40 as best or most handsome. It's simply a matter of owner preference. But it is no injustice to say that the setters, the three varieties, are among the handsomest. Most widely seen among these dogs is the English setter, a fellow that usually wears a white coat flecked with black markings. He has a brother less often seen whose markings are blue, lemon, liver or orange and more rarely a solid white. These dogs were known in the hunting fields of more than 400 years ago. Every so often I find in my mail queries about the Laverack or Llewellyn setters as though these were separate varieties of those good dogs.

Actually, both names indicate strains of the breed. The former was named for the enthusiastic breeder Mr. Edward Laverack who, early in the last century, began breeding setters. So well did he breed that his dogs became outstanding specimens—but they were English setters, not Laverack setters. Much the same can be said for Mr. R. L. Purcell Llewellyn, another English breeder whose name, because of the care and devotion he put into the breed, became attached to the setter. But these two were English setters, not Llewellyn setters.

As you may have read here before, the English setter has two blood cousins, the Irish setter and the Gordon. The first

Let Barron's Help You

# PICK GOOD INVESTMENTS

17 weeks' trial only \$5

To help you build your capital and increase your investment income—get a trial subscription to Barron's National Business and Financial Weekly. It will give you the facts you need to make yourself a better judge of the investment values in today's markets.

No other business or investment publication is like Barron's. It is written for the man who makes up his own mind about his own money. It is the only weekly affiliated with Dow Jones, and has full use of Dow Jones' vast, specialized information in serving you.

In Barron's you are shown *what, where, and why* the REAL VALUES are, behind current security prices. You get clear, well-founded information each week . . . on the condition and prospects (the changing fortunes) of individual corporations—and on industrial and market trends.

A trial subscription—17 weeks for only \$5—brings you:

Everything you need to know to help you handle your business and investment affairs with greater understanding and foresight . . . the *investment implications* of current political and economic events . . . the *perspective* you must have to anticipate trends and grasp profitable investment opportunities.

See for yourself how important Barron's can be to you in the eventful weeks ahead. Its subscription price is \$15 a year, but you can try it for 17 weeks for \$5. Just tear out this ad and send it today with your check for \$5; or tell us to bill you. Address: Barron's, 392 Newbury Street, Boston 15, Mass. E-1155



## DEER HUNTERS

Your Deer Hides Tanned AND CUSTOM MADE INTO Beautiful Dress Gloves MOCCASINS • HANDBAGS • COATS • VESTS Deal Direct—Catalog on Request J. R. STYRES • Little Falls 1, N. Y.



## OWN a Business

If employed, start part time. Alert dealers can gross \$5 hourly profit plus \$3 on EACH serviceman. Clean, revive, mothproof rugs & upholstery on location. No shop needed. We locally train and assist you. Nationally advertised world-wide service. Quickly established. Easy terms. Send today for FREE booklet. No obligation.

Duraclean Co., 5-54N Duraclean Bldg., Deerfield, Ill.

see for yourself!

# Capra Gems

more dazzling than diamonds at 1/30 the cost!

**FREE Booklet**  
Get full facts, FREE, on the most amazing discovery of modern science—CAPRA GEMS. A miracle of science described in recent issues of Saturday Evening Post and Reader's Digest. They're more dazzling than diamonds, yet cost much less. CAPRA GEMS' refractive quality is actually higher than diamonds! Brilliantly beautiful, dazzling CAPRA GEMS are hand cut, hand polished and hand selected . . . priced within the reach of all who love fine gems. A 1-carat diamond stone costs you approximately \$1000. A comparable choice selected, 1-carat CAPRA GEM is yours for \$24, federal tax included . . . and can be bought in small easy payments.

**GET THE FACTS NOW** Valuable illustrated booklet shows a wide selection of men's and women's rings. Gives full details, including prices and settings . . . shows all CAPRA GEMS actual size. Limited supply, so send today without delay. No charge. No obligation. Get all the facts on CAPRA GEMS . . . more dazzling than diamonds. **SEND NO MONEY**

CAPRA GEM CO., Dept. EL115, P. O. 5145, Philadelphia 41, Pa.

## WASHINGTON LODGE BAND ENTERTAINS AT ELKS NATIONAL HOME



The Elks Boys Band and Majorettes from Washington, D.C., Lodge, entertained at the Elks National Home, Bedford, Va., on Saturday and Sunday, August 20 and 21, and also gave a memorable concert on the steps of the Bedford Court House. Here in this picture these outstanding young people are shown at the entrance to the Home.



**TRY IT!**  
for your own  
adding



**BURROUGHS ADDING MACHINE**

Meet Burroughs, the economy champion! Low-cost addition at its very best. And dependability, speed and ease of operation go along with the low first cost and a lifetime of trouble-free satisfaction. Call your Burroughs dealer, or our nearest branch office for a demonstration. Burroughs Corporation, Detroit 32, Michigan.



**Burroughs**

## ARE YOU A RETAILER?

If you own or are part owner or a manager of a store, the few minutes that it will take for you to fill in and return the coupon below will be helpful to us and much appreciated. This obligates you in no way.

If you have not already done so, send the coupon TODAY.

### The Elks Magazine

50 East 42nd Street, New York 17, N. Y.

MY NAME IS \_\_\_\_\_

ADDRESS \_\_\_\_\_  
\_\_\_\_\_

CITY \_\_\_\_\_ STATE \_\_\_\_\_

TYPE OF BUSINESS \_\_\_\_\_

(PLEASE CHECK BELOW)

I OWN THIS STORE  I AM PART OWNER

I DO NOT OWN, BUT MANAGE THE STORE

## Elks National Foundation — “The Joy of Giving”

Here's a much appreciated note to Past Grand Exalted Ruler John F. Malley, Chairman of the Elks National Foundation, from Miss Sharon Lou Wilson, of Springfield, Ill., who, having received a \$600 Foundation scholarship to further her education at Carthage College, wrote:

“Scholarship Foundations such as the Elks, which make it possible for students to obtain a college education, certainly are an inspiration to every young man and woman. Although good scholarship and active civic work are rewarding in themselves, the possibility of furthering these works is a great contribution to the future of America. I shall do my utmost to fulfill your expectations of me as a national contest winner of the Elks National Foundation.”

Chairman Malley of the Elks National Foundation forwards this letter from William Tiffany of Shawnee, Okla., who received one of the 1955 “Most Valuable Student” awards, as an indication of what these scholarships mean to the young people who receive them:

“I owe a great deal to your organization and hope that I can partly repay it through diligent study during the next few years. I regard the Elks as a truly great organization and hope that I can make its ideals and purposes guide my life.”

Exalted Ruler Wilbur P. Werner of Cut Bank, Mont., Lodge, in writing to Past Grand Exalted Ruler Malley about a Foundation Scholarship Award to Dorothy Ann Maguire, who was spon-

sored by Cut Bank Lodge, sums up very well the general feeling of Elks who sponsor worthy young people for Foundation Awards. “Too few of the Elks realize the importance and good of the National Foundation. This award to a young lady who was sponsored by our lodge will to a great extent correct that condition locally. My most sincere thanks to you and the Elks National Foundation. Needless to say we are tremendously proud of the achievements of Miss Maguire.”

The Lady Elks of Ballard, Wash., Lodge, are taking an active part in the work of the Elks National Foundation and recently purchased three \$100 Foundation Certificates. This Ladies' Club is also working actively for the Cerebral Palsy Home, which is the major project of the Washington State Elks. In this photograph Mrs. Agnes Harper, President of the Ladies' Club, presents a check for \$300 to Edwin J. Alexander, Chairman of the Grand Lodge Committee on Lodge Activities and a member of Aberdeen, Wash., Lodge, for the Cerebral Palsy Home.



as you know is a handsome red coated fellow, a mite stubborn and not quite so easy to train, the second is a Scotch dog developed by the Duke of Gordon. The latter is black and tan and isn't often seen outside of hunting and show circles. He, too, is a good-looking chap. All three are about the same size.

There are five retrievers but the most popular are the Labrador and the Chesapeake. Both breeds are approximately the same size and both are endowed with remarkable swimming power with coats unusually resistant to water. In fact, in the standard for the breed submitted for approval by the A.K.C. (and approved by that body) it was specified for the Chesapeake that “The Chesapeake's coat should resist water in the same way that a duck's feathers do. When he leaves the water and shakes himself his coat should not hold water at all, being merely moist.” From the standpoint of beauty

the golden retriever is probably the handsomest. This is a Russian dog that was considerably refined in the hands of English breeders. He is a beautiful golden color and a truly noble looking dog. He has an excellent record in the field, too. But he doesn't score very often, as his is not a widely distributed breed in this country. There are the curly-coated and flat-coated retrievers, but neither are very well known outside of breeding circles. The weimaraner referred to earlier is said to be an expert huntsman's assistant. He is further distinguished by the color of his coat, a smooth coat of varying shades of grey. The breed was developed by the nobles of the court of Weimar, Germany, originally as an all-purpose breed. In its early days it was restricted to Germany and no dogs of the breed were permitted to leave the borders of that country. According to the standard of the Weimaraner Club of



# WHERE TO RETIRE TODAY AND AFFORD IT

3 books that give you the facts on where you can retire today on the money you've got

## WHERE WILL YOU GO IN FLORIDA?

Florida needn't be expensive—not if you know just where to go for whatever you seek in Florida. And if there's any man who can give you the facts you want, it's Norman Ford, founder of the world-famous Globetrotters Club. (Yes, Florida is his home whenever he isn't traveling!)

His big book, *Norman Ford's Florida*, tells you first of all, road by road, mile by mile, everything you'll find in Florida, whether you're on vacation, or looking over job, business, real estate, or retirement prospects.

Through his experienced advice you can learn exactly where you can retire now on the money you've got, whether it's a little or a lot. (If you need a part-time or seasonal job to help out your income, he tells you where to pick up extra income.) Because Norman Ford always tells you where life in Florida is pleasantest on a small income, he can help you to take life easy now.

If you're going to Florida for a job with a future or a business of your own, his talks with hundreds of business men and state officials, etc., let him pin-point the towns you want to know about. If you've ever wanted to run a tourist court or own an orange grove, he tells you today's inside story of these popular investments.

Yes, no matter what you seek in Florida, this big book (with well over 100,000 words and plenty of maps) gives you the facts you want. Price—only \$2, only a fraction of the money you'd spend needlessly if you went to Florida blind. Use coupon to order.

America, the parent club had authority to force the right breeding to the point where specimens not measuring up to the physical and temperamental requirements set for the breed were destroyed, with the result that there never have been more than 1,500 weimaraners in Germany. Eventually the embargo was circumvented and a few of the dogs found their way into this country. Today the breeding standards are still high. Originally an all-purpose dog, this fellow later became a trailer and still later a retriever having no superior on land or water. The weimaraner is a clean, quiet and exceptionally intelligent dog and due to its scarcity is seldom a kennel dog. However, if you're looking to buy one be prepared to lay quite a few chips

put into effect by the Nationalist Government is the land-to-the-tiller project. It is the only one of its kind in the entire Far East worthy of mention. A similar program in Japan contributed heavily to financial inflation when landowners were paid in cash for their land. In Korea there was not sufficient wherewithal to support it adequately. In the province of Kashmir, in northwest India, the Indian Government simply confiscated the land from its owners without compensation, and distributed it to the peasants.

## BARGAIN PARADISES OF THE WORLD

This is a book on how to double what your money can buy. For that is what spending a few weeks or months or longer in the world's Bargain Paradises amounts to.

And why not when you can retire to:

**The Azores or the Canaries**—islands of tropical flowers, sandy beaches, and the charm of Old Spain—with rents of about \$20 a month, groceries for a couple at \$10 a week, and servants \$5 a month each.

**The lotus-covered mountains lakes of Kashmir**, where a furnished houseboat with four turbaned servants rents for \$70 a month. Total costs for a couple run about \$175 a month—in the most beautiful spot on earth.

**The South Seas?** Tahiti has found out about the Yankee dollar. But there's brilliant Sigatoka Beach at Suva or reef-girt Norfolk or Lord Howe Island, the Bargain Paradise of the South Seas today.

Throughout this big book you learn where to spend a while in the West Indies, Mexico (where living costs dropped 33% when the peso was revalued last spring), South America, or the marvelous Balearic Islands where two can live like Kings for \$35 a week.

You read about cities and towns where it's always spring, about mountain hideaways, tropical islands as colorful as Tahiti but nearer home, modern cities where you can live for less, and surf washed coastal resorts.

If you've ever wanted to travel but wondered how you could afford it; if you have a little income but wonder how you'd ever be able to retire on that; if you want a life of luxuries on what you'd get only necessities back home, then you want *Bargain Paradises of the World*.

96 photos, 4 maps. 1955 edition. Price \$1.50.

on the table because the dogs are relatively few and highly valued.

There are two varieties of spaniel, chief of which is the familiar cocker, perhaps one of the most popular breeds in the United States right now. While these little fellows were bred to hunt they are not used that way today as much as they were many years ago. Two varieties of cocker are the English and American. The latter is the smaller of the two and because of his smallness and insufficient strength is not very helpful in rough broken country or locations where there is dense underbrush. The English variety, being larger, is naturally stronger and is most often used when the cocker is used at all.

There are some 18 varieties of hounds

## Report from Formosa

(Continued from page 11)

In Formosa, however, a two-year detailed land survey of the entire island was made by expert agronomists, and during the following two years the farm land was apportioned to its tenant farmers on a basis wholly equitable to its previous owners as well as to the farm tenants themselves. As a result, more than ninety per cent of Formosa's former tenant farmers now own their own land, for which the previous owners have been fully compensated.

The program was put into effect by the

## WHERE TO RETIRE ON A SMALL INCOME

This book selects out of the hundreds of thousands of communities in the U. S. and its island territories only those places where living costs are less, where the surroundings are pleasant, and where nature and the community get together to guarantee a good time from fishing, boating, gardening, concerts, or the like. The book never overlooks the fact that some people must get part time or seasonal work to pad out their income.

It covers cities, towns, and farms throughout America—from New England, south to Florida, west to California and north to the Pacific Northwest. It includes both Hawaii and the American Virgin Islands. Some people spend hundreds of dollars trying to get information like this by travelling around the country. Frequently they fail—there is just too much of America to explore.

*Where to Retire on a Small Income* saves you from that danger. Yet the big 1955 edition costs only \$1.

Mail this coupon for prompt delivery

### Mail to HARIAN PUBLICATIONS

25 First Ave., Greenlawn (Long Island), N. Y.

I have enclosed . . . . (cash, check, money order). Please send me the books I checked below. You will refund my money if I am not satisfied.

- Bargain Paradises of the World, \$1.50
- Where to Retire on a Small Income, \$1
- Norman Ford's Florida, \$2.

Special offer: all books above (\$4.50 value) for \$4

Print Name . . . . .

Address . . . . .

City & State . . . . .

but the two most used in the hunting field are the beagle, largely for rabbits and the coonhound, relentless enemy of the raccoon. Oh yes, there's the foxhound, both American and English types, the latter being the larger in size. While the foxhound is a hunting dog, he's by no means a gun dog and scarcely belongs in this article.

The training of a good gun dog requires a maximum of patience and no little time to develop a good hunter. For this reason should you think to buy a well trained dog for field work don't be surprised if you find the price is higher than the proverbial cat's back. The good dog broken to the field is well worth the money, as any experienced sportsman knows.

Joint Commission on Rural Reconstruction with a total of five members—two Americans and three Chinese, one of whom, the capable and knowledgeable Dr. Chiang Monlin, is chairman. Their two-year land survey required some nine million record cards, cross indexed by land and owner. When this was completed, a valuation of 2½ times the annual market value of its crop was placed on each acre of land, based on 1949, an average good year.

The first step in the program was to



# Housework Easy Without Nagging Backache

Nagging backache, headache, or muscular aches and pains may come on with over-exertion, emotional upsets or day to day stress and strain. And folks who eat and drink unwisely sometimes suffer mild bladder irritation...with that restless, uncomfortable feeling.

If you are miserable and worn out because of these discomforts, Doan's Pills often help by their pain relieving action, by their soothing effect to ease bladder irritation, and by their mild diuretic action through the kidneys—tending to increase the output of the 15 miles of kidney tubes.

So if nagging backache makes you feel dragged-out, miserable...with restless, sleepless nights...don't wait...try Doan's Pills...get the same happy relief millions have enjoyed for over 60 years. Get Doan's Pills today!

## HERNIA (Rupture) CLINIC

Injection Treatment (Non Surgical) 1 week to 10 days in my Clinic or 6 to 8 weekly visits suffice

Also  
Hydrocele, Varicocele & Varicose Veins  
Treated by Injection Method.  
Dr. M. A. Brandon Clinic  
215 6th St. Lorain, Ohio

## GROW MINIATURE TREES FREE! SEEDS & PLAN



New fascinating HOBBY!  
\$\$\$ OPPORTUNITY! Real  
LIVING "Ming" Trees - Beautiful elm,  
orange, oak, cypress - any kind! Full  
grown but miniature. Take orders from  
Interior Decorators, Offices, Hotels, etc.  
FREE Seeds (8 kinds) - Illust. Plan, etc.  
NATIONAL NURSERY GARDENS, Dept. Z-11  
8463 So. Van Ness, Inglewood 4, California

## FREE FOR ASTHMA

If you suffer with attacks of Asthma and choke and gasp for breath, if restful sleep is difficult because of the struggle to breathe, don't fail to send at once to the Frontier Asthma Company for a FREE trial of the FRONTIER ASTHMA MEDICINE, a preparation for temporary symptomatic relief of paroxysms of Bronchial Asthma. No matter where you live or whether you have faith in any medicine under the sun, send today for this free trial. It will cost you nothing.

FRONTIER ASTHMA CO. 258-A FRONTIER BLDG.  
462 NIAGARA ST. BUFFALO 1, N. Y.

## RUPTURE-EASER

(A Piper Brace Truss) ®



Double...4.95

Right or left  
Side \$3.95

No  
Fitting  
Required

Pat. No.  
2606551

A strong, form-fitting washable support. Back lacing adjustable. Snaps up in front. Adjustable leg strap. Soft, flat, groin pad. No steel or leather bands. Unexcelled for comfort. Also used as after operation support. For men, women and children. Mail orders give measure around the lowest part of the abdomen and state right or left side or double. We Prepay Postage on C.O.D.'s.

PIPER BRACE CO.  
811 Wyandotte Dept. EK-115 Kansas City 5, Mo.

## DON'T PULL HAIR FROM NOSE

May Cause Fatal Infection

Use the **KLIPETTE** Rotating Scissors

You can cause serious infection by pulling hair from nose. Ordinary scissors are also dangerous and impracticable. No better way to remove hair from nose and ears than with KLIPETTE. Smooth, gentle, safe, efficient. Rounded points can't cut or prick skin.



So Simple!

Just turn end Surplus hair comes out easily, gently.

\$1 Made from fine surgical steel

Chromium Plated

Guaranteed to Satisfy or Money Back

HOLLIS CO. - 1133 Broadway, New York 10, N. Y. - Dept. B-5  
Enclosed is \$1.00 for KLIPETTE. If I am not entirely satisfied, I may return it within 10 days for refund.

Name \_\_\_\_\_ Address \_\_\_\_\_

place a top limit of 37.5 per cent on payments of crop by the tenant-farmers for their combined rent, interest and taxes, which practically reversed in the tenant-farmers' favor the previous percentage paid out and retained by them. Since then, the figure of "37.5" has become a byword in Formosa, and the Formosan farmers grin happily at the mere mention of it.

This immediate improvement in the condition of the tenant-farmers lasted two years until the land survey was completed. Then the final step of the program was put into effect. Each landowner was allowed to retain, whether he cultivated it himself or not, 7.5 acres of farmland. All in excess of this amount was sold to the tenant-farmers who actually worked it. The owners were paid 30 per cent of the sale price in stocks in Formosa's cement, fertilizer and other large industrial plants (these stocks have already jumped in market value from Formosa \$2.00 to \$9.00), and 70 per cent in Land Bonds entitling them to twenty semi-annual payments in crops from the land over a period of ten years. Government public land, formerly the property of Japanese, was distributed on the same basis.

TO COMPENSATE for the nation's inability to broaden its agricultural base, because only one quarter of Formosa is arable, the Government has introduced new agricultural methods which the former tenant-farmers, now landowners, are voluntarily and eagerly adopting. These are bringing four crops a year where only three grew before; they are teaching the farmers modern scientific methods of pest control, and furnishing the wherewithal with which to apply them. As a result, Formosa is now self-sufficient in food. And, having given buying power to farm families who until now were hand-to-mouth sharecroppers, and who are now purchasing farm implements and consumer goods, new industries are springing into being with consequent great increases in industrial employment.

The man principally responsible for initiating this magnificent achievement is Chen Cheng, who has spent most of his sixty years in the military service of his country. He is a four-star general who at various times has been Chief of Staff, Minister of War, and Premier of the Republic, and who last year was elected Vice President. He realized that it was the failure of his Government to carry out land reform on the mainland that gave the Communists their most effective propaganda weapon among the peasant masses, and he was definitely determined that that error should not be repeated in Formosa.

I called on Vice President Chen at his home, a comfortable little house almost in the heart of Taipei, set back from the roadway and fronted by a picket fence and grass lawn so that, once inside its

gate, it seemed far removed from the clangor of the city streets only a few short steps away.

Of medium height, slender to the point of seeming frail, courteous in the tradition of Old China, the Vice President might easily be mistaken, by one unacquainted with his record, for an elderly Chinese scholar with horizons limited to academic reflection. Except for his dark gray eyes which twinkle with amusement while he exchanges pleasantries with his guest, but which, when he speaks of the Communists on the mainland, turn to glittering points of hard, cold steel.

Chen Cheng believes that the Western world is naive in its approach to the world Communist problem. "Communist aggression," he says, "knows no bounds. The Soviet and its satellites now occupy most of the earth. They will want a breathing spell to prepare to get the rest of it. Giving up Indochina is making neutralists out of the southeast Asian countries. It has led people in this part of the world to wonder whether the American people really understand what is going on.

"The Communists," he continued, "are not changing their aims or their strategy. They are altering their tactics with talk of cease-fire, compromise, concessions, and round-table conferences, in order to confuse the Western nations and to make them into neutralists too; and to create divisions among the American people, and to divide them from their allies."

He paused for a moment while we sipped our tea, and I waited for him to continue. I felt he wanted to choose carefully the words with which he wished to make his own position, and that of his Government, unmistakably clear.

"By now," he said, "you have seen for yourself what we are doing here in Formosa. We are doing it for a definite purpose. We are not going to co-exist with Communism only as long as it is willing to let us live. We will not give up one more inch of territory anywhere, and that includes the offshore islands. And when we are ready, we will go back to the mainland, and our chances for doing that are growing better every day."

In addition to having transformed Formosa's agricultural economy, the Joint Commission for Rural Reconstruction (JCRR) undertook other responsibilities bearing directly upon the welfare of the farmer and his family. They established 362 health stations, two-thirds of which are staffed each with full-time physicians and nurses, the others with nurses only.

The health stations are not handouts by the National Government. They are built by the local villages, under JCRR guidance. When the type of clinic specified by JCRR has been built and equipped, JCRR provides a kit of essential medical supplies, furnishes bicycles for home-visiting midwives, supplies radios (already some 6,000) in farm areas to receive the "Farmers Hour" program and health and disease prevention pro-





Tenant farmer on Formosa brings his rice to the Farmers Association. He receives a receipt which he uses as first installment for purchase from the government of the land he tills.

grams. These activities come under the direction of the Provincial Health Administration, and are tremendously effective.

Take, for example, a health station I visited in a typical farm community a few miles north of Taipei. There are 1,280 people in the area served by this clinic. When the station opened, there were 694 cases of trachoma—more than half the population—in this one district alone. In the three months since then this was reduced by the almost unbelievable figure of 90 per cent, through direct medical treatment and disease prevention education. Other diseases common to the Far East, because of lack of adequate knowledge of personal hygiene and lack of knowledge of the manner in which diseases are communicated, are being similarly attacked and reduced in incidence. Tuberculosis, of which there are five million known cases on the island, is one of them.

FOR centuries, scholarship was greatly revered in China, probably because so few of the people were able to attain it, and to the illiterate masses the ability to read and write words that conveyed meaning seemed to border on the miraculous. Even until fairly recently it was estimated that as many as 80 per cent of all the Chinese people were totally illiterate. Today, in Formosa, under the many reform programs simultaneously being conducted, 87 per cent of all children of school age are in school. And the National University in Taipei, which until the end of World War II was restricted to Japanese, now houses several thousand Chinese students who are being educated in its colleges in a variety of professions and sciences.

Farmers in Formosa, most of them sharecroppers until a year or two ago,

are building brick houses. This, for a Chinese farmer, is something new under the sun. He buys his seed and fertilizer and sells his crops through the Farmer Association, a non-governmental cooperative, in his district. When you consider that an average brick farmhouse costs Formosa \$40,000 (U. S. \$2,000), and that there are no building loans of any kind available and that the houses must be paid for in cash, and that they are springing up on farms all over the island, the transformation in the status of tenant-farmers and their families on Formosa becomes quite clear.

Native industries are expanding rapidly, and new industries are continually being introduced. Consumer goods, soaps, toiletries, cotton goods, and an almost endless variety of others, are being manufactured in Formosa in competition with imported products, and are doing extremely well. Basic industries, aluminum, cement, fertilizer, heavy machinery, shipbuilding, and others, each year employ increasing thousands of workers who are being trained in a new variety of skills.

Typical is the Chinese Petroleum Corporation, which imports two million barrels of crude oil a year from the Near East, refines it in the gigantic refinery built at Kaohsiung, in southern Formosa, and pipelines a multitude of finished products to every part of the island. Forty-one year old Jerome Hu, a chemical and petroleum engineer, who took me on a tour of the refinery, is not only its manager, but bears in addition the responsibility of caring for its 1,800 employes, many of whom live in houses on company premises.

Most of these large industrial plants, some of which are government owned, are financed by United States Government dollars. If American financial aid should stop, for any reason, it is probable

## I PAID \$20 FOR A NEWSPAPER AND MADE \$3,000

By a Wall Street Journal Subscriber

The day I picked up a copy of The Wall Street Journal in a hotel lobby was a turning point in my life. I saw right away that here was a tool that would help me earn more money. So I started reading The Journal regularly.

I was not mistaken. Now I know why men of wealth and prestige read The Journal. It is part of their secret. It is one of the things that helped them get where they are. The \$20 I spent for a year's subscription to The Journal helped me add \$3,000 to my income.

This story is typical. The Journal is a wonderful aid to men making \$7,000 to \$20,000 a year. To assure speedy delivery to you anywhere in the U.S., The Journal is printed daily in four cities—New York, Chicago, Dallas and San Francisco.

The Wall Street Journal has the largest staff of writers on business and finance. It costs \$20 a year, but in order to acquaint you with The Journal, we make this offer: You can get a Trial Subscription for 3 months for \$6. Just send this ad with check for \$6. Or tell us to bill you. Address: The Wall Street Journal, 44 Broad St., New York 4, N. Y. EM-11

## LAW...

**STUDY AT HOME** Legally trained men win higher positions and bigger success in business and public life. Greater opportunities now than ever before. **More Ability: More Prestige: More Money** We guide you step by step. You can train at home during spare time. Degree of LL.B. We furnish all text material, including 14-volume Law Library. Low cost, easy terms. Get our valuable 48-page "Law Training for Leadership and 'Evidence'" books FREE. Send NOW. **LASALLE EXTENSION UNIVERSITY, 417 South Dearborn Street** A Correspondence Institution, Dept. 11328L, Chicago 5, Ill.

## REAL ESTATE BE A BROKER

**PAYS BIG! SEND FOR FREE, BIG, ILLUSTRATED CATALOG NOW!** Graduates report making substantial incomes. Start and run your own business quickly. Men, women of all ages, learn easily. Course covers Sales, Property Management, Appraising, Loans, Mortgages, and related subjects. **STUDY AT HOME** or in class rooms in leading cities. Diploma awarded. Write TODAY for free book! No obligation. Approved for World War II and Korean Veterans. **WEAVER SCHOOL OF REAL ESTATE (Est. 1936)** 2020H Grand Avenue Kansas City, Mo.

FREE BOOK TELLS NOW

## WHAT to SAY ON 1001 OCCASIONS

Practical handbook for the "amateur" speaker

Now—you need never again be at a loss for words when addressing your club or organization! **WHAT TO SAY AND HOW TO SAY IT** gives you tested models of speeches and letters that always win a hearty reception. David Belson—a prominent attorney active in community affairs for more than 25 years—not only tells you what to say but also shows you how to say it most effectively. **Send No Money! Examine the book for 10 Days FREE!** Read **WHAT TO SAY AND HOW TO SAY IT**. See how much it does for you. Then either remit \$3.50, plus a few cents postage or return the book and pay nothing.

**FILMORE PRESS,**

Dept. W2, 222 Fourth Avenue, New York 3, N.Y.

Word-for-word models you can use for:

- Nominations
- Presentations
- Appeals for Funds
- Resolutions
- Citations
- Introductions
- Installations
- Tributes
- Congratulations
- Dedications
- Condolences
- Awards
- Speech Openings
- Closing Remarks
- Greetings
- Etc., etc., etc.



**Mill-To-You Price**

**NYLON-LASTEX STOCKINGS only**

**\$7 PAIR • 2 PAIR \$12.75**  
**SAVE \$1.25**

2-Way Stretch • Closed Heel • Open Toe

High grade, knitted, sheer, surgical elastic stocking—the best at half the usual price. Full-fashioned to give gradual, uniform support from the ankle up. Prescribed by doctors for varicose veins, tired, aching, swollen legs—both men and women. Two styles: garter length and above-knee lengths. Approved for advertising by American Medical Association, so order in full confidence. Mail below coupon now.



**THE F. A. RITTER COMPANY**

4624 WOODWARD AVE., DETROIT 1, MICH.

Send me pair stockings described. Measurement around largest part of calf is \_\_\_\_\_ inches.

Check choices following:

I want Above-Knee Length \_\_\_\_\_

Below-Knee Length \_\_\_\_\_

PLAN 1—I'll pay C.O.D. plus postage. \_\_\_\_\_

PLAN 2—Here's \$7 for Pair \_\_\_\_\_ \$3.50 for One. Prepaid

NAME \_\_\_\_\_

STREET \_\_\_\_\_

CITY \_\_\_\_\_ STATE \_\_\_\_\_



**The BALL CLINIC**  
 THE BALL HEALTH SCHOOL, INC.  
 Dept. 759, EXCELSIOR SPRINGS, MISSOURI  
 Specializing since 1919 in the treatment of Rheumatism, Arthritis and associated chronic conditions  
**WRITE FOR FREE BOOK TODAY!**

**50 YARDS LACE**

We're closing out our Lace supply. Come in enchanting patterns and designs. Vals, edges, insertions, etc. in beautiful colors and full widths. For women's, girls' and baby dresses, pillow slips, decorative edgings on many articles, etc. Pieces up to 10 yards in length! NO small pieces!  
**98¢ FREE**  
**200 Buttons FREE!** Beautiful, expensive quality. All kinds, all sizes and colors. ALL NEW. No cuts. For everyday use—also some for collectors! Includes many complete sets of 6 to 12 matching buttons! You get the 200 Buttons FREE of charge when you order the Lace—none without Lace. But order TODAY as supplies are limited to Two sets per customer. Money-back guarantee.  
**BUTTONS & LACES, Dept. 698, Box 881, St. Louis, Mo.**

**FALSE TEETH**

**KLUTCH holds them tighter**

KLUTCH forms a comfort cushion; holds dental plates so much firmer and snugger that one can eat and talk with greater comfort and security; in many cases almost as well as with natural teeth. Klutch lessens the constant fear of a drooping, rocking, chafing plate. 35¢ and 60¢ at drugists. . . If your drugist hasn't it, don't waste money on substitutes, but send us 10c and we will mail you a generous trial box.

**KLUTCH CO., Box 5555-K, ELMIRA, N. Y.**

**If Ruptured Try This Out**

Modern Protection Provides Great Comfort and Holding Security Without Torturous Truss Wearing

An "eye-opening" revelation in sensible and comfortable reducible rupture protection may be yours for the asking, without cost or obligation. Simply send name and address to William S. Rice, Inc., Dept. 13E, Adams, N. Y., and full details of the new and different Rice Method will be sent you Free. Without hard flesh-gouging pads or tormenting pressure, here's a Support that has brought joy and comfort to thousands—by releasing them from Trusses with springs and straps that bind and cut. Designed to securely hold a rupture up and in where it belongs and yet give freedom of body and genuine comfort. For full information—write today!

that the Formosa industrial structure would collapse. The government and the private Chinese companies, however, are gearing their operations and their plans on the known fact that this support cannot continue forever, and hope eventually to become self-sustaining and independent of the need of foreign aid.

As Mr. K.Y. Yin, Minister of Economic Affairs, put it, Formosa has never been an independent, viable state. For fifty years it was an appendage of the Japanese empire. And before that its contacts were direct with the China mainland. Now that it is on its own it is confronted with wholly new economic problems. The answer to them, as he outlined it to me, is gradually to introduce a program of voluntary austerity until, once again, the Republic of China can be reestablished on the mainland, when Formosa will once more become a province of China instead of having to bear the entire burden of a national government in exile in the midst of civil war. His program, which he admits will undoubtedly be an unpopular one, but which he says must soon be put into effect if Formosa is to be able to stand on its own feet, is only ten words in length: Produce as much as possible, use as little as possible. Or, in even less words: Expand production, cut consumption.

SINCE I had heard much about the "double load" of government in Formosa, national and provincial, I called on the man I thought might give the best explanation for it from the Nationalist point of view, Chang Tao-fan, president of the Legislative Yuan, the National Parliament.

There is no question about the tremendous load this imposes upon Formosa. Mr. Chang agreed. But, he said, there is no alternative other than to surrender to the Communists, which the Nationalist Government will never do. The reason for maintaining a complete National Government on Formosa is simple and understandable, he said, and it may be stated in this way:

If the government on Formosa were only a provincial government, it could not accurately call itself a government of the Republic of China. The membership was elected in the several provinces of China, and represents those provinces in exile. This membership constitutes a "long parliament," as it would be impossible to hold new elections that would be representative of the several provinces until the Nationalist Government returns to the mainland. The national legislature promulgates laws for all of China even though they are not enforceable at the moment; but mainlanders are made aware of the differences between these laws and the kind of laws now being enforced on the mainland.

In other words, said Mr. Chang, this legislature is not playing at being a national government. It is actually working at being good national government, with

a full awareness that it cannot put its decrees into effect anywhere but in Formosa at the moment—but with the hope that it will attract to it the sympathy and allegiance of mainland Chinese who are beginning to find out at first-hand what Communism really means.

Throughout all Formosa a beehive activity is under way. No one, from the highest official to the lowliest laborer, is waiting for some dramatic change to take place, or hesitating because of an impending crisis. Formosa is building its way, in agriculture, industry and commerce; in education, health and social improvement; not on a day-to-day basis, but in a spirit of continuing development. The long-range hope is for return to the mainland; the immediate goal is to build and expand Formosa's own resources.

Formosa, like almost any other place on earth, is what you want to make of it, particularly if you happen to be a foreign correspondent engaged in sending spot news to your home newspaper or press service. Soviet writers who have visited the United States have reported to their Moscow journals about discrimination against the American Negro; about sharecropper hardships and intolerance in some sections of the country; about five percenter scandals in Washington; and about anything else they could find—juvenile delinquency, for example—that would present a one-sided and wholly out-of-focus picture of what the United States really is.

Many foreign correspondents approach Formosa in much the same spirit—on the lookout for a bit of scandal here, an act of subversion there, or an unjustified hardship imposed by the security authorities, and limit their reports wholly to this kind of "shocker" story. As a result, they come up with a curious kind of picture of a people who are struggling valiantly against heavy odds which we in the United State fortunately do not have to face—a picture that is as lopsided as it is unfair.

This is not universal by any means. There are some excellent reporters in Formosa who are doing a first rate job by any standard. But there are enough of them, particularly "feature writers," who seem to be doing their darndest to report only such discreditable bits of gossip as they can glean from the darker areas of the day's news, and who ignore completely the positive achievements that stand large before their very eyes.

Of all the pieces of countries that have been truncated by Moscow-Peiping mutual aggression pacts, Formosa, in this writer's opinion, is doing the best job in the entire Far East of withstanding the threat of Communist onslaught; and has the best chance of becoming the David that may destroy the Asian Communist Goliath—provided the West is not beguiled into selling the Nationalists down the river, or, by withholding the aid they need, pulling the rug out from under their feet.



# Visiting the Lodges with John L. Walker

(Continued from page 21)

nearing completion in Newport. Arrangements for this interesting trip were made by Past District Deputy R. M. Ward of Newport News.

The Grand Exalted Ruler then travelled to **NORFOLK LODGE** and was greeted at the city limits by E.R. L. A. Hudson, Donald S. McClarin, Treasurer of the Elks State Association, a number of Elks and a police escort. That evening an informal dinner party was held in his honor. On the morning of September 9th, Mr. Walker paid a visit to **PORTSMOUTH LODGE**, where he enjoyed a luncheon with the officers and some of the ladies. Grand Chaplain William A. Brown, was present, as was Faith Young, who won second place in the Virginia State Scholarship contest, and who was presented a check at the luncheon. Miss Young also received a special award from the Elks National Foundation. Second Vice-President E. L. Curtin was in charge of arrangements. That evening Norfolk Lodge gave a dinner party for the Grand Exalted Ruler which was attended by Past Grand Exalted Ruler Robert S. Barrett, Grand Chaplain Brown, State President Francis Howard, State Vice-President E. L. Curtin and many past and present officers of the lodge. Hampton, Newport News, Portsmouth, Suffolk and Onancock Lodges participated with Norfolk in the meeting which was held on the night of the 9th. There was a large group in attendance, and the principal speeches were made by Dr. Barrett and Mr. Walker. The following morning, Mr. Walker paid an informal visit to **SUFFOLK LODGE** and **PETERSBURG LODGE** on his way to his home in Roanoke. Petersburg Lodge arranged a luncheon in his honor, at which were present Exalted Ruler Joseph B. Kirkland and his wife, C.F. Curtice, Secretary of the Virginia State Association, and his wife, as well as other prominent Elks.

On September 17th, the Grand Exalted Ruler was in New York City for the Down-State Conference held at the Hotel Commodore, with Past Grand Exalted Ruler George I. Hall presiding. This luncheon meeting, at which Past Grand

Exalted Ruler James T. Hallinan made a stirring address, was attended by all Exalted Rulers and Secretaries of the Southeast, East and East Central Districts; also the District Deputies, State Vice-Presidents and Trustees of these Districts. Present were Past Grand Exalted Rulers James R. Nicholson, Sam Stern and William J. Jernick; Frank D. O'Connor, member of the Grand Lodge Auditing Committee; John F. Scilleppi, Chief Justice, Grand Forum; James A. Gunn, member of Grand Lodge Activities Committee, and Franklin J. Fitzpatrick, President of the New York State Elks Association.

The following day the Up-State Conference was held at **ONEIDA, LODGE**, with Past Grand Exalted Ruler George I. Hall presiding and Past Grand Exalted Ruler Hallinan again addressing the gathering with a forceful speech. This luncheon meeting was attended by all Exalted Rulers and Secretaries of the other seven Districts of New York State. District Deputies, State Vice-Presidents and Trustees of these Districts were also in attendance. Present were Past Grand Exalted Rulers George I. Hall, Grand Trustee Ronald J. Dunn, Chief Justice Scilleppi, Frank D. O'Connor and Franklin J. Fitzpatrick.

Following the luncheon conference at Oneida, the Grand Exalted Ruler, accompanied by State President Fitzpatrick, proceeded by a car to Seneca Falls, N. Y., making a brief stop on the way to **SYRACUSE LODGE**, where he was welcomed by Exalted Ruler Manley L. Markell and the officers of that lodge.

After a brief inspection of the Lodge facilities, the Grand Exalted Ruler and party continued on to **AUBURN LODGE** and were greeted there by Exalted Ruler William R. Kahl, District Deputy Alvin W. Burkhard and State Vice-President Phillip J. Conboy of the North Central District. About 100 members of Auburn Lodge were present at a buffet supper honoring Brother Walker, following which the party proceeded on to **SENECA FALLS**.

On September 19th, accompanied by Past District Deputy G. Kenneth Wayne, Sheriff of Seneca County, State President Franklin J. Fitzpatrick and a delegation of about 40 officers and members of Seneca Falls Lodge and surrounding lodges, Grand Exalted Ruler Walker was the guest of the Commandant of Sampson, N. Y. Air Force Base. The Grand Exalted Ruler's party lunched at the Officers' Mess and later inspected the Base Hospital and visited the Air Force Museum.

The report of the banquet given by Seneca Falls lodge that evening in the Grand Exalted Ruler's honor, as well as his remaining visits to New York State lodges, will be continued in our December issue.

### Grand Exalted Ruler's Itinerary\*

Oct.	24-25	Queens Borough, N.Y.
	26	Amherst and Hamburg, N.Y., lodges receive charters at Buffalo
Nov.	27	Albion, N.Y.
	28	Elmira, N.Y.
	29	Herkimer, N.Y.
	30	New Rochelle, N.Y.
	31	Kearny, N.J.
	1	New Brunswick, N.J.
	3	Gatlinburg, Tenn.
Nov.	4	Oak Ridge, Tenn.
	5	Knoxville, Tenn.
	6	Morristown, Greenville, Johnson City, Kingsport and Bristol, Tenn.
	9	Beckley, W. Va.
	10-12	Bedford, Va. (Elks National Home)
	15	Burlington, N.C.
	16	Salisbury, N.C.
	17-19	Hickory, N.C., State Meeting
	22	Roanoke, Va.

\*Subject to change

## Anatone gives healthful support while it slims!



Supports sagging stomach muscles. Helps you get blessed relief from nagging backache. Slims inches off your waist. The scientifically-developed ANATONE BELT now helping thousands of men in all walks of life. Made of elasticized fabric with reinforced stitching, special stays to prevent wrinkling and rolling. No crotch piece. Forget diets, forget exercises . . . results guaranteed or purchase price back. Waist sizes 26" thru 52"

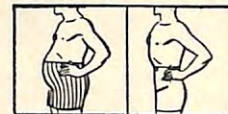
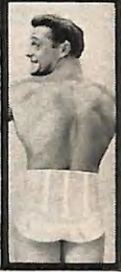

Introductory mail order price—mail coupon today.

**\$4.98**

10 day free trial . . . send no money

### MAGIC-MOLD, Inc., Dept. A18L

467 Livonia Ave., B'klyn 7, N. Y.  
Send me for 10 days' FREE TRIAL an ANATONE BELT. I will pay postman \$4.98 (plus postage). If not completely satisfied, I may return the ANATONE for full refund of purchase price.  
My waist measure is.....

Name.....

Address.....

City..... Zone..... State.....

Save money. Enclose money now and we pay postage. Same money-back guarantee. Add 50c extra on Canadian and Foreign orders. Prepaid only.



### Everlasting Bronze

### BOOK OF MEMORY

For listing 100 to 3000 names economically. Write for free folders including photos of hand-chased cast bronze plaques.

NEWMAN BROTHERS, Inc.  
Dept. 722, Cincinnati 3, Ohio

## People 60 to 80

### CAN APPLY FOR LIFE INSURANCE

If you are under 80, you can still apply for a \$1,000 life insurance policy to help take care of final expenses without burdening your family.

You can handle the entire transaction by mail with OLD AMERICAN of KANSAS CITY. No obligation of any kind. No one will call on you!

Write today for free information. Simply mail postcard or letter (giving age) to Old American Ins. Co., 1 W. 9th, Dept. L1155M, Kansas City, Mo.



# ELKS



# WORKSHOP

## Christmas project—a toy chest with “secret lock”

BY  
**HARRY  
WALTON**



THERE will be fewer toy cars, building blocks and plastic spacemen underfoot if a youngster has a chest to store them in. Add a real lock that works by a secret combination, and the chest becomes a fascinating toy in its own right. Now is the time to start building it for Christmas.

Plywood simplifies construction, especially if your dealer will cut pieces to size. The  $\frac{1}{2}$ " thickness will do for a chest up to 36" long.

The one shown is smaller—14 $\frac{1}{2}$ " high including the feet, 14" wide, and 24" long. You can change the size or proportions and still use the same design.

Cut a front and a back the same size. Make the two ends 1" narrower than the desired outside width, because they will fit inside the front and back. The bottom fits inside all four walls and therefore is the same width as the ends, but 1" shorter than the long panels. (Fig. 1).

As the drawing shows, the lid may be cut to overlap the front and ends by  $\frac{1}{4}$ ", or it may be made exact size and trimmed with quarter-round molding on three edges. This was done on the chest shown.

**CLEATS JOIN CORNERS.** Buy some  $\frac{3}{4}$ " square molding or rip one-by-twos in half lengthwise. From this cut four cleats  $\frac{1}{2}$ " shorter than the wall height. With glue and 1" screws, fasten these cleats  $\frac{1}{2}$ " inside the ends of the

front and back, flush with the top edge but  $\frac{1}{2}$ " up from the lower edge. Countersink the screws, but not so deeply that they break through.

Glue and screw the ends into the rabbets formed by the cleats, spacing the screws so that they miss the first set. It is a good idea to clamp the ends in position, taking care to align the edges, before

drilling for screws. Countersink these well.

**SQUARING UP THE BODY.** When all the screws have been tightened, but before the glue sets, measure across each pair of diagonally opposite corners. If the diagonals are equal, the case is square. If not, apply gentle pressure to the two corners that are farther apart, and temporarily nail a stick across the edges to hold them in until the glue sets.

Cut the bottom to fit inside and rest against the corner cleats. Before fastening it in, attach the feet to it with glue and two screws apiece. Attach the bottom by driving a screw through each corner into a cleat, but do not glue it in. The lock catch is easier to install with the bottom removed, although this toy chest is practical without the "secret lock".

Fill screw holes and gaps, and any holes in the plywood edges. Apply undercoat and nonpoisonous enamel.

**BE YOUR OWN LOCKSMITH.** The combination lock which will intrigue any youngster is made of dowel, an angle bracket, and four wooden checkers. It is not hard to build, but like anything mechanical, may take a bit of fussing to get working right.

Mark the centers on the checkers and drill a  $\frac{1}{4}$ " hole through, taking pains to get it square. Glue a bit of  $\frac{1}{4}$ " dowel into two checkers and file a notch in these as shown in Fig. 2.

Hacksaw one leg of a 2" angle bracket short back of the inside hole. File the remaining part slightly rounded. Above and below the inside hole in the long leg drill two  $\frac{3}{16}$ " holes  $\frac{7}{8}$ " apart.

Drill a  $\frac{5}{32}$ " hole in the center of a  $1\frac{1}{4}$ " length of  $\frac{3}{8}$ " dowel. With a file, shape it as shown in Fig. 2. Put a long 8-32 machine bolt through the original countersunk hole in the bracket and screw it into the hole in the dowel, in which it will cut its own threads. Then tighten a nut against the dowel.

The latch knob is screwed onto the bolt

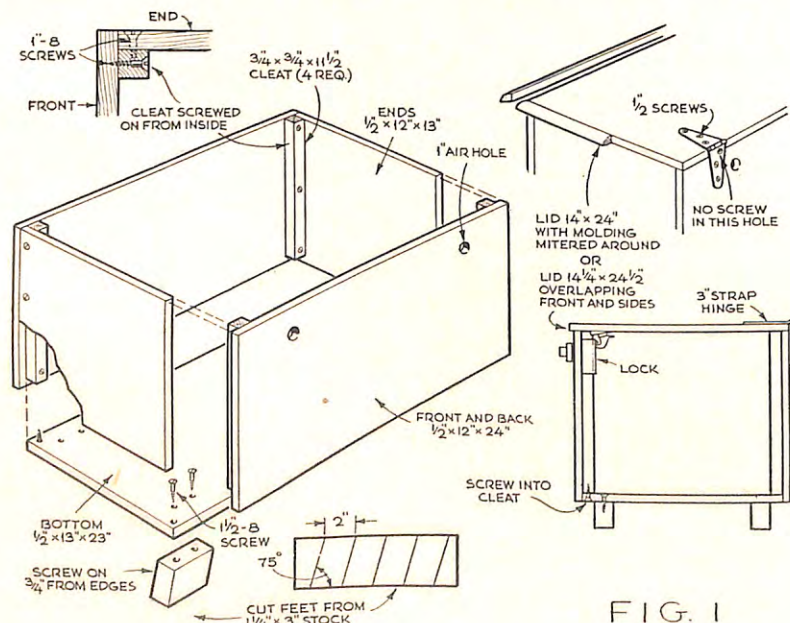

FIG. 1



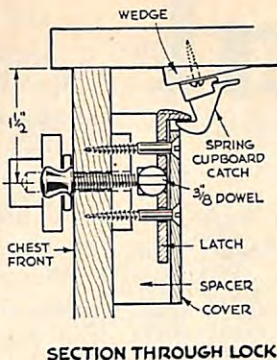
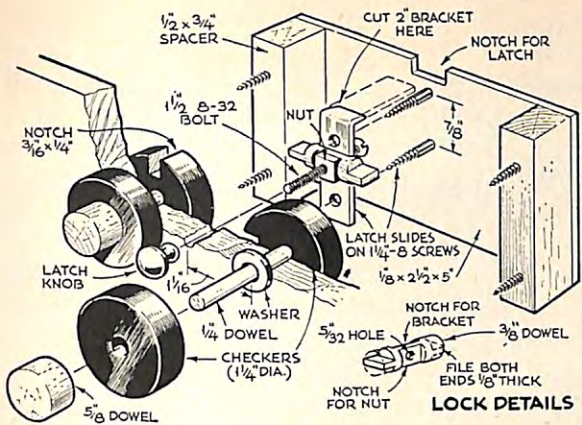

FIG. 2

outside the chest after the lock is assembled. If you can not find a knob with an 8-32 thread in it, drill a  $5/32$ " hole in a wooden knob. It will screw on tightly.

In the front of the chest drill three holes as shown in the drawing. Cut a lock cover from  $1/8$ " composition board or thin hardwood, filing a notch in it for the latch hook. Holding the latch in this notch, drill through the two  $3/16$ " holes to make matching holes in the cover. Countersink these and four mounting holes at the ends of the cover.

**ALIGNING LATCH GUIDES.** Push the latch bolt through the middle hole in the chest and hold it with a stack of washers and a nut. Put the notched checkers in the other two holes, turning them so that the dowel crossbar lies in the notches.

Now clamp the lock cover with its spacer blocks in position. Stick two  $3/16$ " drills or big nails through the matching holes in the cover and the latch, loosening the clamps if necessary to position the cover so that these line up accurately and the drills or nails are at  $90^\circ$  to the inner chest surface. Then remove them and drill through the aligned holes into the chest wall to start the guide screws.

These are simply  $1\frac{1}{4}$ " flathead wood screws. If they are correctly aligned, the latch should slide smoothly on the unthreaded part of their shanks. A short  $1/4$ " compression spring may be slipped on each, between the latch and the chest front, to retract the latch and pull the cross dowel out of the checker notches. You can buy such springs at electric-motor or vacuum-cleaner repair shops.

**USE OUTSIDE HINGES.** Because tots may lock pets, or even each other, into a box, be sure to bore two or three good-sized air holes in the back. Furthermore, use plain 3" or 4" strap hinges screwed on from outside, instead of butt hinges set into gains. Then, if the lock jams, the lid can be removed with a screwdriver.

With the lid hinged on, remove the bottom for mounting the lid catch. This is a spring cupboard catch, set on a small wooden wedge to tilt it forward. Mounted straight, it may snap open when the lid is jerked up.

The lid will snap shut even with the latch in the engaged position, thanks to the spring catch. To open the lock, the

checkers are turned to align the notches with the cross dowel, the latch knob is pulled back, and the lid raised.

**SETTING THE COMBINATION.** Slip a washer on each checker shaft and glue on the outside checker and knob. Drive a small screw near each dial as a pointer. Paint or burn figures into the edge of the checkers, or draw them on a strip of paper and glue them on.

**THE EXTRA TOUCHES.** A child's own name on the chest will make it doubly valued. It can be painted on, or the letters may be cut out of plywood and nailed on. The ones on the chest in the photograph are  $1/4$ " stock, gilded on the face and accented with bright red on all edges. (If you're not too sure about your hand lettering and numbering, the Elks Workshop, through the coupon on these pages, is making available without charge a pattern alphabet for the youngster's name and numbers for the lock.)

A lift-out tray will hold that miscellany of small things every child collects. The one shown slides on cleats screwed inside the ends of the chest. To allow the slotted lid catch to work, the tray slide on that end is made of two pieces and set off the chest wall on washers as shown in Fig. 3.

The tray can be made of plywood as shown in the same drawing, with as many partitions as desired.

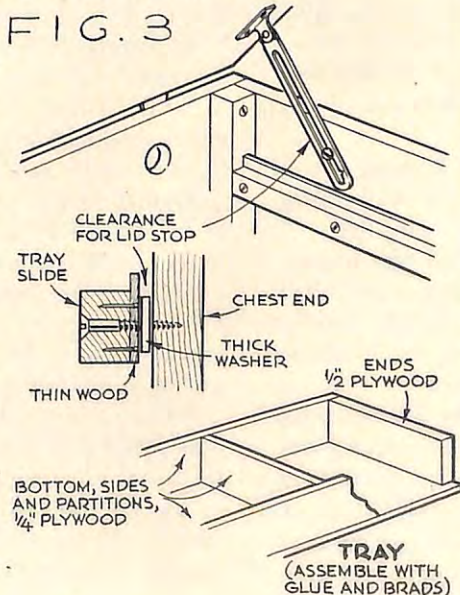

**What? POWER TOOLS only \$16 EACH!**

**EASY TIME PAY PLAN**

GRINDER  
SANDER  
30" LATHE  
HORIZONTAL DRILL PRESS  
BY TILTING TABLE SAW

**5 POWER TOOLS IN ONE**

**FACTORY TO YOU \$79.95**

SUPERSHOP offers you a precision-built complete power tool workshop, 100% ball bearing, RUGGED. Accurate. Big capacity. 15 day FREE trial. Money back guarantee. Mail postcard for FREE catalog. Buy on easy pay plan.

POWER TOOLS, INC. 1077 Yates Ave. Beloit, Wis.

VERTICAL DRILL PRESS

**Protect that gun!**

3-IN-ONE oils your gun and prevents rust—never gums up the way many oils do! Ideal for fishing tackle too!

**"3-IN-ONE" OIL**

**BUY DIRECT FROM FACTORY SAVE MIDDLEMAN PROFITS**

**MASTER MECHANIC PORTABLE LIGHT PLANTS**

(100m 24m) Push Button Start—600-700 watts 115 v. 60 cyc. AC. Powered by a rugged 2 hp. easy starting Briggs gas engine. No wiring necessary, just plug in and operate. Plenty of current for any radio, television, oil burner, freezer, pump, lights, etc. which require up to 700 watts. Ideal for camp, cottage, trailer or boat! Includes voltmeter and built-in winding to charge 6 v. auto batteries. Wt. 75 lbs. Easily fits in car trunk. Be prepared if storm knocks out power lines. Fully guaranteed. Regularly \$275 **\$143.50**

Special 1000-1200 Watt Plant (Item 46) same as Item 24 but with larger generator & engine—50% greater output **\$199.50**

Send 10c for big 1956 Catalog. Free with order. Prices f.o.b. factory. 30 day money back guarantee. Send check or M.O. Master Mechanic Mfg. Co., Dept. 52-L, Burlington, Wis.

**Alphabet Patterns for Your Toy Chest**

For those interested in building the toy chest, Mr. Walton has prepared a lettering alphabet for the child's name. The letters can be painted on, or cut out individually, and are of an informal style easy to reproduce if you want to trace them on wood to obtain the effect shown in the photograph of the chest Mr. Walton built especially for this article. Also included on the sheet are numbered strips that may be cut out and pasted around the checkers used as lock dials. Use coupon below to order. This is another Elks Workshop service offered to our readers without charge, but please enclose three-cent stamp to cover postage. Your comments are always appreciated.

**ELKS WORKSHOP THE ELKS MAGAZINE**

50 East 42nd Street, New York 17, N.Y.

Toy Chest Alphabet Pattern

Name.....

Address.....

City.....Zone.....State.....



# Editorial

## BRUCE A. CAMPBELL

In the passing of Past Grand Exalted Ruler Bruce A. Campbell, the Order loses a great and beloved leader.

When Bruce Campbell entered the Grand Lodge in 1910 he was a tall, handsome young man, possessor of a fine logical and legal mind, an impressive appearance, an unusually persuasive and powerful voice and a charm that soon brought his recognition as one of the most convincing and effective speakers in the Grand Lodge.

He had been a member of that body only a short time when he was selected as chairman of a committee entrusted with the responsibility of solving one of the most troublesome problems ever confronting the Grand Lodge, the question of legalizing State Associations and what rights and responsibilities should be given them.

At the end of three years, constitutional and statutory amendments for the legalization and regulation of State Associations recommended by his committee had been adopted by the Grand Lodge and State Associations were in operation.

Their accomplishments in the strengthening and advancement of the Order reflect his soundness of judgment, his clearness of vision and his capacity for successful concentration on the solution of a troublesome problem.

The next year he was unanimously elected Grand Exalted Ruler.

When our country entered the First World War, he became a member of the Elks National War Relief Commission.

Upon the conclusion of the outstanding service of that Commission he was made a member of the National Memorial and Publication Commission and played an important part in the creating and the managing of our Memorial Building and our Elks Magazine.

Our present Grand Exalted Ruler has taken as his slogan for the year: SERVE ELKDOM—LIVE ELKDOM.

Were he seeking an Elk properly to personify the qualities of serving and living Elkdom, he would have found in Bruce Campbell such a personification of those qualities.

Brother Campbell served Elkdom, he lived Elkdom, because he had a love for the Order that almost passed understanding.

He possessed a most unusual capacity for friendship and had thousands of friends, devoted friends. He was loyal in his friendships and they lasted through his entire life.

As Grand Exalted Ruler, Brother Campbell was responsible for the first denunciation of Communism, then called Bolshevism, by the Order of Elks and probably the first by any national American organization, when, in 1918, he said to the Grand Lodge members in Session:-

"I recommend that at this Session of the Grand Lodge strong and vigorous resolutions be passed placing our organization on record as pledged to do everything within its power to drive from this country of ours all organizations and individuals who are not in sympathy with our form of government, who do not give undi-

vided allegiance to its flag and who seek to disorganize and disrupt the great principles upon which America is founded."

The resolution that he suggested was unanimously adopted by the Grand Lodge.

Brother Campbell was married shortly after he became an Elk and had a very happy married life.

Of all the members of his family he was justifiably proud.

Notwithstanding the time he was obliged to give to his practice in the legal profession where he attained a standing of distinction, notwithstanding the time he gave to his Elk activities including contacts with lodges all over the surrounding territory and the attention he gave to that splendid movement, the Illinois State Elks Crippled Children Clinic, he was a devoted family man.

This was rendered somewhat easier by the understanding of and the affection for the Order entertained by Mrs. Campbell who accompanied him on nearly all his Elk visits through the years and is almost as well known as he among the members of the Order.

His physical strength weakened during the recent years but his spirit of brotherhood, his desire to continue fraternal associations with his brother Elks strengthened rather than diminished. Mrs. Campbell's care of him during that period won the admiration of all who have witnessed it and contributed materially to the comfort of his declining years.

In the passing of Past Grand Exalted Ruler Bruce Campbell there has gone a loyal American, and a great Elk, but he has left us the record of his service to his family, his country and to the Order of Elks that shall last forever.

## NOVEMBER



"And, therefore, I, William Bradford (by the grace of God today, and the franchise of these good people) Governor of Plymouth, say—

Through virtue of vested power—we shall gather with one accord and hold in the month of November

Thanksgiving unto the Lord."

Now comes Grand Exalted Ruler Walker reminding all Elks in his November message appearing in this issue that this year Thanksgiving week is the date selected for "Know Your America Week", which the Order has effectively supported ever since its creation three years ago.

As the Grand Exalted Ruler notes, November is the month in which plans are made for the annual Memorial Services to be held the first Sunday in December.

Also, the Lodge Activities Committee has set November as the date of a "Plan Elkdom's Progress Class" in honor of the Grand Exalted Ruler.

In November comes Veterans Day to which the members of the Order under the leadership and with the cooperation of the Elks National Service Commission, will be giving proper recognition.

And so, all in all, this November is going to be an exceptionally active one among the Subordinate Lodges and their individual members.

May all Elks accept the responsibilities and opportunities offered and meet them in a manner contributing to the prestige of the Order.





**100 YEARS IN AMERICA**



*... and still the  
National Champion of Quality*

The excitement of seeing a bird explode out of the underbrush... the thrill of watching a well-executed retrieve... these things never change for the true hunting enthusiast.

Unchanging, too, for 100 years, is the deep-down goodness and matchless quality of MILLER HIGH LIFE, the favorite beer of so many sportsmen throughout America. For the final, fitting touch to *your* day of hunting... and on *all* refreshment occasions, *enjoy life with Miller High Life!*



BREWED ONLY IN MILWAUKEE BY THE  
MILLER BREWING COMPANY FOR 100 YEARS



© Miller Brewing Company  
Milwaukee, Wisconsin



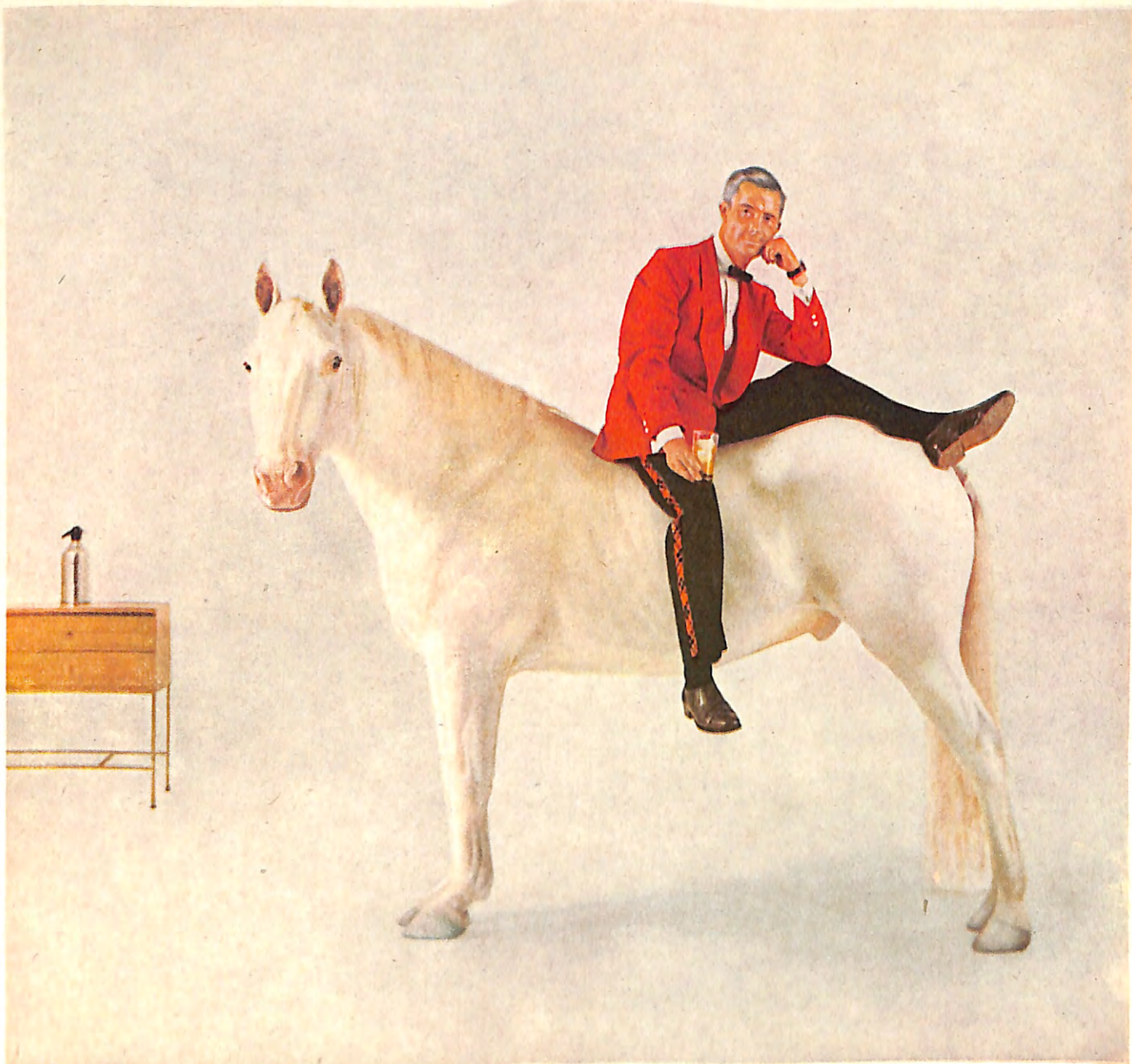

**Let WHITE HORSE carry you lightly through the evening**

*It's pre-war quality Scotch whisky.  
Still not quite enough to go around  
—but most good places have it.*



Look for the Quality Control Code on the label—your assurance of pre-war quality.