

THE

# Elks

MAGAZINE

UNITED STATES POST OFFICE



*Fred Irwin*

DECEMBER 1955

## The Elks and the Boy Scouts

BY COMMANDER THOMAS J. KEANE

*Lord Calvert* in its brilliant new gift decanter, will flatter every man

on your gift list...because only Lord

Calvert says "To a Man of Distinction".

GIFT DECANTER BY GEORGE NELSON. FOREMOST AMERICAN DESIGNER.



CALVERT DISTILLERS COMPANY, N. Y. C. BLENDED WHISKEY. 86.8 PROOF. 65% GRAIN NEUTRAL SPIRITS



## TOM WRIGLEY WRITES FROM WASHINGTON



**M**R. AND MRS. TAXPAYER can sit back and relax. They're pretty sure to get a break next year in Federal income taxes. Just what form the break will take depends upon maneuverings between Republicans and Democrats in Congress when tax reduction measures are tossed into the legislative hopper next month. It's strictly a political situation. Treasury revenues, as such, do not warrant any reduction in taxes. A presidential election will be held a year from now, however, with all of the House and one third of the Senate to be elected. Both sides, therefore, already are digging up good and sufficient reasons for giving taxpayers, meaning voters, a little relief, even though the budget is not yet balanced. The programs of that relief will make lively debate. Some Congressmen favor raising exemptions from the present \$600 to \$800 with increases also for dependents. Others are for a flat 10 percent slash in lower brackets to benefit small taxpayers, who incidentally constitute the most voters. A minority will oppose any reduction whatsoever.

### SHY SHERMAN ADAMS

Sherman Adams, assistant to the President, shuns publicity. The heavy responsibilities placed upon him during Mr. Eisenhower's illness have not changed him one whit. He stays behind the scenes but no person in Washington knows more about what's going on than the quiet former governor of New Hampshire. Gov. Adams has been at the White House all through the Eisenhower administration, yet few people would recognize him if they passed him on the street. News photographers seldom get a chance to snap his picture. His office in the White House is one of the busiest in Washington, but it is a quiet place where a staff of loyal assistants take pride in serving the "Governor" with smooth efficiency.

### LITTLE GREEN BOOK

Now that it's time for winter entertaining, hostesses nervously thumb a little green book as they plan cocktail parties and dinners. It is the new edition of "The Social List of Washington", a "Who's Who" of officials and residents with their ratings according to rank. Mrs. Carolyn Hagner Shaw of Georgetown publishes the book. Every time it

comes out she doesn't answer her phone for a couple of weeks. No one crashes Mrs. Shaw's social register. Her files of the background of Washington families are insured for \$15,000 and are kept locked in a safe. Up to 1930 social lists in Washington were based on blue blooded ancestry. But people came in with no social background, no "blood" and were accepted. Now a person gets into the little green book on official position or on social instead of family background. One seldom hears today of Washington's real "Blue bloods", the "cave-dwellers" of Georgetown as they were known.

### MAMIE'S PIE RECIPE

Here's Mrs. Eisenhower's recipe for pumpkin chiffon pie, just published in the Congressional Club Cook Book. 3 beaten egg yolks,  $\frac{3}{4}$  cup brown sugar,  $1\frac{1}{2}$  cups cooked pumpkin,  $\frac{1}{2}$  cup milk,  $\frac{1}{2}$  teaspoon salt, cinnamon and nutmeg, 1 envelope Knox gelatin,  $\frac{1}{4}$  cup cold water, 3 stiffly beaten egg whites,  $\frac{1}{4}$  cup granulated sugar. Combine egg yolks, brown sugar, pumpkin, milk, salt and spice. Cook in double boiler until thick, stirring constantly. Soak gelatin in cold water, stir into hot mixture. Chill until partly set. Beat egg white, add granulated sugar and beat stiff. Fold into gelatine mixture. Pour into pie shell and chill until set. Garnish with whipped cream. Makes one big pie or 8 individual pies. Mamie says it's her favorite recipe.

### HURRICANE TRACKER

Navy's latest gimmick to track down hurricanes is a floating weather station which is dropped in the path of the storm and automatically gives out wind, speed, and direction.

### CHARTREUSE CAUTION

His Royal Highness Prince Albert of Belgium passed his auto driver's test for the District of Columbia but stumbled on one question. When they asked him about the amber light, the Prince looked puzzled. "Amber—chartreuse", said State Dept. Protocol Officer Conger. "Oh, chartreuse" said the Prince, "Caution." The Prince came through with a perfect score.

### PILOT JUST RIDES

On newest Air Force jets the pilot will go along mostly just for the ride. As

soon as he gets it in the air and spots the target on his radar screen, he turns a few knobs and says, "Sic 'em." Automatic controls take over, steer the jet to the target, release the rockets, and turn it back for home. The pilot then lands it. All F-102 interceptors will have the new system. The mechanism has more delicate parts than 200 TV sets.

### NEW FEDERAL BUILDINGS

Washington will have nine new Federal buildings costing over \$200,000,000 in the next five years, Public Building Commissioner Peter A. Strobel reports. Four already are authorized, Smithsonian Museum, Atomic Energy Commission, Central Intelligence Agency and another State Department Building. All will be built south of Constitution Avenue, mostly where temporary buildings still are a blot on the landscape.

### NAVY COOLER

The way Navy makes its men in the service comfortable is really making Army and Air Force brass sit up and fret. They now have little electric fans inside their rubberized suits to keep them from sweating. The fan weighs a pound and is fastened to the back of the suit between the shoulder blades. It runs on a 1.3 mercury cell battery which lasts an hour. There is a hole in the back of the suit and the fan exhausts moisture-loaded air through it. In three minutes the humidity drops from 90 to 50 percent.

### POTOMAC POWDER

P. O. Dept. cleaned out its old files and got rid of enough paper to fill 170 box-cars . . . Bureau of Public Roads has openings for highway engineer trainees at \$3,415 to \$4,345 . . . A dept. store displaying sports wear put in a fish pond where kids and grownups catch trout. They put the fish in a freezer while mother shops . . . Butchers union may ask Congress for a law for compulsory inspection of poultry same as now provided for red meat . . . Busiest girl in town with sweetest disposition is Miss Rose Mary Woods, V. P. Nixon's secretary . . . Electric washing machines are tax free but clothes dryers get a 10 percent bite because they are a luxury . . . Why be lonely? There are 32 old-age clubs in Washington.

# WHAT BETTER TIME THAN NOW



...to help everybody in  
your organization enjoy  
the many benefits of

## NEW YORK LIFE'S EMPLOYEE PROTECTION PLAN

- ★ Life Insurance!
- ★ Weekly Indemnity!
- ★ Hospital and Surgical Benefits!

Firms with as few as 10 employees are eligible for this insurance plan, designed to offer comprehensive protection and to round out existing programs. For even if you already have some form of protection, your present plan may go only part way.

An Employee Protection Plan offers a flexible combination of benefits for yourself, your employees and dependents if desired. Cost is low and the plan is simple to install as well as to administer. Ask your New York Life agent for details now—in time to make it a memorable holiday for your employees.

Write: New York Life Insurance Company, Dept. EK-2, 51 Madison Avenue, New York 10, N. Y.

**NEW YORK LIFE**  
INSURANCE COMPANY

A Mutual Company  Founded in 1845

The New York Life Agent in  
Your Community is a Good Man to Know

# THE Elks MAGAZINE

VOL. 34

MAGAZINE

No. 7

NATIONAL PUBLICATION OF THE BENEVOLENT AND PROTECTIVE ORDER OF ELKS OF THE UNITED STATES OF AMERICA. PUBLISHED UNDER THE DIRECTION OF THE GRAND LODGE BY THE NATIONAL MEMORIAL AND PUBLICATION COMMISSION.

THE ELKS NATIONAL MEMORIAL AND PUBLICATION COMMISSION

BRUCE A. CAMPBELL  
Chairman  
JAMES T. HALLINAN  
Treasurer

EMMETT T. ANDERSON  
Secretary

JOHN S. McCLELLAND  
Vice-Chairman  
WADE H. KEPNER  
Asst. Secy. and Asst. Treas.

JAMES R. NICHOLSON  
General Manager  
LEE C. HICKEY  
Editor  
REGINA M. FISHER  
Associate Editor  
JOSEPH C. JONES  
Art Editor  
JOHN SCHMITT  
Circulation Manager  
GENEVIEVE G. CONOVER  
Advertising Production  
EDWARD FAUST  
Promotion Manager

EDITORIAL OFFICES, 50 East 42nd Street, New York 17, N. Y.

## CONTENTS FOR DECEMBER, 1955

COVER BY FRED IRVIN

TOM WRIGLEY WRITES FROM WASHINGTON.....	1
A FACE NEXT DOOR.....	William Holder 4
FRESCO THOMPSON.....	Harold Rosenthal 6
VISITING THE LODGES WITH JOHN L. WALKER.....	8
ROD AND GUN.....	Dan Holland 10
NOTES ON THE SPIRIT OF GIVING.....	11
NEWS OF THE LODGES.....	12
A MESSAGE FROM THE GRAND EXALTED RULER.....	15
THE ELKS AND THE BOY SCOUTS Commander Thomas J. Keane	16
FOR ELKS WHO TRAVEL.....	Horace Sutton 18
NEWS OF THE STATE ASSOCIATIONS.....	20
GRAND LODGE YOUTH PROGRAM.....	24
THE ELKS ARE PITCHING—FOR THE KIDS.....	25
ELKS FAMILY SHOPPER.....	26
IN THE DOGHOUSE.....	Ed Faust 36
A FAMILY AFFAIR.....	40
GUARD AGAINST IMPOSTORS.....	53
ELKS WORKSHOP.....	Harry Walton 54
EDITORIAL.....	56



ADVERTISING OFFICES



CHICAGO 1  
360 North Michigan Avenue  
STATE 2-6662

NEW YORK 17  
50 East 42nd Street  
VANDERBILT 6-4660

LOS ANGELES 17  
1709 West 8th Street  
DUNKIRK 8-5187

DETROIT 2  
2970 West Grand Boulevard  
TRINITY 5-7026

SAN FRANCISCO 4  
927 Mills Building  
EXBROOK 2-4073

PORTLAND 4, ORE.  
405 Times Building  
MITCHELL 4-4266

CHANGE OF ADDRESS: POSTMASTER—Please mail Form 3579 notices to: THE ELKS MAGAZINE, 50 East 42nd Street, New York 17, N. Y.

Members are asked, in changing address, to send this information (1) Name; (2) Lodge number; (3) Membership Number; (4) New address; (5) Old address. Please allow 30 days for a change of address to be effected. THE ELKS MAGAZINE, Volume 34, No. 7, December, 1955. Published monthly at McCall Street, Dayton, Ohio by the Benevolent and Protective Order of Elks of the United States of America. Entered as second class matter November 2, 1940, at the Post Office at Dayton, Ohio, under the Act of August 24, 1912. Acceptance for mailing at special rate of postage provided for in Section 1103, Act of October 3, 1917, authorized May 20, 1922. Printed in Dayton, Ohio, U.S.A. Single copy price, 20 cents. Subscription price in the United States and its Possessions, for Elks \$1.00 a year; for non-Elks, \$2.00 a year; for Canadian postage, add 50 cents a year; for foreign postage, add \$1.00 a year. Subscriptions are payable in advance. Manuscripts must be typewritten and accompanied by sufficient postage for their return via first class mail. They will be handled with care but this Magazine assumes no responsibility for their safety. Copyright, 1955, by the Benevolent and Protective Order of Elks of the United States of America

# Elks National Foundation —

## “The Joy of Giving”

Past Grand Exalted Ruler John F. Malley, Chairman of the Elks National Foundation, forwards this letter, which he received from Mrs. Macy B. Moree, of Clinton, Missouri, as an indication of the high scholarship level of recipients of the Foundation grants in the field of cerebral palsy.

“I have just received my grades from Denver University and would like to report to you that I made four A's and one B. All of my studies pertained to the rehabilitation of the handicapped. I am also happy to say that I received a Master of Arts degree in Speech Pathology and Audiology at the end of the term.”

As income tax time draws near again, it should be remembered that all donations to the Elks National Foundation are deductible. The Elks National Foundation has long been recognized by tax authorities as a worthy, charitable organization. Therefore, contributions to the Foundation Fund can be considered not only as a helpful deed, but also as a saving on income tax to the extent of the individual's deduction.

Here's another note of appreciation from a recipient of an Elks National Foundation grant—Landis M. Stetler of Baltimore, Md.

“It is my pleasure to report a very pleasant and profitable summer at Syracuse University thanks to the Elks National Foundation Grant and the authorization of the Baltimore Lodge. Considerable progress in the education and

rehabilitation of cerebral palsied children has been made all over the country. It was a most stimulating experience to learn of the most recent developments in this area and to associate with the enthusiastic people doing this work.

“May I again express my sincere gratitude to the Elks National Foundation and the Baltimore Lodge for the assistance given me.”

While many young people have the desire to continue their education, all too often the financial assistance is not available, and that is where the “Most Valuable Student Awards” of the Foundation are so helpful, as witnessed by this letter which Past Grand Exalted Ruler Malley received from Miss Ava Louise Merrill, of Portland, Maine.

“I wish to thank all members of the Elks Foundation for the financial assistance given to enable me to continue my education. Before I was notified of your award, I had every indication to believe that I could not possibly finance even a year in college. That is why I feel so indebted and grateful to you . . . you made college possible for me!

“Words could never express my deep appreciation. So it is with most profound gratitude that I wish to pay tribute in the only way I know how to your wonderful organization by saying from the depths of my heart . . . Thank You! May I prove worthy of your favor!”

Mrs. Mary Lou Rush, Director of Speech Clinic, Saint Louis University, writes as follows: “May I extend my thanks to the Elks National Foundation for expense money for Antonio Maienza's study at Northwestern University . . . We are agreed that the information and application of therapy he learned at Northwestern will be of great value in our treatment of cerebral palsied children”.



A \$500 check from the Elks National Foundation is presented by Leonard Mitchell, Exalted Ruler of Sandpoint, Ia., Lodge, to Paul Kelly at a ceremony at the lodge, while other officers look on. From left to right are: Lecturing Knight Russell Sayers, Paul Kelly, Brother Mitchell, Loyal Knight Charles Pennington and Leading Knight Earl Pedersen.

## I HAD TO EARN MORE MONEY

### So I sent \$6 to The Wall Street Journal

High prices and taxes were getting me down. I had to have more money or reduce my standard of living. Like Alice in Wonderland, I had to run faster to stay in the same place.

So I started reading The Wall Street Journal. I heeded its warnings. I cashed in on the ideas it gave me for earning extra income and cutting expenses. I got the money I needed. Now I'm slowly forging ahead. Believe me, reading The Journal every day is a wonderful get-ahead plan.

This story is typical. The Journal is a wonderful aid to men making \$7000 to \$20,000 a year. To assure speedy delivery to you anywhere in the U.S., The Journal is printed daily in four cities—New York, Chicago, Dallas and San Francisco.

The Wall Street Journal has the largest staff of writers on business and finance. It costs \$20 a year but in order to acquaint you with The Journal, we make this offer: You can get a Trial Subscription for 3 months for \$6. Just send this ad with check for \$6. Or tell us to bill you. Address: The Wall Street Journal, 44 Broad St., New York 4, N.Y. EM-12

## New Low-Cost Burroughs Accounting Machine!



A Burroughs Director Accounting Machine is priced so low it makes pen-and-ink bookkeeping expensive! Features include many big-machine advantages. A masterpiece of precision workmanship, built to do a fast, accurate, trouble-free job.

SEND THIS COUPON!



**BURROUGHS CORP.**

Detroit 32, Mich.

I want to know more about the Director Accounting Machine. ELK-120

NAME \_\_\_\_\_

ADDRESS \_\_\_\_\_

CITY \_\_\_\_\_ ZONE \_\_\_\_\_ STATE \_\_\_\_\_



# A FACE NEXT DOOR

BY WILLIAM HOLDER

*You didn't build up a character like Moran's and then throw it away overnight . . . truths you lived by couldn't be discarded for a friend.*

HAMILTON sat in his living room and watched the big trees push their shadows slowly across Chestnut Street. He had known some bad days, but this one topped them all and it hadn't ended yet. And how it would end he wasn't sure, but he thought he knew. He'd been sitting there for an hour, trying to make up his mind.

Out on the lawn, little Rob and smaller Lucy were playing with the pup Moran had given them two months before. He



ILLUSTRATED BY JOHN McDERMOTT

remembered, too, that he'd borrowed Joe's power mower last week and had forgotten to return it. Well, he'd bring it back, and he certainly wouldn't be borrowing it again for some time to come. Not if he knew Moran. You didn't build up a character like Moran's and then throw it away overnight. The truths you lived by were a part of you and you simply couldn't discard them. Well, maybe you acted out of character once in awhile, but not Joe Moran.

He gently fingered the lump on the back of his head and thought of last night. As manager, he'd been the last one out of the Mighty Market, and in his pocket had been an envelope containing the late afternoon receipts, which he would put in the night deposit box at the bank. He'd been locking the back door, near the parking lot, when he'd been

slugged from behind. He had turned and gotten a good look at the man before the blackjack had descended again and blacked him out.

He supposed it was unlucky, too, that Moran had been the detective sergeant in charge of the affair. He had told Moran that yes, he had seen the thief, and they had gone to headquarters to have a look at the rogues' gallery. They had been looking at pictures for half an hour before they came across his own. He had been as surprised as Moran. He had been younger then, and he had worn a mustache, but it was unmistakably he.

And he knew Moran had recognized the picture. There had been a sudden straightening of the heavy shoulders, a quick indrawing of breath. He didn't know whether he or Moran had made the sound. Moran had paused on the page

for only a moment, then had turned the file, and they had gone on to the other faces, the other meaningless names. Moran had not looked at him and had said nothing, but Hamilton had known.

He knew, too, how Moran's methodical mind would work. He would take no action until he was sure of what he was doing. But then he would act. Nothing would stop him, Hamilton knew. He was fully aware of Moran's reverence for the law and for his own job of enforcing it.

How long had it been, now—six, seven years? A long time that was part of the past. The past that catches up with you.

His wife came into the room. "Harry, what are you doing, sitting here alone? Come into the kitchen and help me with dinner. How does your head feel?"

He said, "Sit down, Kate. I have some  
(Continued on page 41)

# Fresco

BY HAROLD ROSENTHAL

*The Dodgers' architect  
of triumph has a  
sharp wit, but is far from  
being a clown.*

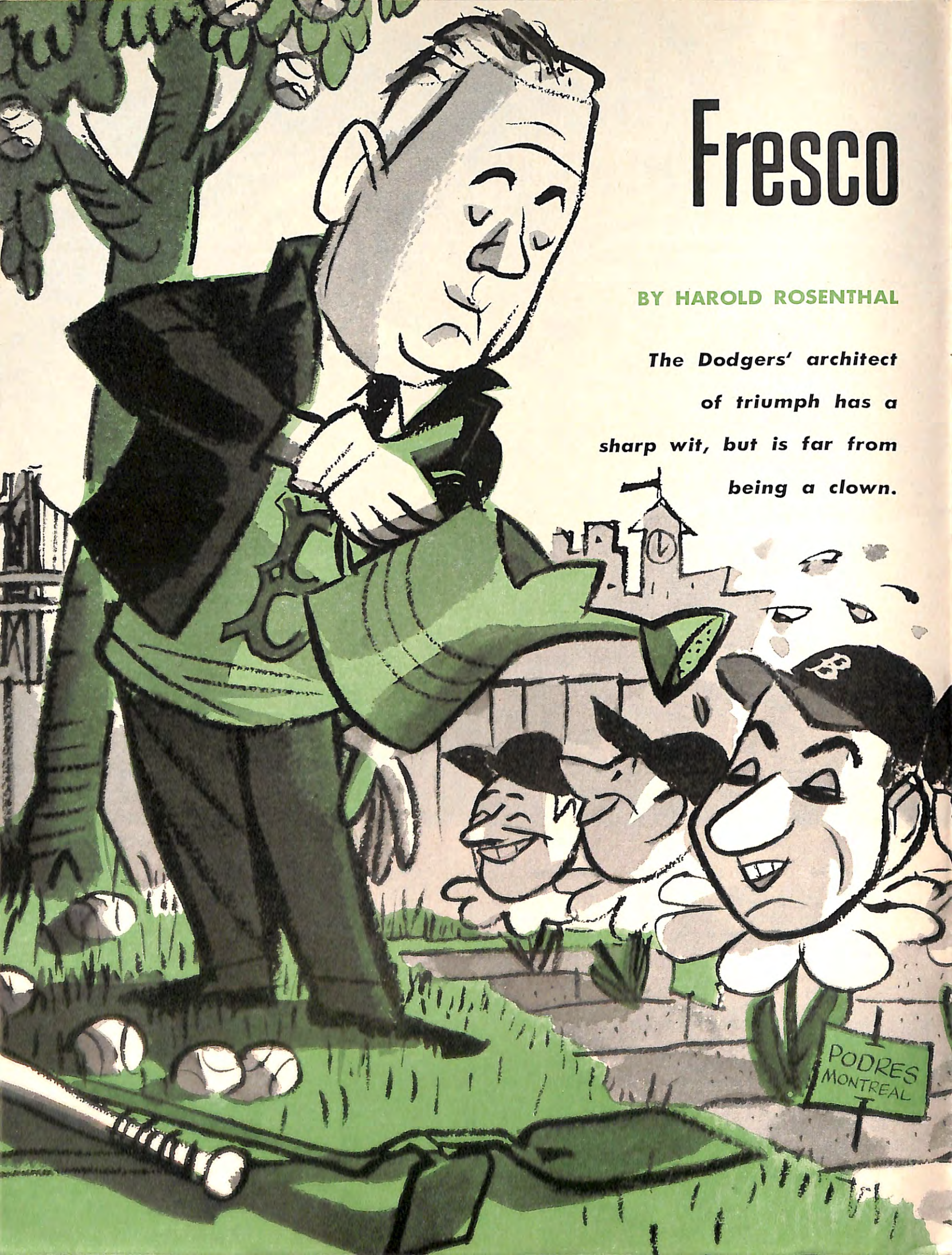



# Thompson—

## FARM BOSS WITH A GREEN THUMB

A HALF-DOZEN YEARS AGO word seeped through to a national magazine that not all baseball front-office men were bumbling, inarticulate dopes whose conversational gambits were limited to, "All we have left are a couple of seats behind a pole," or "we needed that seventh game in the World Series to break even."

There was a fellow, they were advised, Fresco Thompson, whose wit and witticisms were wafting through the major leagues—at training camps, at dreary doubleheaders, and in smoky convention halls—like some tingling ocean breeze.

An able young man was put on the job immediately; was told to leave no stone unturned to catch Fresco in print. "Go as far," he was advised, "as to actually live in Brooklyn if you think it's necessary." Fresco had just been elevated to the directorship of the Dodgers' far-flung farm system.

The young man buttonholed hundreds

of people, in and out of baseball. He carefully filled several notebooks with anecdotal material on Thompson, on Fresco the player, the manager and the front-office man. The end product looked, and read, like something vaudevillans used to buy on the installment plan from some central gag agency when they knew the act was in desperate need of a paint job but there wasn't enough money to hire a first-class gag writer to help save the act.

For Thompson the end product was a source of acute irritation from the third word of the title, "Baseball's Mr. Wise-crack," down to the last bit of Thompsoniana, the one about Brooklyn being so well equipped with mechanical devices in spring training—mechanical pitchers and mechanical ball retrievers—that "maybe (and here Fresco could be visualized as giving his straw skimmer a real saucy twirl) yessir, maybe next year we can have mechanical batters and then

we'll be able to dispense entirely with the ball players!"

"That article," declared Lafayette Fresco Thompson, vice-president of the Dodgers, his wide scholarly-appearing brow wrinkling reflectively in a slight frown below his wavy greying hair, "made me out to be something of a clown. That I'm not."

That is a sentiment to which the New York Yankees, humbled by the first World championship Dodger team in history, will subscribe one hundred per cent. Two victories by Johnny Podres murdered them—the young lefthander is a Thompson product. So are the other young pitchers who worked in the Series—the Karl Spooners, the Roger Craigs, the Don Bessents.

The Clem Labine who pitched such effective relief was brought up from St. Paul in 1951 because Thompson thought the sinker-ball ace was ready. The Sandy (Continued on page 48)

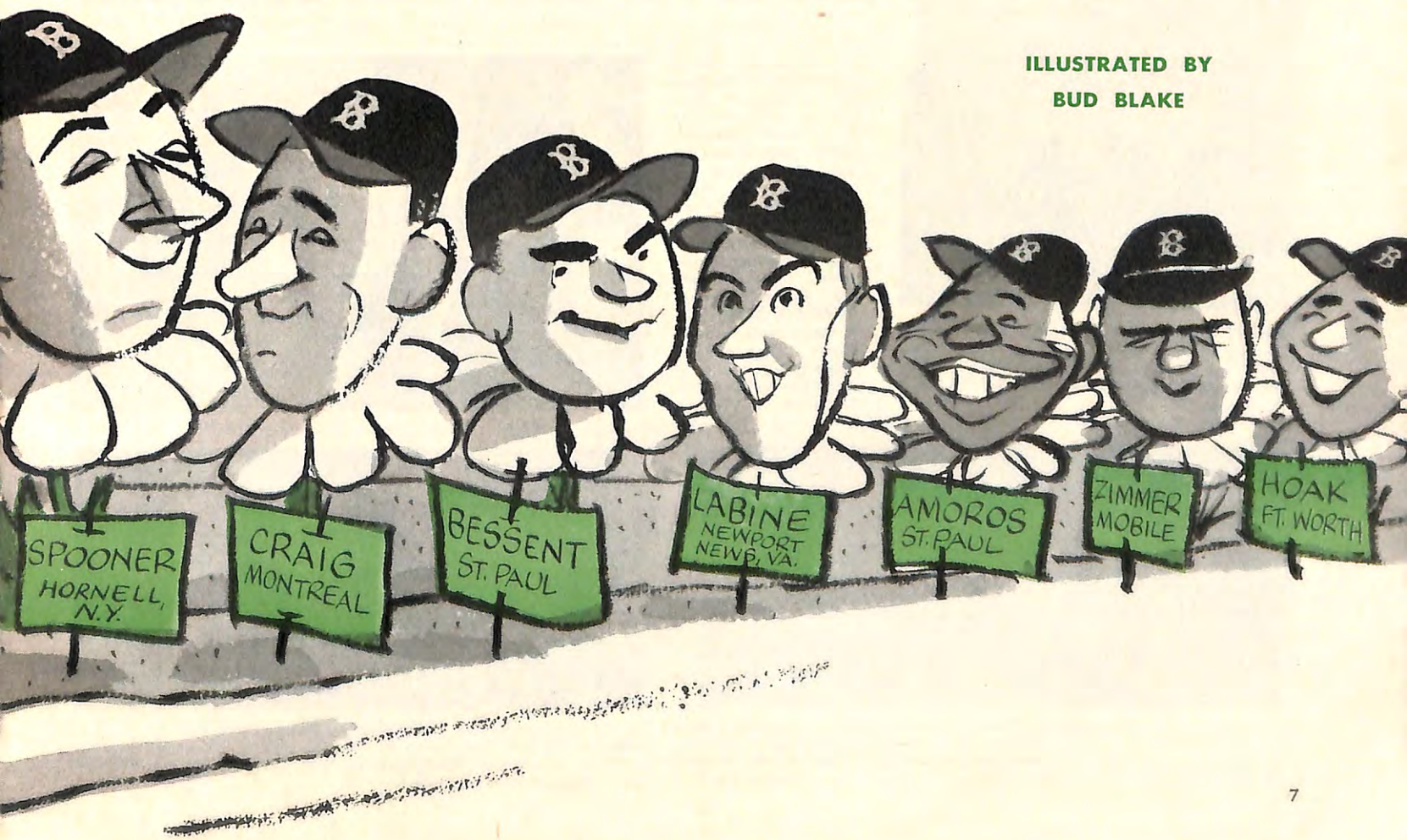

ILLUSTRATED BY  
BUD BLAKE

# Visiting the Lodges with John L. Walker



On September 26th, en route to Northampton, Mass., Lodge, the Grand Exalted Ruler stopped at Springfield and present on the train platform were, left to right: Ralph L. Atkins, Sec. Springfield Lodge; Major Albert G. Beckman, Charter Member of Northampton Lodge; District Deputy William A. Ouimet; Clifford M. Bucholz of Northampton Lodge; Mr. and Mrs. Walker; Past Grand Exalted Ruler John F. Malley; Mayor Daniel B. Brunton of Springfield Lodge and Grand Treasurer Edward A. Spry.



Present at the 50th Anniversary banquet of Northampton, Mass. Lodge on Sept. 26, left to right: District Deputy William A. Ouimet, Past Grand Exalted Ruler John F. Malley, Exalted Ruler Harry Jekanowski, Grand Exalted Ruler John L. Walker, Past Grand Exalted Ruler E. Mark Sullivan and Grand Treasurer Edward A. Spry.

IN OUR NOVEMBER ISSUE the report of the visits of Grand Exalted Ruler John L. Walker concluded with the luncheon meeting at **SENECA FALLS, N. Y., LODGE** on September 19th. That evening the Lodge celebrated its 50th Anniversary with a dinner in Mr. Walker's honor at the St. Patrick's Auditorium. This outstanding occasion was attended by about 400 Elks. The Grand Exalted Ruler's address, in which he complimented the lodge on its achievements during the half century of its existence, was the highlight of the evening. Mr. Walker presented on behalf of the lodge a 50-year pin to Charter Member Past Exalted Ruler Charles S. Fegley. Present were John Compson, P.E.R., Seneca Falls; Alvin Burkhard, District Deputy; Phillip Conboy, State Vice-President and State President Franklin J. Fitzpatrick.

The following day the Grand Exalted Ruler was at **ITHACA, N. Y., LODGE**, where his group was met by Exalted Ruler Carl W. Davis and other members of the lodge. The Grand Exalted Ruler was escorted through the Ithaca Reconstruction Home, which is a nationally known rehabilitation center for crippled children and which has received much of its support during the 35 years of its



Present to greet Grand Exalted Ruler John L. Walker when he arrived at Minot, N. D., Lodge, were Exalted Ruler L. Donald Thorson and, at Mr. Walker's right, Minot Lodge Secretary Olaf Arneberg.

On September 27th, the Grand Exalted Ruler was honored at a special reception at Greenfield, Mass., Lodge. Seated left to right: Past Grand Exalted Ruler E. Mark Sullivan, Mr. Walker, Exalted Ruler Herbert F. Sauter and Past Grand Exalted Ruler John F. Malley. Standing: Grand Treasurer Edward A. Spry; John B. Finck, Pres. Vermont State Elks; Alfred Gross, Exalted Ruler of Boston Lodge, and D.D. Raymond J. Quesnel.



Early in October the Grand Exalted Ruler was at San Diego, Calif., to attend the State Convention, and at that time was photographed with, left to right: Past Grand Exalted Rulers L. A. Lewis and Dr. Robert S. Barrett, with Past State President Morley H. Golden at Mr. Walker's left.



Left to right when the Grand Exalted Ruler visited Providence, R. I., Lodge on October 2nd, were: Mr. Walker, Dennis J. Roberts, Governor of Rhode Island, Past Grand Exalted Ruler John F. Malley and District Deputy Richard A. Moran and his wife.



Among Elks welcoming the Grand Exalted Ruler to Huron, S. D., Lodge, on October 16th were, left to right: State President Kenneth Roberts, Rapid City; District Deputy Harold F. Ricketts, Mitchell; Mr. Walker; Past Grand Exalted Ruler James G. McFarland, Watertown, and R. W. Hanten, Sec., N. D. State Elks Assoc.



This group welcomed the Grand Exalted Ruler to Mitchell, S. D., at a luncheon held on October 17th. Left to right: Exalted Ruler Robert E. Morgan, District Deputy Harold F. Ricketts, Mr. Walker, Past Grand Exalted Ruler James G. McFarland and State President Kenneth L. Roberts.



On September 3rd, the Grand Exalted Ruler was at East Chicago, Ind., Lodge to attend the 50th Anniversary event. Left to right: Past Grand Exalted Ruler Joseph B. Kyle, Past District Deputy John L. J. Miller, Grand Exalted Ruler Walker, Exalted Ruler Orville R. Bemisderfer and Past Grand Exalted Rulers William H. Atwell and Dr. Robert S. Barrett.



This photograph was taken when Grand Exalted Ruler Walker arrived at Owego, N. Y., Lodge on September 20th. Left to right, front row: Past District Deputy Arthur B. Stiles and Past State President John T. Gorman. Rear: State President Franklin J. Fitzpatrick, Grand Exalted Ruler Walker and Exalted Ruler Walter T. Shelton.

existence from Ithaca Lodge and its members. Brother Walker was interested to hear that one of the first grants ever made by the Elks National Foundation was to this home.

After a luncheon at Ithaca Lodge in honor of the Grand Exalted Ruler, at which over 100 were present, Brother Walker and party continued by car to **OWEGO, N. Y.**, to be greeted by Exalted Ruler Walter T. Shelton. Owego Lodge on that evening honored the Grand Exalted Ruler at a dinner attended by over 300 enthusiastic members of the Order. Present were District Deputy Eugene F. Hourihan and State Vice-President William A. Dicker; State President Fitzpatrick and many past District Deputies and Elk dignitaries of the District.

The Grand Exalted Ruler and his party on September 21st drove from Owego to Elmira and before boarding a plane there for Buffalo stopped at the Mark Twain Hotel, where Mr. Walker was the guest of **ELMIRA LODGE** at an informal luncheon attended by the officers of that lodge. Past State President Roy Martin was in attendance at this luncheon.

Upon arrival at the Buffalo Airport, the Grand Exalted Ruler was met by a motorcade from **DUNKIRK LODGE**, led by Exalted Ruler John A. Walters and 50th Anniversary Chairman George J. Schneider, P.E.R., for their 50th Anniversary celebration which consisted of a dinner attended by over 500 Elks and their ladies. Present were Bernard Dougherty, Mayor of Dunkirk; Edward F. James, Mayor of Fredonia; J. Theodore Moses, Past Grand Esteemed

Lecturing Knight; Ruel H. Smith, Past President Pennsylvania State Elks Association, and Franklin J. Fitzpatrick, State President. Following an inspiring address, Grand Exalted Ruler Walker presented 50-year pins to Charter Members Fred C. Koch, William L. Koch and P.E.R. Dr. Frederick B. Dudley.

The following morning, prior to leaving by car for Buffalo to enplane for Grand Junction, Colorado, Mr. Walker was the guest of Dunkirk Lodge at breakfast at the Dunkirk City Club. As reported elsewhere in this issue, Mr. Walker attended the Colorado Elks State Convention at Grand Junction.

After his departure from Colorado, the Grand Exalted Ruler returned to the East Coast for a tour of New England lodges. Mr. Walker's first visit was to **NORTHAMPTON, MASS., LODGE** on September 26th, where that evening he was the guest of honor at the lodge's Golden  
(Continued on page 38)



Standing before the television set that Seneca Falls, N. Y., Lodge presented to the Grand Exalted Ruler when he visited there on Sept. 19 are, left to right: Exalted Ruler Beryl McMillen, Mr. Walker, State President Franklin J. Fitzpatrick, P.D.D. G. Kenneth Wayne and Past Exalted Ruler Edward McNally.



Present at the dinner celebration of the 50th Anniversary of Dunkirk, N. Y., Lodge on September 21st were, left to right: District Deputy Clifford A. McNaboe, State President Franklin J. Fitzpatrick, Grand Exalted Ruler John L. Walker congratulating Exalted Ruler John A. Walters, State Vice-President Michael Lombardo and Past State President J. Theodore Moses.

# ROD & GUN

BY DAN HOLLAND

**Florida—where large-mouth bass really are large.**



**A**NYONE WHO HAS ever read a resort folder knows that Florida is the home of the renowned marlin, the high-leaping sailfish, the graceful dolphin and the rough-and-tumble tarpon. He knows, also,

that the fertile coastal waters abound in king mackerel, bonefish, amberjack and other glamorous game fish too numerous to mention. The person who has caught any of these famed fish has discovered that they are just as exciting as their advance notices would indicate, and he also has discovered, incidentally, that they are somewhat expensive.

Any Florida folder designed to attract tourist fishermen naturally stresses these spectacular salt-water fish. Near the bottom of the list and somewhat forgotten in all the excitement occasionally creeps in a name that is dirt common alongside these others; yet it is a respected and magic name among knowing sport-fishermen in all the forty-eight states. It is a name that needs no introduction and no ballyhoo. This is the large-mouthed black bass. And Florida is full of bass, plumb full of them, all the way from the St. Johns River in the north to the Everglades in the south. They not only live in every lake, river and slough, no matter how small, but some of them are pudgy old fellows big enough to pop the eyes right out of most fresh-water fishermen.

This will give an indication. As a northern bass fisherman I started out when I was hardly big enough to wrestle a worm on a hook. After a number of years of day-fishing and night-fishing, plug-fishing and fly-fishing, I finally caught a three-pounder. That was a big moment. I have kept it since with a diligence common to bass fishermen, and at this date the largest I have landed outside Florida weighed just over four pounds—and I am boasting, not complaining. In contrast was the first day I ever fished for bass in Florida. It was in the Imperial River, not outstanding by any means as Florida bass waters go. In the morning we fished downriver into brackish water, plug-casting for snook and tarpon, and in the afternoon we went upriver for bass. At about 3 pm I landed my fortieth bass, and he weighed eight-and-one-half pounds!

Any northern fisherman will admit that a four-pounder is a walloping big bass. I don't care how long a man has been

at it or how many hundreds of bass he may have caught, he will do plenty of talking when he comes home with one of that weight. And a bass more than twice that size—well, it was just out of all reason the way I was accustomed to thinking. Of course I will admit that I am a pretty good fisherman if forced into it, but not good enough to rate anything like that in the first three hours. If I could boat one that size, there are thousands of bass fishermen throughout the country who would have a right to expect one even larger.

**A**ND these bigmouths from the deep south are bass through and through. They have the same pugnacious attitude toward a lure that has made their northern brothers favorites with fishermen through the years, and they jump as well as any largemouth. That eight-and-one-half-pounder jumped clear of the water twice and broke the surface several other times. They possess the typical sporting characteristics of the bass tribe, and nothing more need be said.

Just where in Florida is the best place

Photo by Dan Holland



All you need is a rowboat and tackle to land one of Florida's large-mouthed bass.

to try for a big one, no one could predict for certain. There are literally hundreds of lakes and rivers that have bass as big as those in the Imperial. There is one place in particular, though, that I have wanted to try, and I am going to do it some day if I live long enough. This is Fisheating Creek.

One day we stopped to talk with a colorful Florida friend who was casting in one of the drainage canals along the edge of the Everglades in the southern end of the state.

"You know," he commented, dropping his lure against the opposite bank of the canal, "you wouldn't believe it to look at it, but there's fish in this little old canal 'most as long as a dog."

"Been fishing much?" one of us asked.

"Not since yesterday. Lady and her little boy were hanging around here—wanted to know where to catch a fish. Ah wasn't doing anything, so I took them out. You know, that little old boy sat on his mamma's lap and caught a big old bass. They were the tickledest people you ever did see. She talked hunting most of the time. Said she had some fine pointers up home, and maybe she's send me a pup. There's that old 'maybe' again!"

"What are you doing these days beside fishing?" someone asked.

(Continued on page 47)

# Notes on the Spirit of Giving



DEPARTMENT OF THE ARMY  
OFFICE OF THE ADJUTANT GENERAL  
WASHINGTON 25, D. C.

IN REPLY REFER TO  
AGMZ-P 005 (1 Sep 55)

The Elks National Service Commission  
3257-58 Chrysler Building East  
New York, New York

Gentlemen:

I have recently been advised by the R. J. Reynolds Tobacco Company of your latest donation of cigarettes for our service personnel in the Far East. This was the twentieth donation in the past twenty months, during which period you have donated a total of 2,100,000 cigarettes.

The Department of the Army is quite proud and grateful for the deep interest your commission has taken in our personnel in Korea. Your special efforts in continuing this project are certainly worthy of special praise.

Of immeasurable importance to any commander in the field is the morale of each member of his command. As I have mentioned previously, your continuous flow of cigarettes to service men and women in the Far East has certainly played a part in adding to their morale. In order that the Commanding General, United States Army Forces, Far East, and Eighth U. S. Army, may be advised of your continued efforts on behalf of his command, a copy of this letter is being forwarded to that command.

May I again thank you for your wonderful efforts.

Sincerely yours,

*John A. Klein*  
JOHN A. KLEIN  
Major General, USA  
The Adjutant General

On several occasions you have read here excerpts from the thousands of gracious notes the Elks National Service Commission receives from our servicemen, expressing their appreciation of the cigarettes you supply to them all through the year.

We thought you would like to know that your gifts are also appreciated by the officials who are in charge of these men.

These letters speak for themselves—including the acknowledgment sent both to Major General Klein and General White by Chairman James T. Hallinan of the Commission who assures them that we shall continue to make Christmas every day in the year for our service personnel in the Far East.

HEADQUARTERS  
UNITED STATES ARMY FORCES, FAR EAST  
AND  
EIGHTH UNITED STATES ARMY  
OFFICE OF THE COMMANDING GENERAL  
APO 343, San Francisco, California

27 September 1955

Gentlemen:

Major General John A. Klein, The Adjutant General of the Army, has forwarded a copy of his letter of 15 August, concerning the donation of cigarettes by your organization to American military personnel serving in the Far East. To this, I wish to add the appreciation of the men who will receive them.

It is especially pleasing to note that this donation included the two millionth cigarette given by the Elks National Service Commission in the past nineteen months, and that this is one of the largest totals ever amassed. Your contributions which have been distributed to United States military patients in hospitals in Korea, Okinawa and Japan have added considerably to the overall welfare of these personnel.

On behalf of the personnel of the United States Army Forces, Far East and Eighth United States Army, may I again extend our thanks to your organization for their fine work.

Sincerely,

*I. D. White*  
I. D. WHITE  
General, United States Army  
Commanding

National Service Commission  
Chrysler Building, East  
New York

JAMES T. HALLINAN  
CHAIRMAN  
ROOM 3257 - 161 EAST 42ND STREET  
NEW YORK 17, NEW YORK

HENRY C. WARNER  
VICE-CHAIRMAN  
DIXON, ILLINOIS

E. MARK SULLIVAN  
SECRETARY  
209 WASHINGTON STREET  
BOSTON 9, MASSACHUSETTS

GEORGE I. HALL  
TREASURER  
21 WEST STREET BUILDING  
NEW YORK 6, NEW YORK

HOWARD R. DAVIS  
ASSISTANT TREASURER  
319 HERBURN STREET  
WILLIAMSPORT, PENNSYLVANIA



GRAND LODGE  
Benevolent and Protective  
ORDER OF ELKS  
UNITED STATES OF AMERICA  
ELKS NATIONAL SERVICE COMMISSION

JAMES T. HALLINAN  
Chairman

I. D. White, General  
United States Army, Commanding  
United States Army Forces, Far East  
APO 343  
San Francisco, Cal.

Dear General White:

Thank you for your gracious letter of September 27th regarding the shipments of cigarettes to our service personnel in the Far East.

The heart-warming letters and postals received from the boys in Korea indicate clearly their appreciation for this little remembrance from home. The idea that they are in our thoughts seems to mean much to them.

You might be interested to know that as long as our defenders are stationed in this remote part of the world, they will never be forgotten by the Benevolent and Protective Order of Elks. We consider it, not alone our duty, but more important, a privilege to be permitted to make this simple gesture.

Sincerely yours,

*James T. Hallinan*  
James T. Hallinan, P.O.E.R.  
Chairman

FRANK J. COURT  
PORTLAND

WADE H. K...  
1208 CHAP...  
WHEELING

EMMETT T. A...  
782-788 CO...  
TACOMA.

JOSEPH B. KY...  
1222 NORTH...  
INDIANAPOLIS

WILLIAM HAW...  
UNITED STATE...  
DALLAS, TEXAS

CHARLES E. B...  
920 NORTH E...  
P. O. BOX 222...  
SHEBOGAN.

Room 3257 - 161 East 42nd  
NEW YORK 17, NEW YORK  
October 3, 1955.

# News of the Lodges



Tulsa, Okla., Elksdom was represented by 45 members and ladies in the recent 17-hour Telethon sent out over KOTV from the Tulsa Fairgrounds Pavilion for the benefit of the 200,000 muscular dystrophy victims of the country. One of the dignitaries who appeared on the telecast was Past Exalted Ruler Earl E. James, pictured at right as he was introduced by Master of Ceremonies John W. King. The Telethon realized more than \$40,000 for research work.



The 1955 Southeastern Elks Golf Tournament sponsored by the Georgia Elks Assn. found Decatur Elk Irby Broadwater on top, with East Point Lodge's Jack King, M. R. McMahon, Al Burrows and Bob Adams taking the Team Championship and the Haygood-Tolbert Trophy, center foreground. Tournament Medalist, pictured was Ralph Barnes of Atlanta.

## An Orange Lodge Grows in Texas

Under the supervision of D.D. G. M. Brassard, Orange Lodge No. 284 (its original number) returned to active participation in the Elk family with 99

members who elected Carl W. Rollins as their first Exalted Ruler. The initiatory work was capably handled by the officers of Port Arthur Lodge, No. 284's sponsor, with nine lodges of the District represented in the audience. Among the out-

A banner occasion in Saginaw, Mich., Elksdom saw the 107-man "New 47 Class," the largest group in the lodge's 69-year history, initiated as the result of the leadership of E.R. R. H. Vaughan and a hard-working Committee led by P.E.R. Norman F. Diment. Pontiac Lodge officials conducted the ceremony attended by State Pres. L. A. Koepfgen, D.D. L. M. Richard and 300 others.



ADDRESS OF GRAND EXALTED RULER JOHN L. WALKER: B.P.O. Elks Lodge No. 197, 602 South Jefferson St., Roanoke, Va.  
ADDRESS OF GRAND SECRETARY LEE A. DONALDSON: Elks National Memorial Building, 2750 Lake View Ave., Chicago 14, Ill.

of-towners on hand was D.D. John W. White of Louisiana North.

Assisting in the ritualistic work were several Past Presidents of the Texas Elks Assn., including W. S. Traill, former Grand Lodge Committeeman Raymond L. Wright, Carl R. Mann of the Grand Lodge Credentials Committee, and H. S. Rubenstein, State Secy. E. C. Bunch, Pres. of the Assn., made the principal address, and State Vice-Pres. Ed. F. Burgdorf, on behalf of other branches of Texas Elksdom presented several gifts to the new lodge.

## Newton, Kans., Elks Dedicate Home

Past Grand Exalted Ruler Henry C. Warner had high praise for the members of Newton Lodge No. 706 when he officiated at the dedication of their new home.

A handsome, \$350,000 edifice, the building was completed and occupied last February with not a debt outstanding. The formal dedication ceremonies were postponed until September, when 300 affiliates, including John B. Dickey and Milo McKee, two of the lodge's Charter Members, were on hand.

Mr. Warner's address climaxed the formal ritual, exemplified by Elk dignitaries from various Kansas communities, headed by D.D. Charles Bishop, a P.E.R. of the host lodge.

E.R. Cecil Eberle and his staff extended a welcome to the many out-of-town guests who attended both the dedication and the open house program celebrating the occasion.

## W. H. Harth, Prominent South Carolina Elk, Mourned

The sudden death of William H. Harth on Sept. 12th brought sadness to his many friends throughout Elksdom. An active and devoted leader in the affairs of Columbia, S. C., Lodge, No. 1190, Mr. Harth had served that branch of the Order as Exalted Ruler on five different occasions, the first time in 1927.

Following a year as District Deputy, he became Secretary of Columbia Lodge in 1931, a post he held until 1937. In

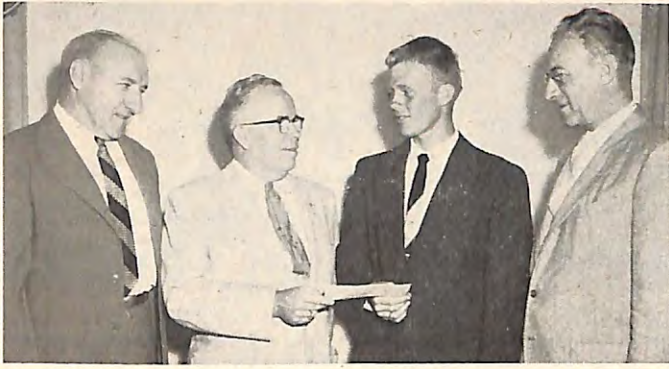

Donald R. Nelson, third from left, receives his fifth-place \$600 Elks National Foundation Award from P.E.R. John F. Lynch, Chairman of the Mass. Elks Youth Activities Committee, at ceremonies at the home of Milton Lodge, the young man's sponsor. Looking on approvingly are State Pres. Michael J. McNamara, left, and E.R. E. A. Bagnulo.



On behalf of Bartlesville, Okla., Lodge, P.E.R. M. M. Moore presents the title to the Panel Rescue Squad Truck, partially shown here, to Fire Chief Walter Crowder. Equipped with a respirator and other life-saving devices, the truck has already served on several rescue missions, notably in connection with tornado-hit Blackwell, Okla.



Shortly before his death, Clark C. Griffith, owner of the Washington Senators, third from left, was made an Honorary Life Member of Washington, D. C., Lodge at a ceremony marking his 30th year as an Elk when he also received a scroll citing his splendid contributions, as a citizen, to the youth of the community. Making the presentation is E.R. R. C. Gilpatrick. At left is Est. Loyal Knight W. H. T. Belt and at right is Est. Lead. Knight J. P. Gamble.



The 73-year-old steam pumper of the Narragansett Fire Dept. was a big attraction at the annual South Kingstown, R. I., Lodge clambake. The ancient engine, in perfect working order, has been retired from service to be used very successfully in preparing the seafood for clambakes, as 275 South Kingstown Elks can testify. At left E.R. Everett R. Sykes looks on as Co-Chairman George Raitano checks the steam pressure. At right is Fred Folcarelli, assistant chef.

1932 he was elected Grand Esteemed Loyal Knight and in 1942 he again served as District Deputy. In 1945 he was appointed to the Grand Lodge Antlers Council, later serving on the Grand Lodge Auditing Committee. He was a member of the Grand Lodge Credentials Committee from 1950 until this year.

A native of Columbia, and a city employe for more than 40 years, he was Director of the City's Park and Recreation Department at the time of his passing. A veteran of World War I, Mr. Harth had directed his Elk activities in recent years mainly in the interests of our servicemen. As State Chairman of

the Elks Service Commission, he achieved great benefits for the members of our Armed Forces stationed in his State, and for the veterans who are hospitalized there.

Mr. Harth, whose only son was killed in action during the second World War, is survived by his wife, daughter and three grandchildren whose sense of loss is shared by all who knew him.

#### Hickory Elks Send Boys to No. Car. Camp

The membes of Hickory Lodge No. 1654 established a new record this summer by sponsoring 87 deserving boys on a two-week stay at the No. Car. Elks

Camp. Two Trailways Buses brought the youngsters to the Hendersonville spot this year, under personal escort of a large group of interested sponsors.

A favorite undertaking of No. 1654, the screening of 300 boys recommended by religious and educational leaders, the Salvation Army and other groups requires much time and effort on the part of the Hickory Elks. However, they do the job willingly, well repaid by the splendid results found in the boys' outlook and character after their vacation at this well-run camp where they find clean living, good sportsmanship and an awareness of God through daily religious services.



Smashing all records for the district, Hickory Lodge sponsored a two-week vacation at the outstanding North Carolina Elks Camp for 87

youngsters who made the trip under Elk escort in two chartered, air-conditioned Trailways Buses. En route, the boys stopped for a picnic.

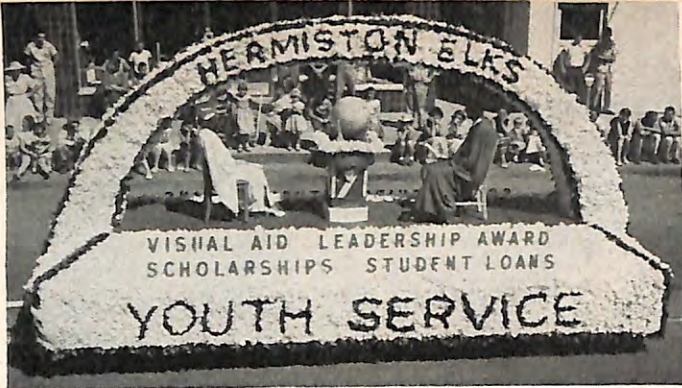

Telling its own story of Elk Service to Youth is the prize-winning float entered by Hermiston, Ore., Lodge in the Pendleton Round-Up in which it won first honors in the fraternal section, and the Umatilla County Fair parade in which it captured second place.



Asheville, N. C., Lodge's Annual Orphans' Day Picnic found several hundred children from various orphanages enjoying an all-day program of wholesome recreation. With Eugene S. Holcombe as Chairman, the Elks and their ladies served a healthy picnic lunch to the young guests.



E.R. T. Robert Thune hands South Bend, Ind., Lodge's \$3,500 check to Chairman Thomas Burke of the Ind. Elks Cancer Research Committee, right. Looking on are the lodge's Fund Drive Chairman L. C. Gerber, left, and State Pres. Herbert Beitz. The South Bend Elks also gave a \$500 check to the St. Joseph County Cancer Committee.



When D.D. John R. Hauser, third from left foreground, visited Sayre, Pa., Lodge, he was photographed with E.R. L. E. Canavan on his left, other lodge officials and visiting dignitaries including Past State Pres. Barney W. Wentz and N. Y. So. Cent. D.D. Eugene F. Hourihan, third and fifth from left background, respectively.

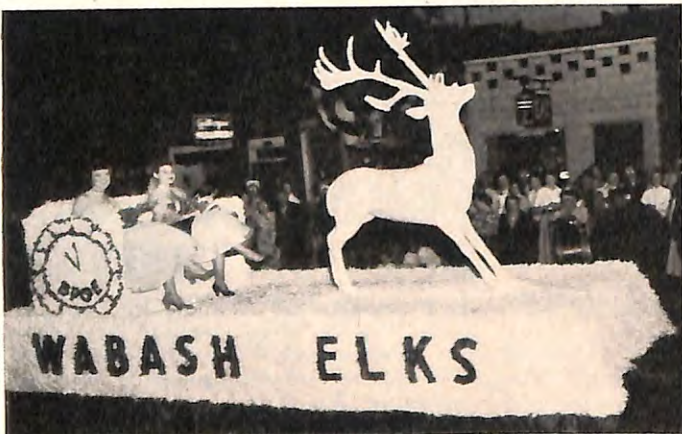

Above: Southern California's newest judges, P.E.R. John W. Allen, left, and Est. Lact. Knight Alfred J. McCourtney, right, with E.R. C. B. Ellison when their fellow Lancaster Elks paid them tribute.

Left: When Wabash, Ind., celebrated its 75th anniversary as the "first electrically lighted city in the world," two parades found this beautiful float, entered by the local Elks, awarded second-place honors.



Above: Photographed with some of the trophies awarded in the 8th Annual Golf Tournament, held at Ticonderoga, N. Y., between lodges of the North and Northeast Districts of the State are, left to right: Past Pres. Dr. J. M. Alverson of Glens Falls, Honorary Past Pres. and Chairman of the N. Y. State Elks Golfing Committee Lou Adelson and Pres. John Clancy, both of Schenectady Lodge which was the tourney's low gross winner with a four-man total of 305. Ticonderoga followed with 319, and Massena with 330.

Below: In a recent fund drive, Baltimore, Md., Lodge realized more than \$13,000 for its charitable endeavors. Photographed with the check are, left to right: P.E.R. Joseph L. Manning, Fund Drive Chairman; E.R. Joseph F. Wacławski, and Fund Treas. O. F. Murphy.



Above: To help fight the Massachusetts polio epidemic, Lowell Lodge presented a Chestpirator to the General Hospital. Left to right: P.E.R. and Secy. F. V. Redding, E.R. H. A. Kierce, Dr. R. S. Gilmore, Chairman of the Hospital's Doctor's Polio Committee, Treas. J. R. Harrington and Mrs. Ralph Tweed, R.N.



# *A Message from the Grand Exalted Ruler*



## PLAN ELKDOM'S PROGRESS

WHENEVER our country needs anything, the Elks pitch in and provide it. Recent years have brought a tremendous increase in the need of youth work, and our Order has responded with action as always. Under the leadership of the Grand Lodge Youth Activities Committee, Lodges and State Associations have greatly expanded their youth-serving programs. These will pay rich dividends in the years to come.

The Youth Activities Committee recently distributed its program for the year, in which it made many sound suggestions for the development of youth activities by our lodges and State Associations. I hope that these ideas will be put to practical use. There simply is no better way to serve our community and our country than a well-planned, constructive youth program that helps to build good, solid, American character in our youngsters. Find out what your community's needs are, determine what kind of a program is needed, then get your lodge solidly behind it and you'll find that there is nothing like a sound youth program for developing enthusiastic cooperation among your members.

Certainly every Elks lodge should participate in the two major projects of our Grand Lodge Youth Program—the Elks National Youth Leadership Contest and Elks National Youth Day. Through the Leadership Contest, our Order gives deserved recognition locally, in each state and nationally, to the boys and girls who have distinguished themselves as leaders among their own associates. We are encouraging youth to develop their talents for leadership in a democratic society.

Again this year, May 1 will be observed throughout our Order as Elks National Youth Day, when we pay tribute to our boys and girls for their accomplishments as junior citizens. The acts of a few unhappy youngsters tend to stigmatize a whole generation as juvenile delinquents. Elks National Youth Day puts the problem in proper focus by demonstrating that the overwhelming majority of our boys

and girls are decent, earnest, law-abiding, patriotic and God-fearing. Now is the time to start planning your lodge's program for Elks Youth Day May 1. Make it a significant event that will command the respect and support of your community.



Our Membership Control Program, for the reduction of lapsation and to realize a five per cent gain in membership, is forging ahead on both fronts. For the first time in years, many lodges have taken a critical look at their dues collection methods and lapsation problem, and are really doing something about it. This is going to result in a healthy improvement in dues payment.

Lodges in every state will honor their State Elks Association President in January by initiating classes dedicated to these able leaders of Elkdom. I hope that every lodge will initiate a substantial number of candidates, carefully selected, as always, of course, so that the class will be the splendid tribute that it ought to be.



Fittingly, the Grand Lodge Committee on Lodge Activities has asked our lodges to devote a day in December to a fund-raising activity for the Elks National Foundation. In this Christmas season, how better can we recognize its significance than with our gifts of money that will enable our own wonderful benevolence agency better to manifest to all mankind the love that He, whose birth we celebrate, taught us to have in our hearts always. This is the season of giving. Let us give first to the Foundation.



To all of my Brothers, and to their families, I extend the wish that the peace and happiness, which are the promise of this Holy Christmastide, be yours in joyous abundance.

*John L. Walker*  
GRAND EXALTED RULER

*"The youngsters of this country are fine and good. If there are any bad boys or girls it is because some adult failed to do his duty".  
Serve Elkdom—Live Elkdom*



woods



# The Elks and the Boy Scouts

BY COMMANDER THOMAS J. KEANE

WELL, it's the Elks for me, sir."

I admit I was surprised. Not that the young officer to whom I was speaking had mentioned the Elks. I had known the BPOE well and favorably for many, many years. It was the fact that he seemed to me to be too young to join the Elks. All the members of that Order that I knew were rather staid, dignified, successful men who had reached a moderate degree of maturity. I was later to learn that a large portion of the members were not quite so staid, not quite so dignified—yes, quite successful—but certainly not very old.

The war in Europe was just over and I had received my orders to proceed to another command in the South West Pacific. Before leaving I had had a chat with all of my officers—all rather young—who had served with great devotion and efficiency as members of the staff of my naval command in Europe.

I was asking each one what he intended doing when he returned to the United States. I was suggesting some of the organizations that they might join, such as the American Legion, Veterans of Foreign Wars, perhaps one of the service clubs, like the Junior Chamber of Commerce. Most of them seemed to be impressed with what I suggested and stated that it was their intention to join one of the groups of which I had spoken.

But the young officer, who by the way was one of my favorites, and one of the best, was very positive that the only organization that he was going to join was the Elks.

I thought it would be interesting to find out why he wanted to join the Elks, rather than any of the others, and asked him.

"Well, sir," he said, "my family lived on 'the other side of the tracks' and I had a tough time when I was a kid. When I was twelve I was asked to join

the Boy Scouts. My crowd did not think much of the Scouts, but a friend of my father's brought me to a meeting one night. Very much to my surprise I liked it, came back again and finally joined the troop. After three years I had become an Eagle Scout, the highest rank in Scouting. Now as I look back on it I know that what I learned in that troop changed the whole course of my life. It was only after I had been in the troop for over a year that I realized that there would be no troop in that part of town if it weren't for the Elks Lodge that sponsored it.

"Well, sir," he continued, "I want to join the Elks. There are many reasons why I want to, but I admit that way down in the bottom of my heart I hope to be able to help some other kid, who 'lives across the tracks.' I figure I can do that by being a member of an Elks Lodge."

Since then I have often wondered whether the Elks Lodge that sponsored the troop to which this young man belonged ever fully realized what a grand thing they had done for him and for the community to which he belonged—and will belong!

When the war in Europe was over I was transferred to the South West Pacific theatre where I was stationed until after the defeat of the Japanese. From there I returned home to the United States where I arrived safe and sound after five years of very active service abroad.

During the eight years since the end of the war I have learned a lot about the Benevolent and Protective Order of Elks.

In the spring of 1947 I attended a meeting at which were present five Past Grand Exalted Rulers of the Elks, who were discussing with the National Officials of the Boy Scouts of America ways and means by which they could be of help to more boys throughout the

(Continued on page 44)



Commander Thomas J. Keane is one of the few remaining pioneers of the Scout Movement. He was a close associate and advisor of Dr. James E. West, first Chief Scout Executive of the Boy Scouts of America. He developed, organized and promoted the first successful Sea Scout program in America and was the first National Director of Sea Scouting. He was the first National Director of Senior Scouting, first National Director of Civic Relationships and was an officer in the Navy during World War I. On being recalled to duty in World War II, he was placed in command of Naval operations in Belfast, Northern Ireland. After thirty-seven years' service in the Naval Reserve and thirty-four years in Scouting he is now retired, and is devoting his time to speaking and writing on Scouting and Americanism.

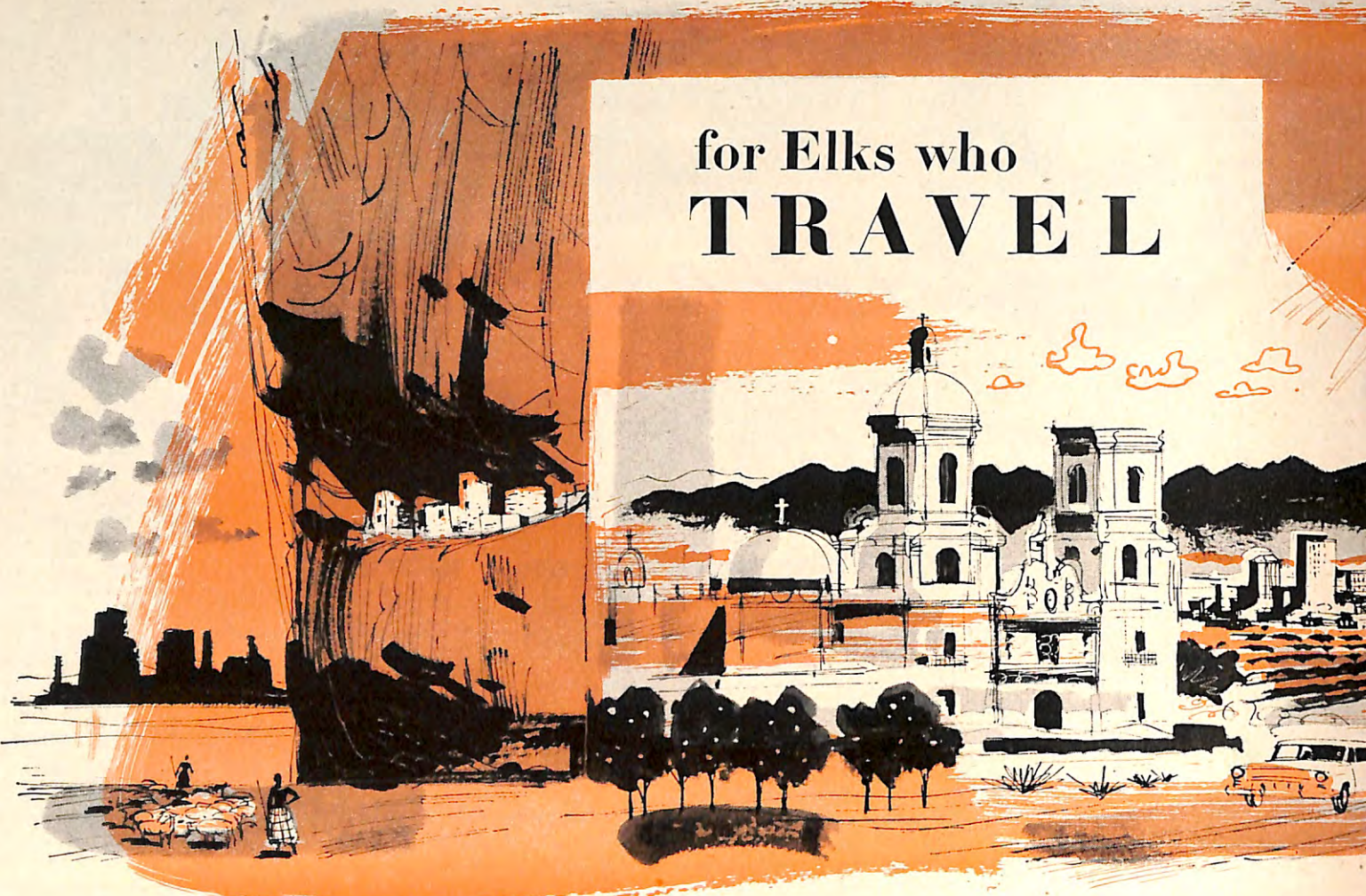

## for Elks who **TRAVEL**

BY HORACE SUTTON

**Arizona has 230 clear days a year now—yet they say it used to be at the North Pole.**

A BUNCH OF BRITISH scientists came up with the notion not long ago that, of all places, the North Pole was once located in Arizona, now a land replete with cactus, desert, sun, swimming pools, and tourists. This North Pole business was supposed to have been the case something like 600 million years ago and, to be sure, Arizona has had plenty of time to thaw out since. Today the sun is said, by usually reliable sources, to shine 86 per cent of all the time it possibly could. There are some 230 clear days a year and the mean monthly temperature, which really isn't very mean at all, comes to 70.3 degrees. Since the flowers and the tourists bloom all winter long the living is easy and outdoorsy. Almost every motel has its own patio and swimming pool. Some are even equipped with stables.

Before the war the Southwest was largely a playground for the rich and indolent, but lately the Valley of the Sun area, in the general vicinity of Phoenix,

has been spending roughly \$2 million a year on new accommodations. Whereas the pre-war places are still on hand and ready and able to relieve you of \$80 a day for a suite (meals included, of course), you can now find a modern, cheerful, attractive motel for the likes of \$8 a day without food. There are a variety of good restaurants both in the towns like Phoenix, Scottsdale and Tucson and also tucked away in the surrounding hills.

In terms of air travel, the Southwest is two hours from Los Angeles, seven hours from Chicago and the mid-west and a bit less than eleven hours from the east. Trans World Airlines, which descends at Phoenix, points out that most ranches will arrange to pick you up and deliver you back to the airport at no extra charge, an added inducement since most of them are salted away in the foothills. As for prices in the top of the season, which runs from February to mid-April, the Kay-El-Bar Ranch at Wicken-

burg, a town which seems to be world ranch headquarters, would run about \$15 a day or \$105 for a week in the sun plus air fare back and forth—or train if you prefer. This tariff includes room, bath, meals, horseback riding over the desert trails, a cowboy to guide you, swimming in the pool, square dances at night, chuck wagon picnics off in the desert, and such unlikely endeavors as panning for gold.

If there should come a time this winter when the wind whistles and the bones creak, but there just isn't time for a full-fledged vacation, you might consider with some appreciation a four-day weekend provided by the Arizona Manor Hotel. From January 10 to April 15 the four-day hiatus for each of two persons comes to \$33.50, a fee which takes in a room and bath, transportation back and forth from the airport, but no meals. Between November and January the tariff for the same operation is \$21.50.

American Airlines, in association with Avis rent-a-car System, have organized a package tour of Arizona including a taste of ranch life, a look at the Grand Canyon, and overnights in the west's best motels. Here is how it works: You fly to Phoenix and there pick up your rental car at the airport. It is a short drive to



ILLUSTRATED BY TOM HILL

the Western Village Motel, a drive-in that looks like a western village, although somewhat plusher than the pioneers had it. On the second day you buzz out of Phoenix via Route 89 through Wittman and Morristown arriving at Wickenburg. Once it was a mining town and indeed they still weigh ore in the general store, but now it is also, as I have indicated, the headquarters for dude ranching, an endeavor that has become almost as profitable as mining.

You leave 89 beyond Prescott in favor of Alternate 89 through Clarksdale and from there make the side trip to Montezuma Castle National Monument where you can see the Pueblo cliff dwellings preserved from prehistory. The suggested route then is to take in Oak Creek Canyon with its steep and colorful walls rising 1,500 feet above the valley. You can put in overnight at El Rancho Motel at Flagstaff.

The third day will take you north on 89 to Cameron, then east on 64 to Grand Canyon National Park. There ought to be plenty of time to drive along the rim. After a good look at the tremendous rent in the earth's surface, you can head back in the afternoon stopping that night at the Sea Shell Motel in Holbrook. If you're up early the next morning take off

for the Painted Desert, a mix of mesas and buttes, then south to the Petrified Forest. Beyond is the Salt River Canyon which will take you to Globe, Arizona's biggest copper lode. You'll be back in Phoenix in the evening and back abed in the Western Village Motel.

On the fifth and final day you can drive right to the airport, leave your car and climb aboard the plane for the trip back home. The tour price for two persons in a room comes to \$59 per person—three in a room, \$41 per person. This tab includes the use of the automobile for five days, a maximum of 700 miles of driving and gas, oil, and insurance, lodging at Western Village Motel in Phoenix for two nights, the first and the last, and two nights lodging on the road. The air fare round trip from New York is \$265.90, from Chicago, \$182.10, from Dallas, \$110.10.

There is much to be said, too, for the Tucson area, farther south, just sixty-five miles from the Mexican border. Four flags have flown over Tucson—Spanish, Mexican, the U.S., and the Confederate. Some mysterious types who lived without flags inhabited the place before our civilization began, but later it became the home of the Papago and Apache Indians. The Spaniards came looking for gold and

1 Double room  
2 Full breakfast  
3 Baggage handling  
all for \$5.50 per day per person double occ.

Near Radio City  
in the heart of  
NEW YORK

HOTEL

BRISTOL

129 WEST 48 ST., N.Y.C.  
T. E. SNODGRASS, MGR.

*A Good Place to Know*  
**Rochester, Minn.  
No. 1091**

You'll find Rochester, Minnesota Lodge a comfortable and friendly stopping off place when in our part of Minnesota.

Finest liquors and excellent beer and other items for your pleasure. We do not have rooms for overnight stay nor do we serve meals but our Lodge is conveniently located only two blocks from downtown Rochester and well within walking distance of the leading hotels and good restaurants. Stop off for a friendly visit. We aim to please you.



**HEADING FOR THE  
JERSEY SHORE?**

While on the way stop and relax

at  
**MILLVILLE, N. J., B. P. O. ELKS**

Here is the Gateway City to most South Jersey Coastal resorts. You'll find Millville No. 580 a restful place to linger awhile. No overnight accommodations in the Lodge but you can get tasty snacks and a refreshing shower. There's a powder room too and grill and recreation rooms plus a sumptuous lounge. Cocktail hour Monday through Saturday 4:30 to 6:30 P.M. Your welcome here will be cordial and we'll try to make your journey a happier one.

were eager, as well, to establish missions. One of the most beautiful is the Mission of San Xavier del Bac, ten minutes from the center of town. American Airlines sets down in Tucson, now a modern city of some 26 first class hotel and guest accommodations.

Sun and dry air is the atmosphere of Tucson, and visitors can just lie and bake at the poolside or ride the Indian trails in the shadow of the mountains. Mount Lemmon, as a prime example, growing 9,000 feet high out of the pines of Coronado National Forest. The Saguaro Ski Club practices on the slopes. On saner levels there are Indians selling handicraft and smart shops selling Indian handicraft, and every assortment of exercise from golf to rodeos.

# News of the State Associations



Horace R. Wisely, left, Secretary of the Board of Grand Trustees and Vice-Chairman of the California Elks Major Project Committee, and Committee Chairman C. P. Hebenstreit, right, pose with a mammoth poster of little Dickie Swarner, one of the 350 cerebral-palsied children the California Elks aided during the past year. The child thrilled thousands of his benefactors by discarding these heavy leg braces for a tricycle during the recent Convention of the Elks of that State.

## BANNER YEAR REVIEWED BY CALIFORNIA ELKDOM

Four days of intense activity, highlighted by the presence of Grand Exalted Ruler John L. Walker and his wife, kept nearly 10,000 Elks and their ladies on the go during the 41st Annual Convention of the California Elks Association. Attendance never flagged for a moment during the smoothly handled sessions, with large and attentive audiences on hand at all times.

Opened by retiring Pres. Robert P. Mohrbacker on Oct. 6th, the first business session was held in the handsome new home of San Diego Elksdom, with those present privileged to hear one of Mr. Walker's eloquently dynamic talks, following his introduction by Past Grand Exalted Ruler L. A. Lewis. Another former leader of the Order, Dr. Robert South Barrett, spoke briefly at this session and made the principal address at the banquet honoring Mr. Mohrbacker that evening.

Both distinguished speakers stressed the outstanding accomplishments of the California Elks Major Project which aided 350 cerebral palsy victims during the past year. This work was the main topic under consideration at the Friday morning business session, when Chairman C. P. Hebenstreit read his Committee's

proud report before a crowd estimated at 3,000. The magnificent achievements of the 14 therapists who operate the Project's mobile units throughout the State, and who were introduced at this gathering, were dramatized by the presence of seven-year-old Dickie Swarner who pedaled his tricycle around the theater's stage—no longer forced to wear his cumbersome leg braces, thanks to the Elk-sponsored therapy he has received.

At the conclusion of the report, during which all members of the Committee were presented, donations totaling \$108,000 for this work, realized through the famous Piggy Bank activity, were made by representatives of California's 117 lodges, with Palo Alto Lodge's \$12,921.82 the largest single donation. On this occasion, Long Beach Elksdom turned over to the Major Project Committee a fully-equipped \$2,400 station wagon and a cash gift of \$2,600 as a tribute to retiring Pres. Mohrbacker, a P.E.R. of that lodge.

### FORTHCOMING STATE ASSOCIATION MEETINGS

Washington	Port Angeles	Jan. 13-14
Oregon	Corvallis	Jan. 14
South Carolina	Sumter	Jan. 19-20
Michigan	Jackson	Jan. 21-22
Montana	Red Lodge	Jan. 28-29

The California Elks' Veterans Service Committee report was also delivered at this meeting by its capable Chairman Robert N. Traver. The session came to a close with an impressively sensitive Memorial Service at which Past State Pres. Edward A. Keller presided, P.D.D. Russell Waite delivered the address and the Assn.'s long-time Chaplain, Rev. D. Todd Gillmor offered the prayers. The Eleven O'Clock Toast was delivered by Past Grand Exalted Ruler Lewis, and a pleasing musical background was provided by the Grossmont Red Robe Choir.

A memorable feature of the conclave was the Eighth Annual Festival of Music in which eight Elk Glee Clubs appeared singly and in combined choral arrangements, with several operatic solos by Miss Dolores Davis. This program took place at the Balboa Bowl, scene of the Drill Team competition which saw top honors go to Inglewood in Class "A" and Alhambra in Class "B."

Mr. Lewis handled the installation of the officers who will serve until the 1956 Convention at San Jose. Led by James B. Nielsen of Watsonville as President, they are Treas. Robert Walker, Santa Ana; Secy. Edgar W. Dale, Richmond; Chaplain Rev. David Todd Gillmor, San Jose; Vice-Presidents Martin Green, Blythe; Ridley Smith, Santa Ana; Vern Huck, Los Angeles; A. Carl Dwire, Oxnard; John Morris, Palo Alto; John Kidd, Merced; Charles Aiman, Walnut Creek, and Robert Brooks, Alturas; Trustees Albert Raymond, Anaheim; Carroll Nordquist, Pasadena; Paul Sanchez, Santa Maria, and Charles Reynolds, Vallejo.

Concise, well-phrased reports outlined the steady progress of California Elksdom which enjoyed a net increase in membership of 4,000 candidates in the past year with seven lodges instituted. Charitable expenditures totaled more than \$672,000 with the lodges' cash and bond assets audited at well over \$200,000.

California's youth activities were at a high level during the past 12-month period, with 297 applications for Elks National Foundation Scholarships received and a total of 11 girls and 11 boys rewarded. The sponsorship of 145 athletic groups by the lodges found the junior baseball teams in the favored position. The Elks of this State are responsible for 191 Boy Scout units, in addition to Girl Scout, Campfire and Boys State groups. Youth Leadership Contest participation continues to increase in popularity in the Gold Coast State. During the Convention at which Arizona State Pres. Kenneth Crowder, Ariz. No. D.D. Duncan G. Graham and Past Grand Est. Lead. Knight M. H. Starkweather of Tucson were guests,

many competitions were held, with El Centro capturing the Ritualistic title over Sonora. Long Beach Lodge won the softball tournament and San Bernardino's sharpshooters took the pistol match. A record 800 Elks entered the three-day handicap bowling tournament played at two San Diego bowling centers. Los Angeles took home the team trophy while Oxnard Elk Walt Dailey was named undisputed singles champion. Wally Temple and Bud McCurdy of Whittier paired up for a win at the Hillcrest Alleys, and Walt Peale and Matt Soares of San Pedro took the doubles at the Tower Recreation Center.

A parade depicting California's history and witnessed by 75,000 persons brought the enthusiastic conclave to a close on a gala note. Led by the Marine Corps Recruiting Depot Band, the pageant's hundreds of marching units and 29 musical contingents, including many youth bands and divided into eight sections, took nearly three hours to pass.

### ALASKA ELKS VOTE FOR C-P MOBILE UNITS

Perhaps the most important decision reached by the delegates to the 8th Annual Alaska Territorial Elks Assn. Convention at Seward Oct. 6th, 7th, and 8th, was the one which authorized the use of mobile units, similar to those utilized in California and other States, in connection with their Cerebral Palsy Program. It is the Alaska Elks' intention to have the first unit on the road by next month, operating in the western section of Alaska in which a number of cities and rural communities can be reached by road. Additional equipment, which can be transported by the therapist to those areas of the territory accessible only by air, will also be purchased.

Highlight of the Convention was the presentation, by an authorized representative, of each lodge's contribution to the Cerebral Palsy Fund which, for the second year, reached a figure of more than \$32,000. The donation was accepted by Robert D. Lewis, Chairman of the Cerebral Palsy Commission.

In attendance with the Order's new Grand Tiler, M. E. Monagle of Juneau,

for the express purpose of aiding the Association to establish firmly this Major Project were Chairman Edwin J. Alexander of the Lodge Activities Committee of the Grand Lodge and F. George Warren, Vice-President of the Washington Elks Assn. which has made such great strides in a similar effort.

In addition to a parade on the 6th, in which most of the lodges represented participated, many pleasant social activities were enjoyed, and there was a splendid attendance at the Memorial Services on Saturday morning, which were open to the public.

Grand Tiler Monagle was elected President of this organization which will meet next October at Juneau. Other officers are James Nolan of Wrangell, and Vincent W. Root of Kodiak, Vice-Presidents; Matt Onkka of Palmer, Quentin DeBoer of Petersburg, and Hollis Heinrichs of Cordova, Trustees; Richard W. Smith, Anchorage, Secy.-Treas., and Norval Kane, Anchorage, Historian.

### BIGGEST CONVENTION IN COLORADO ELK HISTORY

Registration for the four-day 1955 Convention of the Colorado Elks Assn. at Grand Junction topped 1,900, to make it the best attended in Association history.

Special guests at the late September 52nd Annual Meeting were Grand Exalted Ruler John L. Walker, and Past Grand Exalted Ruler Floyd E. Thompson who gave a fine address at the opening ceremonies.

During the final session, the delegates made a \$10,000 donation to aid retarded



Raymond Riede, left, P.E.R. of Denver Lodge and Past Pres. of the Colorado Elks Assn., hands his personal check for \$1,000 for the Elks National Foundation to Past Grand Exalted Ruler Floyd E. Thompson. The presentation took place during the Colorado Elks Convention.

children; the money will help support Elks Laradon Hall at Denver, an outstanding Colorado Elk project. John Godec, Jr., Chairman of the Hall Committee, reported that the Elks of his State had contributed nearly \$30,000 to this fine school during the past year.

In the same period, it was revealed by State Charity and Welfare Committee Chairman J. Walter Socha, these generous 29,062 Elks had turned over \$205,778.66 to charity and welfare—a per capita representation of \$7.08.

Loveland Lodge which will be host to the 1956 Convention next September won the State Ritualistic Contest in which 14 teams participated. Pueblo Elksdom took second place, over the defending championship team from Greeley. Grand Junction and Colorado Springs entries followed in that order.

Donald L. Johnson of Montrose succeeds H. G. Downs as President of the Assn. Other officers are Robert L. Barth, Brighton, 1st Vice-Pres.; Byron A. Anderson, Denver, 2nd Vice-Pres.; Frank H. Buskirk, Montrose, Secy.; Eugene M. Welch, Grand Junction, Treas.; F. Eugene Crawford, Canon City, five-year Trustee; C. B. Millen, Brighton, Chaplain; Robert H. Allen, Creede, Sgt.-at-Arms; G. J. Morgan, Loveland, Tiler.

### COOPERATIVE JANUARY CLASS

The Lodge Activities and the State Associations Committees of the Grand Lodge have joined forces in working toward a really outstanding initiatory tribute to the Order's State Association Presidents during the month of January.

All lodges should do their utmost to make each State President's Class one which truly reflects their appreciation of his work for Elksdom in their State.

Alaska lodges give \$32,000 to their Cerebral Palsy Fund. Left to right: Grand Tiler and new Assn. Pres. M. E. Monagle, Trustee Quentin DeBoer, D.D. Orville Paxton, Fairbanks E.R. E. P. McCarron, Juneau E.R. R. O. Faulkner, retiring Pres. Orval Thurman, C-P Commission Chairman R. D. Lewis, Kodiak E.R. John Gibbons, Palmer E.R. Russell Felzien, Seward E.R. Delmar Zentmire, Anchorage E.R. R. B. Smith; Grand Lodge Committee on Lodge Activities Chairman E. J. Alexander.





San Juan, Puerto Rico, Lodge's officers and the 14 men they initiated last September.



Officiating at the dedication of the \$350,000 home of Newton, Kans., Lodge were, left to right, seated, former Grand Lodge Committeemen C. E. Klein and F. H. Kelly, Past Grand Exalted Ruler Henry C. Warner, D.D. C. L. Bishop, State Pres. F. T. Pucka and P.D.D. T. H. Lowman; standing: P.D.D. Clay Hedrick, R. M. Green of the Grand Lodge Credentials Committee, P.D.D. C. L. Gray, Building Committee Chairman C. K. Suderman and D.D. N. E. Gustafson.



Springfield, Mass., Lodge's Youth Activities Committeemen A. F. Santinelli, Chairman Kenneth Hanks, G. W. LaFleur and G. A. Shannon, left to right, with the stencil through which the admonition it offers was applied to the sidewalks at every exit of some 66 schools in the area. This practice was adopted this year by the Committee to augment its fine School Safety Program.

### Houston Host to Texas Southeast Elks

Representatives of all but one of the lodges of Southeast Texas were in Houston for the meeting called by State Vice-Pres. Ed. F. Burgdorf in conjunction with the Clinic conducted by D.D. G. M. Brassard.

State Pres. E. C. Bunch outlined his plans for the year, following which other State Association work was discussed.

At the conclusion of the session, a supper and floor show were enjoyed.

### Top Links Aces on Terre Haute, Ind., Elk Green

When Terre Haute Lodge No. 86 held its 11th Annual "Coon Hunt" at the Elks Fort Harrison Country Club, the highlight of the affair was a golf exhibition put on by two of the Nation's greatest players. Dr. Cary Middlecoff, well-known Memphis dentist who captured the 1955 Masters Tournament at Augusta paired off with local golf star Warren Artz, and Julius Boros, erstwhile National Open title-holder and winner of the rich "All American" tourney at the Tam-O-Shanter Club in Chicago last summer, teamed up with Gene Verostko, Terre Haute's match-play titlist.

The match, which lasted only five holes before a downpour stopped operations drew a crowd of 3,000 and followed a golf clinic during which the two greens giants displayed their artistry.

General Chairman for the entire event, an all-day affair which attracted over 5,000 to the club and is held annually for the benefit of the Elks charity program, was P.E.R. Dr. Glenn D. Irwin, with E.R. Dr. Merle Drew supervising the proceedings. Dr. Middlecoff had his Manager, Early Maxwell, with him and Boros was accompanied by Arthur Witzleben, representing his sponsor, the George S. May Company of Chicago.

All were luncheon guests of the Elks and the Terre Haute Chamber of Commerce, whose Pres., Elk Joseph Quinn, was also on hand.

Right: At the Terre Haute, Ind., Elks' Fort Harrison Country Club during their 11th Annual "Coon Hunt," left to right, standing: Warren Artz, City Medal Play Champion; A. H. Witzleben; Julius Boros, winner of the 1955 All-American Tournament at the Tam-O-Shanter Club; Dr. Cary Middlecoff, 1955 Augusta Masters Tourney winner, and Terre Haute's 1955 match-play titlist Gene Verostko. Seated are James Wolfe and Paul Mascari, and, standing, Bill Blaiklie.



Left: Ontario, Calif., Lodge's celebration of Constitution Day is marked by the presentation of historical documents to three local high schools. Left to right: Chaffey High School Principal Ernest A. Payne; P.E.R. Oris F. Heinauer who instigated the program in his State; Col. C. R. Crusan, the lodge's Americanization Chairman; David Meriam, Pres. of the Chaffey Student Body; E.R. Rolla Moore; Secy. C. T. Johns.







When the Chicago White Sox played the Boston Red Sox at Fenway Park in Boston, the Elks of Massachusetts paid tribute to the visiting pitching ace, Dick Donovan, a member of Quincy, Mass., Lodge. Pictured with the "Quincy's Dick Donovan Day" tags distributed at the game are, left to right, State Assn. Pres. Michael J. McNamara, Hobart K. Robinson, a prominent Quincy sportsman, and P.E.R. George C. Fay of Quincy Lodge, Co-Chairman of the well-attended program.



Practically everyone has done something to help the flood victims in the Northeast, including the Elks of Norwich, Conn., one of whom was Earl B. Whitehead, pictured curb-side, in the clown make-up he wore in his march from Norwich to Putnam, with his dog Fuzzy, collecting funds for the flood sufferers there. When he arrived Mr. Whitehead was able to present nearly \$185 to Putnam Lodge's E.R. Glenn C. Mauer. It took Mr. Whitehead ten hours to make the 36-mile trip, carrying his slit-sealed collection bucket.

### Springfield, Mass., Elks Enlarge Safety Program

The Youth Activities Committee of Springfield Lodge No. 61 did an outstanding job last year in the distribution of School Safety Stickers.

This year, the group not only distributed 2,500 car-bumper stickers reading: "School Is Open, Drive Carefully," but interested other lodges to emulate the program, resulting in the placement of 6,500 additional stickers.

Their own program was enlarged this year by the addition of pavement signs reminding the children at 66 schools to STOP, LOOK and WALK.

## THE BUSIEST BUILDING IN WINSTED



**T**HERE IS PROBABLY more neighborliness per square foot in Winsted, Conn., than in any other town in the country—and a lot of it is just inside these doors.

The hardest-hit community in the Northeastern flood area, Winsted has learned the meaning of cooperation, with the Elks at the top of the class.

Their building was one of the few spared when the raging Mad River swept death and havoc along its path. No sooner had the flood waters receded than Exalted Ruler John W. Winn ordered the facilities of the building to be placed at the disposal of Army personnel called in to enforce military law. The officers bunked in the guest room, the enlisted men in the lodge room. When they left, Army engineers moved in while they erected Bailey bridges in town.

Hundreds of men were brought to Winsted by the power and telephone companies. Since no recreational facilities were available, they were invited to spend their leisure hours at the lodge building. Gratefully they enjoyed warm fellowship and hospitality during their stay.

As the town began to rebuild, local merchants whose stores had been wiped out looked around for

temporary locations. What happened? Elkdom opened its doors and Main Street moved in.

A United Cigar Company agency set up operations in the foyer; not far away three barber chairs were installed and Michael Adamo, Salvatore Santoro and Salvo Paxcia, owners of the West End Barber-shop who had lost everything but their skill, are keeping the townsmen well groomed under the shadow of the antlers.

Inside the lodge room are the racks of Smith's Men's Shop run by Cy Hamilton, and of the Modern Dress Shop whose merchandise is handled by Mrs. Frances Leshay for her son Bernard while he assists in rebuilding his gutted Main Street store. Maney Leshay, her husband, was one of two Winsted Elks who perished in the flood.

Just a few feet away is the temporary home of Sexauer Jewelers, and operating in the basement is Winsted Motor Sales, Inc., whose stocks and buildings valued at \$200,000 had floated away.

Several of these merchants appear here with E.R. Winn, center foreground, and Mayor P. Francis Hicks, right, a Winsted Elk.

Yes, thanks to the Elks, business in Winsted is going on as usual.



During State Assn. Pres. Franklin J. Fitzpatrick's official visit to Plattsburg, N. Y., Lodge, he was pictured with its officers and a class they initiated in his honor. Seated, third, fourth, fifth, sixth and seventh from left, respectively, are State Vice-Pres. Ralph L. Foote, Past State Pres. Bert Harkness, Mr. Fitzpatrick, E.R. Clyde A. Lewis and D.D. Jack Shea.

1955 - 1956



# YOUTH PROGRAM

GRAND LODGE  
Youth Activities  
Committee

Benevolent  
and Protective  
Order of ELKS  
of the U. S. A.

## An outline of comprehensive program detailed in Youth Committee brochure

state-wide basis will be judged for award on the basis of activity within the State among its lodges. Each State Committee is to submit a digest of its achievements to the Grand Lodge Committee, including activities on a State Association level as well as evidence of promotional accomplishments within the State. This is to be supervised by W. L. Hill, 2317 Fourth Ave., So., Great Falls, Mont., who must have the complete file on each State by May 15th.

### YOUTH LEADERSHIP CONTESTS

Not to be confused with our Scholarship and Most Valuable Student Awards sponsored by the Elks National Foundation, are the Youth Leadership Contests, to be conducted on a local and State level, with the selection of three National Youth Leaders, for both boys and girls, by a special board of judges.

All young people who will be under 19 years of age on July 1st, 1956, are eligible; entry blanks will be made available, on request, by the National Committee which recommends the awarding of worthwhile prizes to the local leaders by each lodge, suggesting U.S. Defense Bonds as most suitable. Through the cooperation of the Elks National Foundation which has allocated to this phase of the Order's work the sum necessary to purchase \$8,500 U.S. Bonds, the Grand Lodge Committee is furnishing substantial awards for the six National Leaders, plus a \$100 Bond to each State winner, to whom the Committee suggests each Association grant additional awards of its own. The National Awards, all larger than in previous years, are a \$1,000 U.S. Bond for each girl and each boy in first place; a \$500 Bond for each girl and each boy in second place, and a \$300 Bond for each girl and each boy in third place.

### ELKS NATIONAL YOUTH DAY

May 1st will once again be devoted to paying tribute to our young people, with special public ceremonies to be sponsored by the lodges at which it is suggested that local youth leaders be honored. Youth Day promotion will be conducted on a contest level, with recognition and awards to those lodges submitting evidence of the best and most constructive program.

State Associations are urged to become active promoters of Youth Day on a state-wide basis, and those which present evidence of the finest promotion will also be recognized and rewarded.

Lodges and State Associations must file their Youth Day reports with Brian M. Jewett, Woolrich, Maine, by May 15th.

### OTHER IMPORTANT DEADLINES

Failure to adhere to the deadlines may disqualify a worthy contender. In addition to those given above

FEBRUARY 15th must see all local Youth Leaders certified to each State Association Youth Committee.

MARCH 10th must see the State Youth Leaders (one boy and one girl) certified to the Grand Lodge Committee.

IN ACCORDANCE with Grand Exalted Ruler John L. Walker's "Plan Elkdom's Progress" Program, Chairman Dewey E. S. Kuhns of the Grand Lodge Youth Activities Committee has well under way a comprehensive and constructive project for the adoption of all lodges and State Associations stressing (1) a well-balanced, year-round youth program (2) outstanding Youth Leadership Contests on local, State and National levels, and (3) the observance of Elks National Youth Day on May 1st, 1956.

Each lodge and State Association has its own Youth Activities Committee led by an interested, capable member, whose names and addresses have been supplied to the Grand Lodge Committee. Mr. Kuhns has sent to each Exalted Ruler, State President and the Chairman of every lodge and State Association Committee a copy of his very complete brochure, a 24-page booklet carrying an introduction by the Grand Exalted Ruler, outlining the year's program and listing the awards, deadlines and other salient information necessary to the conclusion of what promises to be an outstanding year of Elk effort in behalf of our young people.

To coordinate this work, the country has been divided into five sections, and the list of States to be handled by each Committeeman can be found in this brochure.

### AWARDS EXPLAINED

The lodge selected by each State Association as having conducted the best youth program for the year will receive a beautiful plaque carrying a large metal medallion, the Youth Committee insignia, mounted and engraved. That lodge will be the State's entry in the national competition and is a contestant for the National Champion Award—a handsome, engraved trophy which will be presented to the individual lodge winner at the Grand Lodge Convention in Chicago next July.

The judging in the National Champion Contest is to be completed by the Grand Lodge Committee by June 1st. Therefore, the State Associations must have the program on their outstanding lodge in the hands of the Grand Lodge Committeeman Charles C. Bowie, 217 No. Sam Houston Blvd., San Benito, Tex., by May 10th.

In addition to the above awards, the Association which demonstrates the most outstanding Youth Program on a

# The Elks are Pitching—for the Kids

For many years, our lodges have sponsored junior baseball clubs. The tremendous growth in the popularity of this youth activity—represented in this, the first of several, selection of photographs—will be the topic of an article to be published with the opening of the 1956 baseball season.



These young men brought great honor to their sponsors, the Elks of Toms River, N. J., by emerging as undisputed champions of the Babe Ruth League in which the three-year-old lodge has participated in 1954 and 1955.



The Elks of Indiana, Pa., sponsored the 1955 runner-up championship National League team in the community's two-league group of eight.

Left: This group, sponsored by the Elks of Oil City, Pa., as part of their Youth Activities program, are the local Little League Champs.



Acting upon the suggestion of Est. Loyal Knight John Jarvis, Lambertville, N. J., Lodge got together with Somerville, Flemington and Washington Lodges and formed an All-Elks Baseball League which has been tremendously successful. This is the Somerville group with Mgr. Tom Esposito and Coach John Gecik, third and fourth from left foreground.



For the third consecutive year the Little League championship of Norwalk, Conn., was captured by the Elk-sponsored team, pictured above with some of their trophies and, standing third, fourth and fifth from left, respectively, P.E.R. and Mgr. Frank L. Reale, Elk Thomas Maisano, member of the League's Board of Directors, and Coach Richard Millburn.

# Smoke for Pleasure without fear



The modern, "socially acceptable" pipe.

PROVE TO YOUR OWN SATISFACTION WITHOUT RISK

Smoke your KIRSTEN for 10 days. If you don't enjoy a cleaner, cooler smoke, return pipe for full and prompt refund.

Stop worrying about reports on smoking. Use the Kirsten pipe with patented Duralumin "radiator" stem. It's a new scientific approach to safe and clean smoking pleasure. The "radiator" condenses out harmful tobacco liquids. Only cool, dry smoke reaches your mouth.

WRITE FOR FREE 24-page CATALOG—Illustrates a new scientific approach to smoking pleasure. Also Pipes, Cigarette Holders, Tobaccos, Pouches.

ORDER BY MAIL Handsome, durable pipe with light smooth grain Algerian briar bowl. \$7.50 postpaid

**Kirsten** PIPE COMPANY, Inc. Dept. M SEATTLE 7, WASH.

## COLOR PRINTS From Your Color Films

Fast Service—high quality  
KODACHROME, ANSCOCHROME  
EKTACHROME, ANSCO COLOR  
4 x 5 | 5 x 7 | 8 x 10  
50c | \$1 | \$2  
FILM PROCESSED ANSCO EKTACHROME S1  
DUPLICATE 35mm slides, 25c

**25c**  
2 1/4 x 3 1/4

Satisfaction or Your Money Back  
Send for complete price list.  
AUTHORIZED ANSCO COLOR LABORATORY

Minimum order \$1  
No COD's please

**COLORFAX LABORATORIES**  
1160-A Bonifant St., Silver Spring, Maryland

## Spruce ELECTRICAL MANICURIST



For perfect manicures at home

An ideal Christmas gift! Fast, gentle, safe . . . and so easy to use! In less than 10 minutes Spruce gives a beautiful manicure.

It shapes, buffs and cleans nails . . . whisks away excess cuticle . . . makes nails healthier, hands more beautiful. Erases corns and calluses from feet, too.

Ivory color. 4 1/2" high, 5 1/2" dia. Full set of attachments . . . shaper, buffer, cuticle lifter, cuticle brush, callus eraser. Operates on 110 V AC. Guaranteed to satisfy, or full refund. On market since 1938, many thousands in use.

Only \$24.95 complete, factory to you, postage paid anywhere in the world. Or send \$2.00, balance COD.  
ORDER NOW or write for free descriptive literature.

**ABAR MFG. CO.**  
8832 Woodland Ave.,  
CLEVELAND 4, OHIO

Fully Guaranteed  
**\$24.95**

- Nail Shaping
- Cuticle Lifting
- Cuticle Whisking
- Oil Massaging
- Callus Erasing
- Nail Buffing

# Elks FAMILY



**ATOMIC ROCKET LAUNCHER.** What a thrill for a youngster to see and hear rockets zoom from this realistic truck when he loads, locks and fires! Launcher shaft can be raised and lowered and storage compartment is workable. Comes with two harmless rockets. Sturdy, 12" x 5" x 5 3/4". \$2.98 ppd. Mrs. Dorothy Damar, 720 Damar Bldg., Newark 5, N. J.

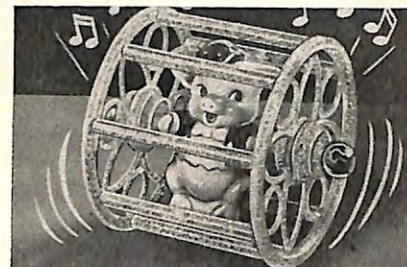

**AND AWAY HE GOES,** but his Jingle Bell toy always rolls back to baby, no matter how hard he pushes him away. And the little piggy always stands right side up! Toddlers are fascinated by the glittering green plastic cage, the jingling bell and the way piggy always comes back. 3" x 4". 94c ppd. Bancrofts, 1112 So. Wabash, Dept. E, Chicago, Ill.

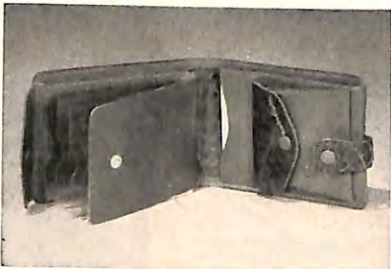

**ALLIGATOR WALLET** for the ladies. Here's genuine alligator and smooth cowhide at a hard-to-believe price. There's a roomy change purse, bill compartment, 4-section plastic pass case and card holder. Snap fasteners hold each section and entire wallet securely closed. In red, green, brown. \$4.95 ppd. Master Leather Crafters, 304 Cherry St., Philadelphia 6, Pa.



**FOR A PROUD ELK** there's no finer gift than this impressive plaque of richly grained walnut and Bronze-finished metal. The Elk's head is cast from a sculpture of a trophy head. Name plate will be engraved with any 3-line inscription. 7 1/2" x 10 1/2", beveled edges. \$19.50 ppd. Emblem Distributing Co., 1153 Lincoln Ave., Dept. E, San Jose, Calif.

Merchandise shown on these pages can be ordered direct from the companies listed. Enclose a check or money order.

## MAGIC FORMULA TREATED



They Smell  
They Bite

## JET ACTION Lures

A magic-like formula treated lure that tantalizes . . . positively will catch all types of pan fish—any time of the year. Used north, south, east and west . . . works thru ice. And the secret Jet Action formula stays on and on! Includes 6 quality hooks, hand tied lures and camouflaged monofilament leaders. The Formula Treated Jet Action way means bait is a thing of the past . . . the smell's the thing! Order today! Only \$2.00 for pack of six. Xmas pack—6 packages for \$10.00.

**TEAR OUT COUPON AND MAIL TODAY!**

**COLEMAN SPORTING GOODS, CO.**  
Buena Park, California

Enclosed is \$.....for.....packages

Name.....

Address.....



## A Bracelet for Grandmother

Send us a list of her beloved grandchildren, first name and birth date, and we'll engrave each on a separate disc. She'll be as pleased as punch to have her whole family with her—for sentiment, for remembrance, and for bragging! Prices include engraving, tax, postage.

In sterling silver.....bracelet.....\$3.00  
each disc.....\$1.50

In 1/20 12K gold-filled.....bracelet.....\$3.00  
each disc.....\$2.00

Write for catalog.  
No C.O.D.'s, please.

*Holiday House*  
2412 Bellevue Theatre Bldg. Upper Montclair, N. J.

# SHOPPER



**YOUR FAVORITE SNAPSHOT** lights up and glows when you have it made into this novel Photo Lamp. Fine for dad's desk, on TV set, or bedside table, the lamp is 12½" high, with picture area 6" x 7". Send print or negative. Picture shows with light on or off. Complete as shown, \$9.95 ppd. Home Shopper, 667 N. Fairfax, Dept. EX, Los Angeles 36, Calif.

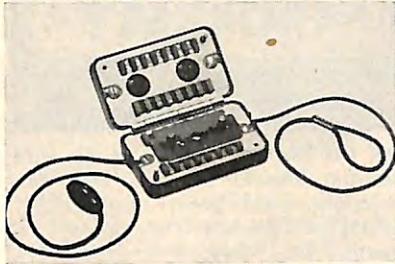

**"SHARP-SHAVER"** Razor Blade Sharpener puts a barber-shop edge on both sides of your double-edge blades in 10 seconds of gentle stroking. It removes those microscopic teeth found on new mass produced blades, giving you smoother, closer shaves—20 to 30 from one blade, \$2.95 ppd. The More Co., 326 Jackson St., Dept. EM, San Francisco 11, Calif.

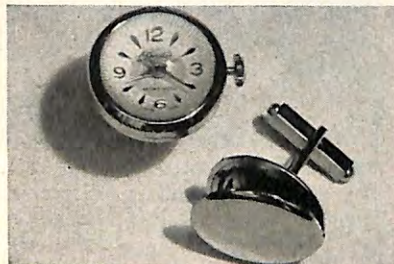

**IT'S ON THE CUFF . . .** this handsome jewelled, shock-resistant Swiss watch that's one of a pair of Imported Cuff Links. The other is a two-picture locket. Gleaming, tarnish-proof golden finish. For man or woman. Year's guarantee. And the price is a surprise: just \$14.95 for the pair ppd. Nassau Importers, 200 W. 34th Street, Dept. E. New York 1, N. Y.

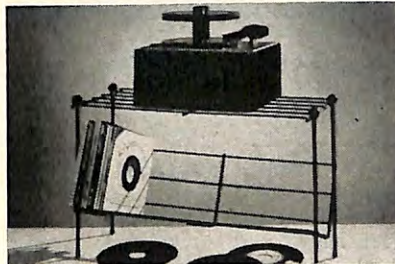

**MAKE A MUSIC CORNER** with compact rack that holds record player or radio, 45 rpm records, tapes, etc. Holds 225 singles or 160 albums. Sockets in corner supports allow you to add racks as your collection grows. Assembled, 22" x 14" x 9", rubber tips. In black iron, \$6.95; brass-plated, \$8.95 ppd. Leslie Creations, Box 9516, Dept. 172, Phila. 49, Pa.

Except for personalized items, there is guaranteed refund on all merchandise returned in good condition within 7 days.

## Relax in Luxury

### DeerMocs

\$8.95

postpaid

MAIL ORDER ONLY

Give men's or women's regular shoe size.



Thick foam rubber insole cushions your foot in comfort.

Send for FREE 40-page Catalog featuring leather shirts, exclusive clothing & equipment for sports and country living.

GENUINE SUNTAN DEERSKIN . . . hand cut by Western leather craftsmen into handsome slippers that mold to your feet for perfect fit. Easy to get on and off, yet hug your feet when you walk. Fold for traveling. Washable! Money-back guarantee.

**Norm Thompson**

Dept. 36 • 1311 N.W. 21st, PORTLAND 9, ORE.

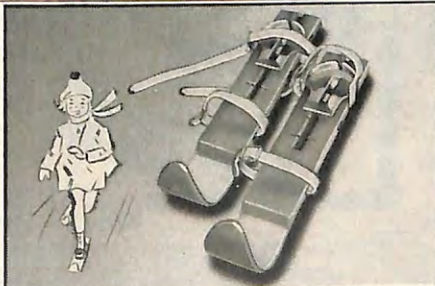

### Thrilling Snow Skates

The wonderful fun of skating and skiing combined in perfectly safe miniature skis! Steam-bent hardwood with sturdy fitted heel plates. Adjustable straps fit ages 4 to 11. Skates are 12½" long by 2¼" wide. Order No. T-4237, Snow Skates, \$1.79 pair, postpaid.



WRITE FOR FREE GIFT CATALOG!

**Miles Kimball**

421 Bond St., Oshkosh, Wisconsin



**THE BUSINESS GIFT THAT SHOWS REAL APPRECIATION: Famous Wisconsin Cheese**

**Pack No. 5** A truly representative assortment of fine cheese aged to perfection, contains Alpine brand swiss, brick, cheddar, baby gouda, dessert, blue cheese roll, smoky roll and wine cheese. Net Weight Over 4 lbs. Post Paid . . . . . \$6.55

**Free PLASTIC CHEESE PRESERVER BAG AND BEAUTIFUL FULL COLOR BROCHURE SENT ON REQUEST:**

1. Not sold in stores.
2. Enclose check or money order with all orders.
3. Prices include guaranteed safe delivery anywhere in U.S.A.
4. We will enclose a gift card bearing your name and make shipment in time for Christmas.

MEMBER: WIS. GIFT CHEESE SHIPPERS ASSOCIATION.

**THE SWISS CHEESE SHOP**  
BOX 4294 MONROE, WISCONSIN

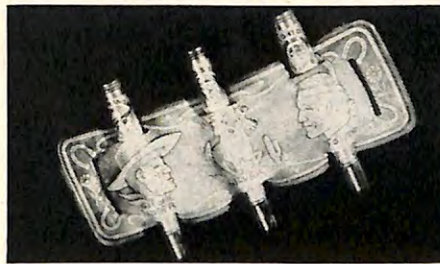

**THE LONE RANGER "writes" again.** 3 ball point pen "bullets" that write blue, red & green, slip over a belt in a leather cartridge holder, embossed with the Lone Ranger, Silver & Tonto. Only \$1 ea. Special Price of 6 Sets for \$5. Immediate delivery, No COD's. Send cash check or m.o. BOX 4035, DEPT. ELR TUCSON, ARIZONA

**WESTERN CLASSICS**



It's a "summer vacation" all winter when you

**TREAT the FAMILY to Genuine Battle Creek BISOLAR "SUNSHINE"**

Like a healthful, sun-tanned appearance all year 'round? Here's wonderful protection for you—and all the family—with scientifically balanced artificial sunlight! that contains both ultraviolet and infrared rays. "At the snap of a switch" the NEW BISOLAR Lamp delivers "made-to-order" light that tans faster than the sun. If you relax and fall asleep, automatic "Soltimer" turns lamp off at the preset minute—fully protects against overexposure! Pedestal, wall and ceiling models. Money-back guarantee. Write at once for free literature!

**Battle Creek EQUIPMENT COMPANY**  
BATTLE CREEK 13, MICHIGAN

# CINDY WALKER WALK HER DOLL

With Long, Silky, Washable SARAN Hair



- She Walks—Sits—Sleeps—Stands
  - Turns Head As She Walks
  - "Magic Action" Legs
  - Completely Washable
  - Unbreakable Construction
  - Guaranteed Walking Mechanism
  - LARGE 14" TALL
- CINDY DOES EVERYTHING**

Nationally Advertised At \$5.95  
**SENSATIONAL VALUE—ONLY \$2.98**

plus 50c shipping or C.O.D. plus postage

So Lifelike you'll think she's a real girl walking with her little mother. Cindy Walker is beautifully formed, even to the small details of finger nails, dimples and creases in her chubby arms and legs. She assumes and will hold (no flopping) all lifelike positions. Cindy can be washed, dressed and undressed in standard 14" doll costumes. Her hair can be washed and combed; her pigtails braided and set in any fashion desired. Nothing can go wrong with her working parts and she is molded of the new shockproof plastic that assures years and years of loving play. Cindy Walker is the answer to every girl's prayers. Commended by Parents' Magazine. Union-Made in U.S.A. by skilled American workers. Satisfaction Unconditionally Guaranteed! Price includes dress illustrated.

CINDY WALKER IS ALSO AVAILABLE IN THE LARGEST SIZE MADE—23" TALL WITH GENUINE MAMA VOICE. **Nationally advertised at \$15.95.** OUR PRICE \$3.95 plus 50c shipping or C.O.D. plus postage. REGULAR SIZE CINDY WALKER, 20" TALL WITH GENUINE MAMA VOICE. **Nationally advertised at \$9.95.** OUR PRICE—\$3.98 plus 50c shipping or C.O.D. plus postage.

**NOW YOU CAN DRESS CINDY, TOO—SAVE MORE THAN 50% ON HER CLOTHING**

STYLE	14" SIZE	20" SIZE	23" SIZE
HAT & COAT ENSEMBLE	79c	98c	\$1.10
BRIDAL ENSEMBLE	98c	\$1.49	\$1.79
PLAID VINYL RAINCAPE	29c	39c	49c
BALLERINA OUTFIT	49c	98c	\$1.10
HOSTESS COAT	29c	69c	79c
SNEER NIGHTGOWN	39c	59c	69c
<b>SPECIAL PRICE IF YOU ORDER ALL SIX OUTFITS \$2.98 \$3.98 \$4.98</b>			

**P. J. HILL CO.**

Dept. P-374

Newark 1, N. J.

## SHOE SHINE KIT

E-Z Shine Holders are made of strong aluminum. Detach from wall bracket. 3 changeable toe plates for men, women and children (for all size shoes). Chrome-like finish. C.O.D.'s pay postage. Look sharp at low cost. Guaranteed to give long, hard family usage.

A useful gift for all occasions



**\$2.95**

**WAYNE Mfg. Co.**

Dept. B-12, WAYNE, PA.

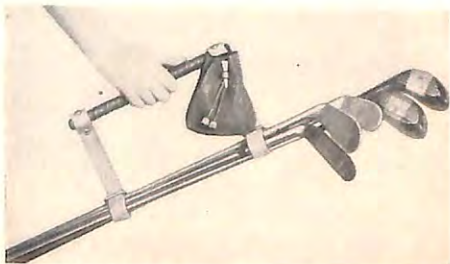

## NEW! wonderful gift for GOLFERS . . . \$4.75

Our new California Golf Carrier—just five ounces of steel and cowhide—cleverly designed to hold as many as eight clubs securely and in perfect balance. Handy pouch for balls and tees too. The modern way that makes golf easier, more fun . . . no more heavy bag or cart . . . the perfect gift for EVERY golfer! Money-back guarantee. Immediate delivery; gift boxed. By mail, only from us, postpaid, \$4.75. DEL-MEL CO., Dept. LK12, 237 Huguenot St., New Rochelle, N. Y.

# Elks FAMILY SHOPPER

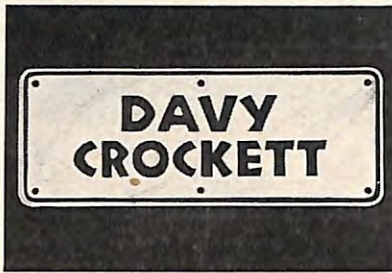

**ON THE TRAIL** your king of the wild frontier should be identified with this big, bold license tag. DAVY CROCKETT plate is the newest essential for bikes, trikes, scooters, wagons, etc. Letters are brown, embossed on yellow plate of 25 gauge steel, 8" x 3 1/2". \$1.00 ppd. B. Cantor, Dept. EM, 1711 Walnut St., Philadelphia 3, Pa.



**DO-IT-YOURSELF MOCCASIN KIT** gives children a real feeling of accomplishment when they wear these handsome, comfortable moccasins they've made. Of genuine glove-soft leather and Goodyear Airform insoles. Adjustable back, pre-headed toe. Natural color. Sizes: Small (5 to 7 yrs.); Medium (7 to 9); Large (9 to 12 yrs.) \$1.98 ppd. Wayne Mfg. Co., Dept. E, Wayne, Pa.



**THE URANIUM IN 'THEM THAR HILLS'** is found in rocks like these—a fascinating collection to launch any boy or girl on a brand new, exciting and educational hobby. Box of 15 different minerals, including 2 uranium specimens plus a leaflet describing the ores, only \$1.00 ppd. 6 boxes for \$5.00. Western Classics, Dept. EBR, Box 4035, Tucson, Ariz.



**FRESH ENGLISH HOLLY.** For your own Merry Christmas and as a refreshing surprise gift, order this big holiday box brimful of glossy green, ruby-red berried holly, gaily topped with a sprig of Mistletoe. Large sprays (about 15 per box) fresh cut and treated to keep that live-forest beauty. \$2.50 ppd. Shipped to arrive Christmas week. Northwest Corner Store, Dept. E, Longview, Washington.

a distinctive and personal gift

## TWO INDIVIDUALLY MONOGRAMMED MATCHED GRAIN EHRlich PIPES

complete in a satin lined, silver embossed jewel case . . . only **7.50** set postpaid

Since 1868, all over the world, Ehrlich pipes have been recognized as the ultimate in quality — the pipe that the connoisseur smokes. Here is your opportunity to give a complete set of 2 matched-grain Algerian briar pipes in popular shapes, monogrammed with 3 initials — at the amazingly low price of \$7.50.



**DAVID P. EHRlich CO.**

Dept. K, 207 Washington Street, Boston 8, Mass.



## SANTA goes WEST for BUCKETS OF ARDEN CHEESE

Four 4 1/2 oz. Glass Lined Mohony Wood Buckets filled with the best 4 varieties of Arden Famous Flavor Fresh, Taste Tempting cheeses. The finest in the country.

The four 8 oz. buckets (replicas of the old west) are highly decorated with shiny Brass bands and handle. Have many after uses. Packed in a beautiful foiled leatherette covered, re-usable Gift Box. Gold Embossed with Western Motif. An unusual, really exclusive LASTING GIFT

**BY MAIL ONLY \$7.25 PER BOX.** (Please add \$1 for mailing and handling.)  
**WRITE FOR LOW QUANTITY DISCOUNTS**

**BENNER GLASS CO.**

170 SAN FERNANDO RD • LOS ANGELES 31, CALIF.



**A GIFT SHE'LL TREASURE** is this imported set of unusual jewelry. Hundreds of tiny pieces of colored enamel are inlaid to form beautiful pattern of red roses in a jet black background. It's a centuries-old craft in Florence, Italy. Bracelet (6 links 1/2" wide) \$7.50, earrings (also pierced) \$3, the set \$9.50 postpaid (incl. tax). Add 35c Air Mail.

Money back guaranteed if not truly delighted.

**ALPINE IMPORTS** Dept. 9 505 5th Ave., NYC 17.

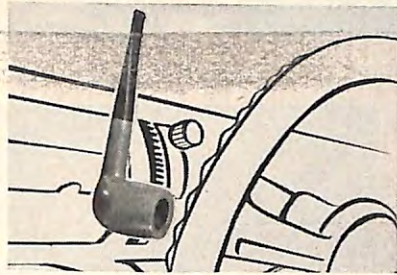

**MAGNETIZED PIPE.** You need no holder to rest this fine pipe of imported Algerian briar. Tiny magnet in the base of the bowl holds it firmly to any metal surface . . . on the dashboard while motoring, against your workbench or metal desk. \$3.65 ppd, includes 3-initial monogram. David P. Ehrlich Co., 207 Washington St., Dept. K, Boston 8, Mass.

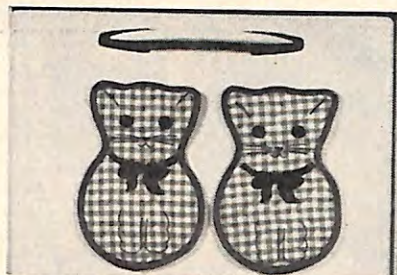

**THESE LITTLE KITTENS** will never get lost because they're magnetized. Pot Holders of heavily quilted washable percale, they conceal tiny magnets to make them stay put at the side of your stove, refrigerator or metal cabinet. Bright red, the pair is gift boxed, \$1.00 ppd. A perfect solution to those last minute gifts. Taylor Gifts, Dept. E, Wayne, Pa.

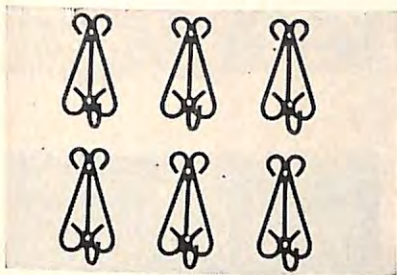

**MINIATURE HOOKS.** Whether you're hanging decorative copper molds, kitchen utensils, pot holders or fireplace accessories, you'll add a pleasing effect with these handy hooks. They're wrought of heavy metal and finished in satin-black. Set of 6, 2 1/2" high, with screws for easy mounting, \$2.95 ppd. Two sets, \$5.75 ppd. Laurie & Co., Dept. 12-E, 507 Fifth Ave., New York 17, N. Y.

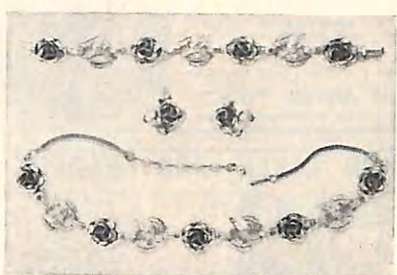

**ROSES THAT NEVER FADE.** Exquisitely sculptured in precious Sterling Silver with deftly hand wrought petals, this jewelry by Danecraft is as subtle a compliment as you can pay a woman. Necklace (16" to 18", adjustable) \$13.20; Bracelet (choice of 8" or 7 1/4") \$9.35; Earrings (screw-back or pierced) \$4.95. Set, \$26.00 ppd. inc. tax. Alpine Imports, Dept. E, 505 Fifth Ave., New York, N. Y.

# 49 1/2¢ STORM WINDOW

protects your family . . . all winter . . .

**No Nails  
No Hooks  
No Screws  
No Tools**



**JUST PRESS ON - That's all!**

Now . . . Storm Windows need not cost up to \$14.00. A world famous industrial firm has developed this light weight flexible product that seals out wintry blasts for as low as 49 1/2 cents a window! Imagine—for pennies you can insulate most ANY room in your home! This storm window is as transparent as glass yet can't peel, chip, shatter or rattle! Weighs less than 1/10 of the lightest glass windows developed—yet it has the tensile strength of over a TON per square inch! Crystal-clear, yet flexible like rubber! Not affected by snow, sleet, rain or dampness—because it's 100% waterproof. Won't crack at even 53 degrees BELOW FREEZING. Use and re-use YEAR AFTER YEAR for winter comfort and protection.



**INSTALL IN 5 MINUTES**

No nails, hooks, screws or tools. Just cut to fit window (any shape) then press on special Adheso border. That's all! No hard work no broken glass. Simple! Easy—a child can do it. Cleans easily with damp cloth, too! At winter's end, fold away like cloth for next year.

**Lift Border for Airing**

**Over 2,000,000 Sold**

No wonder so many homeowners, hospitals, churches use this tried and true product—over 2,000,000 sold last year! A 36" x 43 1/2" TRANS-KLEER kit—108 sq. feet, enough for 10 windows of 10.8 sq. feet—complete with Adheso Border is \$4.95, just 49 1/2¢ a window! 10 glass windows would cost \$79 to \$160—you save a terrific sum on purchase and on fuel savings! Play safe—order NOW on trial. We can produce only so much—no more. Act fast, mail coupon now. Enjoy new comfort, feel the difference—even test with thermometer. Then, if not convinced, your \$4.95 comes back! Only 2,500,000 can be made this year—and demand is going up! Avoid disappointment! RUSH COUPON TODAY!

**THORESEN'S, Dept. 103-N-47**  
352 Fourth Avenue, New York 10, N. Y.

**RUSH . . . . .** Kits Trans-Kleer measuring 108 sq. ft. (10 windows averaging 10.8 sq. ft. each), with Adheso Border on 7 day trial—money back guarantee.

- Payment Enclosed. Send Postpaid.
  - Send C.O.D. plus postage.
- CHECK AMOUNT DESIRED**
- 1 KIT (108 sq. ft.) for 10 windows — 4.95
  - 2 KITS (216 sq. ft.) for 20 windows — 8.95

Name.....  
Address.....  
City..... State.....

Canadians: Same price & guarantee! Order from our Canadian Subsidiary: THORESEN LTD., 45 St. James St., W., Dept. US-47, Montreal 1, Que.

**Scotch Rye Bourbon Flavored TOOTHPASTE**  
\$1.50 EA. Postpaid

Everyone will brush their teeth a dozen times a day and your boss will give you a raise when you "gift" them with this novel new toothpaste idea. It's six proof . . . It's genuine scotch, rye and bourbon whiskey flavored. Give all three flavors and you'll be talked about forever as the year's most original gift giver.

**FREE! New Gift Catalog**  
**TAYLOR GIFTS, Wayne B 12, Penna.**

**RELAX IN**

**PATAKWA MOCCASINS—Ideal Gift**  
from the Indian Reservation Country of soft, washable sueded cowhide, with flexible padded soles. **BLISS TO WEAR** indoors or out with cuffs rolled up or down.

**HANDCRAFTED** in Natural, Turquoise, Brown, Red, Em. Green, Golden Corn, Russet, Indian White.

**FOR MEN AND WOMEN** in sizes 4 to 8 . . . . . \$4.95  
in sizes 9 thru 12 . . . . . \$5.95

**FOR CHILDREN** too, in natural or brown only.  
Sizes 5, 7, 9 . . . \$2.95    Sizes 11, 13, 2 . . . \$3.95

Send cash, check or m. o. For COD's send \$2 deposit. Immed. delivery. Satisf. guar. Gift orders carefully handled. Box 4035, Dept. EP-1 Tucson, Arizona

**OLD PUEBLO TRADERS**

**SAVES 20 MIN. POTATO BAKING TIME**  
Potakor is NOT a rod to be left in potato while baking but a coring tool which cuts a small clean hole clear thru the potato before baking. This correctly allows free escape of excess moisture thus producing a delicious mealy (never soggy) baked potato in fifteen to twenty minutes LESS BAKING TIME. Simple directions enclosed. Makes perfect Xmas gift for friends and neighbors. Send \$1.00 airmail for earliest delivery to Potakor Co., Box 143, Toluca Lake Station No. Hollywood, Calif. Tax and postage paid.

**UNIQUE CHRISTMAS GIFT**  
**HOME CIGARETTE PACK DISPENSER**

solves the problem of where to keep your cigarettes. Fastens to wood, metal, or tile. Available in 2 sizes to hold carton of regular or king size. Lasting plastic—in mahogany or ivory finish. \$1 ea. 6 for \$5. Ppd.

**ROBCO PRODUCTS CO.**  
4160 Drew Houston 4, Tex.



## Every Golfer Wishes He Owned a Scorekeeper!

Chromeplated golf scorer, worn on the wrist, registers the stroke and hole you are playing. A click of the button keeps your score; eliminates the need to tabulate with pad and pencil. With genuine leather watch strap. Satisfaction **\$3.98** guaranteed! Postpaid

LOWY'S CREATIONS, 260 E. 116th St., Rockaway Park, N.Y.



## WOWEE! 50 TOYS—\$1.00

Imagine! 50 full dimension scale model cars and airplanes; U.S. fighters, supersonic jets, multi-engined transports, bombers, service cars, tow-trucks, high-way vans, busses, cars. PLUS 10 more toys free including tiny tools for your Jr. Mechanic. 60 toys in all, fully assembled, made of colorful break-resistant plastic. Loads of holiday fun for youngsters 4-80. End to end they measure 10 feet! ORDER NOW! Send only \$1, plus 10c postage (tot. \$1.10) for each set, gift boxed, or \$3.75 for 4 sets post-paid. Rush order to: LARSANS, 4238 Harwood Ave., Dept. TC-12, Cleveland 21, Ohio.

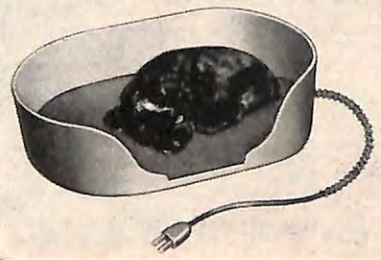

**A WARM BED** for your dog with Lectro-Kennel. Plug into any 110-volt outlet. Pre-set unit maintains comfortable, healthful temperature. Fully insulated and sealed against moisture, shock or short. Protected lead-in cord. Sturdily built of aluminum with replaceable felt pad. Uses same electricity as 40-watt bulb. Size, 20" x 14". For indoor use only. (Write for information on other models). Prepaid, \$15.95. No C.O.D.'s. Satisfaction-or-money-back-guarantee. Lectro-Kennel, P.O. Box 2042, South Bend, Indiana.

**LIFE SIZE PRINTS OR GREETING CARDS**

# MARILYN MONROE

**ALSO GORGEOUS LILI ST. CYR**  
Glamorous Anita Ekberg, Pat Hall, Joanne Arnold, Madeline Castle

**THINK OF IT! THEY'RE 5 FEET TALL IN FULL COLOR**

Big as life and twice as natural! Eye-stopping ACTUAL FULL COLOR photos—5 FT. TALL, 21 1/2" wide. Sensational gift or party gag. Use 'em for den, playroom, bar! On doors, screens, as wallpaper! Terrific as greeting cards (Christmas, Birthday, Get Well, Thank You, New Years, Valentine, many others—detachable greetings won't spoil prints—specify, we'll sign and mail). \$2 each. Two for **\$3.75**. All six \$11. Postpaid, in plain wrap. Send cash, check, M.O. Money-back guarantee.

**LIFE-SIZE, Dept. EK12-5**  
216 Tremont St., Boston 16, Mass.

## FORCES You to Save \$100.00 a Year Automatically!

Get Perpetual Date & Amount Bank, 25c a day keeps Date right up-to-date. Also registers amount saved. Forces you to save a quarter every day, or date won't change. Use year after year. Start saving right away. Order several. Reg. \$3.50—Now only \$1.99 postpaid. Mail cash, check or money order to L E E C R A F T, Dept. EL, 300 Albany Ave., Brooklyn 13, N. Y.



## Pencil Clown

has a bright red nose which is a pencil sharpener, a saucy stuck-out tongue which is an eraser, and three holes in his head which are slots for pencils. Made of wood, his suction cup base adheres firmly to desk or table. Complete with 3 colorful pencils.

**\$1.00** Postpaid

Send For New Free Catalog

**THE ADDED TOUCH**  
(Dept. E12) Wynnewood, Penna.



## END TABLE - BED READER



### COMBINATION ADJUSTABLE TABLE

Aluminum and Clear Plastic—Light—Sturdy—Beautiful—4 Positions—Quick change—Useful Gift for the Sick or Well—Old or Young. No more tired arms from reading in bed—place book or magazine back of and resting on plastic and read thru clear plastic. Adjust to "Kiddie Desk"—ideal for tracing. Perfect for sitting up and writing in bed. Only \$12.95 in USA—Send Check or Money Order. We pay postage except on COD's. For a.s.d. send \$3.00 Deposit. Florida residents add 3% sales tax.

**SAUNDERS ENTERPRISES**  
DEPT. EL, BOX 828, LAKE WORTH, FLORIDA



## "TY-HOLD"-TIE RACK

### The Most Practical Tie Rack Ever Made

With a flip of the finger, you unlock ties for easy selection. Another flip, ties are snapped securely in place. Beautifully finished wood, inlaid in 3 different colors to keep similar-colored ties together. Holds 2 doz. Ties, Belts, etc. Comes in handsome gift box. \$2.75 ppd. (add 25c w. of Miss.)

Pre-Christmas Delivery Guaranteed on orders received by Dec. 15th

A. J. HORT CO., 3 W. 29 St., New York 1, N. Y.



### LIVING BIBLE RECORDS

KING JAMES version of St. Matthew, read, interpreted by Albert L. Hoy, Ph.D., ordained minister, college professor. Crystal-clear utterance, pleasing tone quality against background of soft sacred organ music. Brings Christian message to entire family. Supplements Sunday School work. Also ideal gift for blind, shut-ins, handicapped, 10", 33 1/3 RPM. 3 1/2 hrs. Vinyl. Summary of New Testament on L.P. Vinyl. Record Only \$1.50 Ppd.

6-50

Ppd. Send Check or M.O.

RECORD BROADCAST CORP.  
1440 Seabright Ave., Long Beach 13, Calif.

## Elks FAMILY SHOPPER

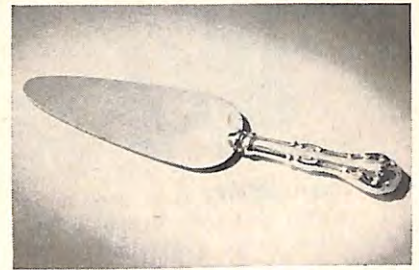

**A STERLING IDEA** for a gift is this Cake and Pie Server with its 4" Sterling Silver handle. The stainless steel blade is serrated to make it cut smoothly through any cake. While you're at it, buy one for yourself too. At this price, you'll find it hard to duplicate. \$4.95 ppd. inc. tax. Kyseth Jewelers, Dept. E-12, Clarion, Iowa.



### SENTIMENTAL JOURNEY PICTURE FRAMES.

Someone you know who loves "the good old days" is sure to appreciate the humor in this pair of wood frames, reproducing in minute detail an automobile and carriage from the gaslight era. 3 1/2" x 4" with picture opening 2" x 1 1/2". Easel backed. Pair, \$3.00 ppd. Old Mexico Shop, Dept. E, Santa Fe, N. M.



**SLEEP WELL**, cuddled by this dream of a Comforter. Filled with non-allergic, washable Dacron, it's as fluffy and luxurious a puff as ever graced a bed. Magnificently quilted, 72" x 90" in nylon crepe or chromspun tafeta—pink, blue, white, maize, green, wine; 72" x 84" in satin—pink, blue, green, gold. (Give alternate color). \$24.50 ppd. Stewart Slumber Shop, 528E Madison Ave., New York, N. Y.



# ELKS FAMILY SHOPPER



**INSTANT COFFEE DISPENSER** insures consistently good coffee because it measures out the correct amount each time. No guesswork, no spilling, no waste. What's more, it replaces the jar's lid so contents stay freshly air-tight to the last grain. \$1.00 ppd. Keenan Sales, 945-E Wilshire Blvd., Los Angeles 17, Calif.



**THE LIVING BIBLE** is an inspiring recording of the Holy Scriptures on 10"-33 $\frac{1}{3}$  rpm long playing records. Read by an ordained minister against a background of sacred music, this is a gift to be cherished. The New Testament (King James Version) consists of 8 volumes from \$4 to \$6 per vol. plus postage. Record Broadcast Corp., 1440 Seabright Ave., Long Beach 13, Calif.



**A GOLFER'S CHRISTMAS STOCKING** is not likely to hold a more welcome gift than this Personalized "Life-Time" Golf Tee. The Tee-Matic is an engineered tee incorporating a flexible spring that bends to a 90° angle in any direction, automatically returns to upright. Brightly lacquered brass with initialed brass tag. Print initials. \$1.00 ppd. Golf Shop, 31 W. 47 St., Dept. E. New York 36, N. Y.

## WROUGHT IRON SWITCH PLATES

**ATTRACTIVE PRACTICAL and DURABLE** electric switch ornaments.

Designed to add warmth and beauty to the walls of any styled home from Provincial to Modern. These handsome black wrought iron scrolled-framed plates fit over any wall switch or outlet. Give added protection to walls from finger marks. Ideal for any room. Living Room, Kitchen, Bed Room, Den, Foyer, etc.

• 1 Single Switch \$1.35 ea. • 2 Triple Switch \$1.95 ea. • 3 Double Outlet \$1.35 ea. • 4 Double Switch \$1.65 ea. • 5 Combination Switch and Outlet \$1.95 ea.

Other types available including Despard Plates. No C.O.D.'s please. We pay postage. Money refunded if not delighted. Order NOW!

• Write for FREE Gift Catalog •  
Dept. E-11, 507 5th Ave. New York 17, N. Y.

**Laurie & Co.**

## MODERN CONVENIENCE FOR HOME, OFFICE OR CLUB

**MAKE PERFECT GIFTS FOR CHRISTMAS, WEDDINGS, BIRTHDAYS, SPECIAL OCCASIONS. IDEAL FOR GUEST BEDROOM, CLOSETS, VESTIBULE OR CLUBROOM. EASY TO INSTALL—HANDSOME TO LOOK AT.**

**New space saving Master Wal-Hook, chrome plated 3/2" and 3/4" tubular steel, mounts on wall—screws supplied. Hooks have black plastic tips. Length, 15", extends only 5" from wall. Order No. 55-4, only \$3.95.**

**Master Wal-Robe, holds hats, packages—rod below holds coats and suits on hangers. Chrome plated 3/4" tubular steel. Sturdy one-piece frame—no welds to break. Shelf, 24" long, 11" wide. Plastic tips protect wall. Screws included. Order No. 55-3, only \$5.95.**

**Luggage Master, handsome chrome plated 3/4" tubular steel, 24" long, 18" high, 16" wide. Has four smart black and white Saran Plastic straps. Black plastic tips protect floor. Folds instantly for storage. Rugged, long-lasting—no rivets or welds to loosen. Back rest keeps luggage from marring walls. Order No. 101-WB, only \$9.95.**

SEND CASH, CHECK OR MONEY ORDER. DEPT. E-12. ALL ITEMS SENT POSTPAID. SORRY NO C.O.D.'S.

Order Today—Money Back Guarantee

**KEDRON Shop** OLIVET, MICHIGAN

## Please HIM... Give HIM A "SMOKER'S CADDY"

Once you've used a "Smoker's Caddy" all other so-called ash trays will become ornaments.

The patented Life-time Ash Tray—clean, unbreakable, attractive—made of Steel, Nickel Plated, High Finish.

The prongs or fingers of the "SMOKER'S CADDY" hold the cigarette securely—eliminating any possibility of the cigarette sweating underneath, a distasteful occurrence common to the ordinary ash tray. . . . The "SMOKER'S CADDY" allows you to continue a pleasant smoke while reading, writing, working or relaxing. To extinguish the cigarette, simply place it upright in the snuffer . . . and the fire is immediately killed with no disagreeable smoldering odor.

**Sold with Money Back Guarantee. Send Check or Money Order for your "Smoker's Caddy" today. ONLY \$1.95 Postpaid**

**GORHAM INSTRUMENT COMPANY**  
287 Atlantic Avenue, Boston 10, Mass.

## 100 Toy Soldiers \$1.00

Still available at original low price! 100 molded plastic Toy Soldiers for only \$1. This big colorful assortment includes 4 Riflemen, 8 Machine-gunners, 8 Sharpshooters, 4 Infantrymen, 8 Officers, 8 Cannon, 4 Bazookamen, 4 Marksmen, 4 Tanks, 4 Trucks, 4 Jeeps, 4 Battleships, 4 Cruisers, 4 Sailors, 8 WAVEs, 8 WACs, 4 Bombers and 8 Jet Planes. Each toy is completely assembled, designed to scale, and measures up to 4 1/2". Order several sets NOW for early Christmas delivery; your kiddies will love them. Send \$1.00 plus 25c for postage and handling for each set of 100 toys. No C.O.D.'s please.

H & J TOY CO., DEPT. 4  
1840 Griffith Park Blvd. Los Angeles 26

## GENERATOR FLASHLIGHT NEVER FAILS

Needs No Batteries \$4.95 Postpaid

Imported from Western Germany it generates its own power, never needing batteries replaced, and is always ready for instant use. It fits the palm of your hand and is operated by a gentle squeeze of the generator lever. Shatter proof metal housing. No home, auto, or boat should be without one.

FREE! New Gift Catalog Dept. B 12 Wayne, Penna.

**TAYLOR GIFTS**

## "MY GREY HAIR IS A NATURAL LOOKING COLOR AGAIN" says JAN GARBER,

Idol of the Airlines

"TOP SECRET gives my grey hair a natural looking color!" says famous dance band leader Jan Garber. "I noticed results after just a few applications. And TOP SECRET is easy to use—doesn't stain hands or scalp. TOP SECRET is the only hair dressing I use."

**A FAVORITE OF THE STARS**

TOP SECRET has been a favorite with famous personalities for years. Exclusive formula imparts a natural looking color to grey or faded hair. Does not streak or injure hair; does not wash out. Send \$5.00 (Fed. Tax incl.) for 6 oz. bottle. Postpaid. No C.O.D.'s, please. Money back if you're not delighted with results. Albin of California, Room 412, 1401-91 W. 8th St., Los Angeles 17, Calif.

## DUNCIE, THE COLORFUL CLOWN

Children say I'm loads of fun; nice to cuddle and hold. Oldsters say I'm easy to make of fabrics bright and bold. I always wear a happy smile! You'll never see me cry. Takes 15 minutes to assemble me—and I'm almost two feet high. I'm all set ready to ship. I'll make a wonderful gift. Send only \$1.25 per doll today and give all the kids a lift. Only \$1.25 postpaid. Order several now for Christmas. Satisfaction guaranteed. Marie O'Connell, 4080 Lincoln Blvd., Venice 4, Calif.



### WINDSHIELD DE-ICER WIPES AWAY COLD WEATHER BLUES!

The most talented car tool on the market! It eliminates the need for make-shift remedies by swiftly removing snow and ice without scratching windshield—perfect for frost-free winter weather vision. In heavy plexiglas with an accurate compass in its middle, a practical key chain attached to its handle. Measures 4" long with one engraved initial. A wonderful cold weather gift!

ONLY \$2.00 ppd.

Write for FREE catalog.  
**BODINE'S**  
501 E. Preston St. Baltimore 2, Md.



### SAFETY GLASSES CASE!

Saddle leather case. Stays in your pocket. Spring clip holds glass firmly in pocket or on auto sun-visor. Finest workmanship, best quality tan colored saddle leather. Eliminates wear and soil to clothes. Protects glasses from normal breakage and loss. Wonderful gift item! Model 236, Glasses Case—\$1.50. Model 237, Glasses, Pen, Pencil Case—\$2.00. In Calif. add 3%. Money back guarantee. NELSON'S, Dept. E-125, Sierra Madre, Calif. No C.O.D.'s. Send for Free Gift Catalog.

### The New Model 70 UTILITY TESTER FOR REPAIRING ALL ELECTRICAL APPLIANCES MOTORS·AUTOMOBILES·TV TUBES

As an electrical trouble shooter the Model 70:



- Measures A.C. and D.C. Voltages, and D.C. Current, Resistances, Leakage, etc.
- Will measure current consumption while the appliance under test is in operation.
- Incorporates a sensitive direct-reading resistance range which will measure all resistances commonly used in electrical appliances, motors, etc.
- Leakage detecting circuit will indicate continually from zero ohms to 5 megohms (5,000,000 ohms).
- Will test Testers, Irons, Broilers, Heating Pads, Clocks, Fans, Vacuum Cleaners, Refrigerators, Lamps, Fluorescents, Fans, Switches, Thermostats, etc.

Will test all TV tubes for open filaments, inter-element shorts, burned out tubes, etc.

As an Automotive Tester the Model 70 will test:

- Both 6 Volt and 12 Volt Storage Batteries
- Generators
- Starters
- Distributors
- Ignition Coils
- Regulators
- Relays
- Circuit Breakers
- Cigarette Lighters
- Stop Lights
- Condensers
- Directional Signal Systems
- All Lamps and Bulbs
- Fuses
- Heating Systems
- Horns
- Also will locate poor grounds, breaks in wiring, poor connections, etc.

Handsome round-cornered molded bakelite case, 3 1/2" x 5 7/8" x 2 1/2". Complete with all leads. Also included is a 48 page book giving detailed instructions for testing all electrical appliances, automotive equipment, TV tubes, etc. Only \$15.85

**SHIPPED ON APPROVAL  
NO MONEY WITH ORDER—NO C.O.D.**

Try it for 10 days before you buy. If completely satisfied then send \$3.85 and pay balance for 3 months—No Interest or Finance Charges Added! If not completely satisfied, return to us, no explanation necessary.

MOSS ELECTRONIC DIST. CO., INC.  
Dept. D-175, 3849 Tenth Ave., New York 34, N. Y.

Please rush 1 Model 70. I agree to pay \$3.85 within 10 days after receipt and \$4.00 per month thereafter.

Name \_\_\_\_\_  
Address \_\_\_\_\_  
City \_\_\_\_\_ Zone \_\_\_\_\_ State \_\_\_\_\_

**SAVE ON XMAS GIFTS** BUY DIRECT FROM IMPORTER  
COMPLETE CAMP KIT  
Special 12 Pc. SPORTSMAN'S KNIFE  
OVER 10,000 SATISFIED CUSTOMERS ORDER TODAY  
GENUINE 4 3/8" BONE HANDLE  
Complete with Genuine Leather Holster!

IDEAL GIFT FOR FATHER, SON OR FRIEND...  
Eliminates 12 Individual Items from Pack or Tool Kit  
Here is the Perfect, Combination Knife-Tool for every Outdoor Sportsman, Hunter, Camper, Fisherman, Boy Scout, Ranger, Rancher, etc. Think of it! 11. Fine quality Steel Tools, precision made to fold easily into the heavy bone covered body. In one neat, compact unit you have (1) a regular knife, (2) a fork, (3) a spoon, (4) a draw-knife, (5) a bone-saw and fish-scaler, (6) scissors, (7) a can and bottle opener, (8) a cork-screw, (9) awl punch, (10) a screwdriver and (11) a metal file. All this PLUS a genuine leather, belt holster

3400 RPM—1/2 HP POWER SAW  
COMPARES TO SAWS SELLING UP TO \$49.50 WITH A 5 1/2" BLADE  
RIPS - CROSSCUTS CUTS FINISHED 2x4 LIKE KNIFE THROUGH BUTTER  
A rugged, professional type, adjustable saw. Will cut any angle from 0 to 45°. Has an adjustable (0 to 6") rip fence. Safety-trigger switch on handle. Full 1/2 HP Universal AC-DC, 110-120 Volt, 60 cycle motor. Weighs only 6 1/2 lbs. Thousands already sold. Your satisfaction guaranteed.  
EXTRA SAW BLADES—Available in Rip, Crosscut or Combination. Please Specify . . . price per each \$2.75 EA.

**SATISFACTION GUARANTEED OR MONEY BACK**  
ORDER TODAY for Xmas Delivery—Pay by Money Order or Check. 1/2 deposit with C.O.D.'s. All prices F.O.B. Los Angeles.  
**Palley's** 2263 E. VERNON AVE., DEPT. E-12 LOS ANGELES 58, CALIF.

A GIFT HE'LL ALWAYS CHERISH



Other gifts he will get but this, a handsome 10kt Gold, richly enameled Elks insignia is one he will treasure for years ahead. Like other official Elk emblem pins it is approved by the Grand Lodge. A truly fine example of jeweler's art and craftsmanship and a gift that will demonstrate your thoughtfulness. Illustration shows pin indicating 15 years membership in the Elks. Please order by number. No. 5 (above) 15 year pin, 10 kt gold, red, white and blue design. Post and attaching button gold plated. Price \$7.35. No. 4 slightly different design as No. 5 but with 10 year membership designation also \$7.35. Prices include Federal tax. Delivery within 2 weeks. For N. Y. City purchase add 3% sales tax. Order your gift pin today from THE ELKS MAGAZINE, 50 E. 42nd St., N. Y. 17, N. Y.



FOR YOUR GIFT LIST...  
**HAND MADE BY FAMOUS ZUNI INDIANS**  
CUFF LINKS of beautifully polished agates or other semi-precious stones. No two alike. Sterling silver mounts. Elk head in 10K white gold with tiny jeweled eyes. Exquisite. Hand wrought in Mexico by Zuni Indian gem and silver craftsmen. Also available with one initial or plain. Choice of large or medium stone. Beautiful Christmas package. With emblem or initial, \$15.95. Plain \$13.95 pr. Postage and tax paid. You save about \$6 pair. Money Back Guarantee. Order now.  
S&M NOVELTY CO., Dept. E, Box 1128, W. Arcadia, Calif.

## Elks FAMILY

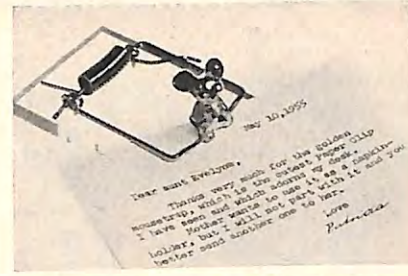

IT'S A TRAP to give you the snappiest looking Paper Clip ever. A tiny gold-plated mouse, black-eyed and red-eared, sits on a gold-plated spring anchored to a block of transparent lucite, 3 1/4" x 2". Besides clipping your papers, it acts as a paperweight. \$1.10 ppd. Bodines, Dept. E, 501 E. Preston St., Baltimore 2, Md.

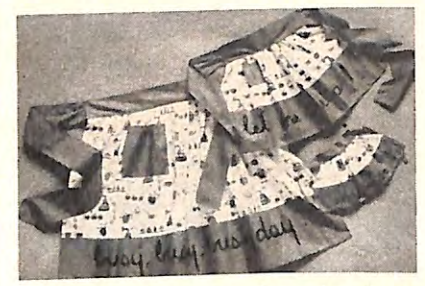

A BUSY TRIO are mother, daughter, and doll or baby sister, all togged out in matching Busy Day Aprons. And don't be surprised if the wee one steals the show. Gay print on white ground, red trim and black lettering on fine cotton broadcloth. Mother's, \$2.95; Daughter's, \$1.95; Doll's, \$1.00; Set, \$5.50 ppd. Edwin House, 145 W. 4th St., Dept. E, New York 12, N. Y.



BEAUTIFUL GIFT PACKAGE BOWS like these are easy to make even if you're "all thumbs", thanks to Peg-A-Bow. This new bow machine makes hundreds of distinctive, professional looking bows from ordinary ribbon in minutes. It also enables you to make novel Christmas tree ornaments, party favors and decorations. \$2.00 ppd. Magay Corp., Box 74-E, Bayside 60, N. Y.

Please mention The Elks Magazine when writing to our Elks Family Shopper Advertisers.

# SHOPPER



**CHOO CHOO BOX** with handpainted colorful train design, has four colored pencils, a top that slides open and child's name painted on cover. 9 1/2" long. It's a good gift for all the young students, boy and girl, on your list. Print child's name, \$1.00 ppd. Atlas Gift Co., Dept. E, New Hyde Park, New York.



**OVERALL PROTECTION** from wind and rain is yours in this Two-Piece Rain-suit of Dupont Nylon. Slip-over Parka has attached hood, 9" zipper opening, full cut raglan sleeves, under-arm ventilation, elastic at wrists. Overalls have adjustable suspenders, snap closure. Small, medium, large, extra large. Two-piece suit, \$10.98 ppd. Strago Mfg. Co., 874 Bway, Dept. ER, New York, N. Y.



**A GAY DOG** on Christmas morning should sport this Holiday Dog Collar. On a white felt background, the word "Noel" is embroidered in green sequins, flanked by green felt leaves and red berries. It's backed with red leatherette for comfort. Adjustable. State breed of dog. Personalized (up to 6 letters) if you like. \$1.95 ppd. The Sea Horse, Dept. E, 727 Sheridan Rd., Evanston, Ill.

You've ample time to order for Christmas from these pages and avoid crowds. But act promptly.

**The most "taste-full" gift... FORST CATSKILL MOUNTAIN Smoked TURKEY**

So wonderfully tasty . . . and in such wonderful taste . . . when you give a magnificent Forst Catskill Mountain Smoked Turkey! Each tender, juicy morsel, a taste-thrill! Each golden-brown bird is succulent, smokesweet to the bone. Only we Forsts know the secret of such indescribable feasting. We cure our plump birds in rare, zesty spices, aromatic herbs, slowly smoke them over fragrant applewood according to our generations-old family recipe. Whole smoked turkeys range from 8 to 20 lbs. (net smoked weight). All ready to slice and serve. Price of \$1.75 per lb. includes delivery charges, festive gift-wrapping. Order today, solve all your Christmas gift problems the Forst way! State date required.

**THE FORSTS**, Route 398, Kingston, N.Y.  
All Forst Products are Government Inspected

**STOLEN FROM**  
*The Ritz*  
**THE PLAZA**  
*The Astor*

**STOLEN GOODS**

Intriguingly honest—fluffy white Cannon guest towels boldly stating in Red, Black and Green that they are stolen from famous hotels. This set of three 11" x 17" towels is beautifully boxed with golden metal chain and twin locks encircling the "Goods." Amusing and practical—nice for hostess gifts and for those who "have everything."

Orders received up to Dec. 20 are delivered in time for Christmas

Set **\$3.98** ppd.  
2 Sets **\$7.75** ppd.

**FREE Gift Catalog**  
**LEISURE INDUSTRIES**  
Dept. 5, 96-09 Metropolitan Ave., Forest Hills 75, N.Y.

**This Christmas Give Yourself—Your Friends This Blessed Gift of SLEEP**

Everybody loves this new **BLANKET SUPPORT** because it frees their feet from blanket weight. NOW they sleep quietly relaxed and awake refreshed. The difference is truly amazing! Ingenious folding arms make a cozy, restful foot packet indispensable to uncomfortable sleepers. Relaxes tension that cause insomnia and irritations. Improved circulation eases rheumatism and foot cramps. Increases electric blanket comfort. Enjoyed by arthritics and the aged. Fits any bed. Arms fold down flat when bed is made. Praised by thousands of restless sleepers, doctors and hospitals. Tested and approved by "Foot Health Committee, N.Y.C." A Christmas gift guaranteed to please, or your money back. Send only \$3.98 plus 25c postage.

S1 Higher in Canada, Duty Free

**BETTER SLEEP INC.**  
Dept. 467, New Providence, New Jersey

# LIGHT UP...

... to refrains of **AULD LANG SYNE** with your own **MUSICAL...**

**CIGARETTE BOX**  
**\$9.95**  
*official cloisonnee seal on cover*  
**MAHOGANY OR WALNUT**

**PIPE RACK HUMIDOR**  
**\$12.95**

Raise lid—genuine Swiss movement plays your favorite song . . . at home . . . office . . . den. Free booklet sent upon request showing other Fraternal, College and Military Selections.

Send for yours TODAY!

## RAMAR Specialties

420 YALE AVENUE • ROCKVILLE CENTRE, N. Y.  
SENT POSTPAID, NO C.O.D.  
SATISFACTION GUARANTEED

**AUTO EMBLEM** for license plate identifies the owner as Elk, MD, DDS, RN, Pharmacist, Member of Fire Dept., Aux. Police, Civil Defense, Clergy, Mason, Shrine, Kiwanis, Odd Fellows, K. of C., Rotary, K. of Pythias. Of sturdy cast aluminum—painted in correct insignia colors. **\$1.49**; 2 for **\$2.50**. Money-back guarantee. Your own design made-to-order (min. 50).  
**Sta-Dri Co., 47Y 6th Ave., Whitestone, L.I., N.Y.**

**MAKE YOUR HOME A SHOWPLACE THIS CHRISTMAS WITH...**

**SNOW-KIT**

Anyone can spray designs on windows, doors, etc. . . or spray your tree!

**YOUR CHOICE**

1. 1-gal. cn. white—1-gal. cn. red plus 7 stencils	<b>\$198</b>	Ea. ppd. Sorry No C.O.D.'s
2. 1-gal. cn. white—1-gal. cn. blue plus 7 stencils		

Easy to Apply . . . Easy to Remove  
**ORDER SEVERAL KITS TODAY**  
"SNOW" Box 1422  
Detroit 31, Mich.

# Cut DRIVING FATIGUE— Travel Relaxed



## NOW! DANDY BACK REST

offers you comfortable, tension-free driving. Here's how: Relieves strain and increases safety by providing the best driving posture for you. Improves visibility and steering control, too. Rattan construction conforms to the shape of your back, assuring lasting comfort. DANDY takes the perspiration out of summer travel, circulates clean, cool air between you and hot, sticky auto seats. DANDY Back Rest is a must for really easy driving. Attractive Blonde Finish. **\$6<sup>75</sup> ppd.**

THE HILL COMPANY, P. O. Box 646, Syracuse 1, N. Y.

**NOW WRITE IN**

SILVER & GOLD

Only **\$1.00**

Imagine! For the first time you can write in real silver or gold! Personalize Christmas cards! Initial luggage! Protect cherished belongings. Write on checks, stationery, books, cards, records, etc. Hundreds of uses for this amazing new writing kit. Complete with professional stylus plus generous supply of silver or gold ink for just \$1.00 ppd. Order both gold and silver for just \$1.89 ppd.

**ORDER FROM HOME SHOPPER** 667 N. FAIRFAX AVE. LOS ANGELES, CALIF. DEPT. E-7

## HI-FI THEATER PIPE ORGAN



By **Truman Welch**

Choice of 3 Albums, 10", 33-1/3 RPM Vinyl Records **\$3.15 Each Ppd.**

Ideal Music Lover's Gift. Send check (M.O.). C.O.D.'S Postage Extra.

- |  |   |
|--|---|
| <p><b>NO. 608</b></p> <p>Romance<br/>Frasquita Serenade<br/>Villa<br/>La Rosita<br/>Pizzicato Polka<br/>La Camparista<br/>Someday<br/>Serenade</p> | <p><b>NO. 612</b></p> <p>I Love You<br/>Kiss Me Again<br/>Ramona<br/>Blue Tango<br/>I'll Always Be In Love With You<br/>Smoke Gets In Your Eyes<br/>Mexicali Rose<br/>The Swallow (La Golondrina)</p> |
|--|---|
- NO. 614**
- I'll See You In My Dreams  
One Kiss  
Bill  
In The Mission Of St. Augustine  
Diane  
Many Times  
The Syncopated Clock  
My One And Only Highland Fling

**RECORD BROADCAST CORP.**  
1440 Seabright Ave., Long Beach 13, Calif.

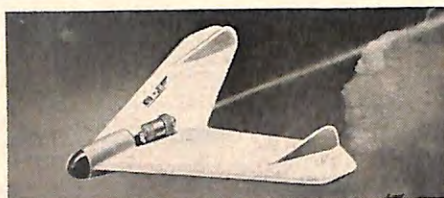

## It's here—Nova-JET®

first real miniature plane! (ready to operate—nothing to build)

Wonderful outdoor excitement, looks and acts like a real jet, producing a realistic vapor trail as it soars. This sleek delta wing model takes off into the wind like its big brother jets; can be made to stunt and do all types of maneuvers. Can be hand launched or catapulted. Flight can be controlled so that plane can come back to you. Safe—ready to operate—nothing to build. Made of feather-light, sturdy plastifoam, complete with engine, plenty of jet fuel pellets, instructions, catapult, wing spread 10 1/2". **\$4.95 ppd.**

For Guaranteed Christmas Delivery, 35c add'l (Special Delivery)

**HERE'S HOW** Dept. EK-12, 27 E. 22nd St., N. Y. 10

## IVES MEAT-LIFTERS



Send check or money-order—sorry, no C.O.D.'s. Money-back guarantee. **\$2<sup>75</sup> per pair** plus 25c postage in U. S. A.

... the perfect practical gift for the Gourmet!

For any occasion, give a pair of Ives Meat-Lifters. Your thoughtfulness for safety in handling large roasts, hams, steaks, and fowl the easy, convenient way, will be doubly appreciated. No spills—no painful burns—no loss of juices. Approximately 11" long; overall tine spread 6 1/2"; positive grip finger-fitting handles. Mailed in self-storage box.

**IVES NEW PRODUCTS, Inc.**  
211 Medical Arts Building • Richmond, Indiana

## Elks FAMILY

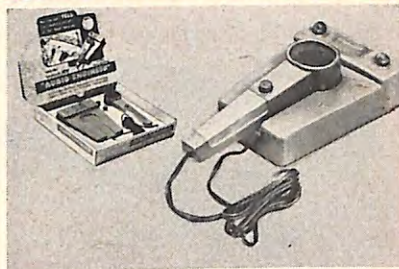

**ELECTRIC TRAIN OWNERS** can now control their trains by voice like a dispatcher. "Audio Engineer" hooks up to Lionel or American Flyer electric trains and electronically transmits voice messages spoken into the microphone, making trains go, stop and back up. Red and green lights flash commands. \$4.95 ppd. Magic Mold, Dept. EK, 467 Livonia Ave., Brooklyn 7, N. Y.



**CHRISTMAS PLATES AND MATS.** An exclusive Fifth Avenue shop features yearly its famous Christmas Tree fine china. Now, for mere pennies, you can add the same holiday touch to your table with these good looking plastic plates with hard, chinalike finish. 9 1/2", washable in hot water. 8 plates and mats, \$3.25. Set of 8 plates only, \$1.75 ppd. The Added Touch, Dept. E, Wynnewood, Pa.



**MAKE LIGHT WORK** of shoveling snow with Rid-O-Sno. Scientifically designed, this plow with its 30" adjustable blade, rolls along on rubber tires, saves your heart, back and energy. All you do is guide it. Of heavy duty steel, it's a long-term investment in health. \$18.75 ppd. (add \$1.00 w. of Miss.) Leisure Industries, 96-09 Metropolitan Ave., Forest Hills 75, N. Y.

You've ample time to order for Christmas. from these pages and avoid crowds. But act promptly.

## 62 BALLOONS \$1 THAT MAKE GIANT CIRCUS ANIMALS

GREAT FOR PARTIES, Instructions Included. 124 BALLOONS \$1.75—Packed in decorative Xmas stocking. ADD 10c POSTAGE PER ORDER. Circus Balloons, Dept. 5, Scarsdale, N. Y.

## STOP RADIO & TV NOISES INSTANTLY



NEW PATENTED ELECTRONIC INVENTION "CLEAR TONE" filter eliminates noisy interferences caused by all motor appliances, autos, oil burners, etc. Simply plug radio or TV cord into filter and filter into wall socket. Enjoy "CLEAR TONE" reception. Try 5 days—MONEY BACK GUARANTEE. SEND 10c for postage handling. Household Prod., Dept. 5, Scarsdale, N. Y.

## SENSATIONAL KNIFE SHARPENER



Makes Knives RAZOR-SHARP in 30 seconds or CASH REFUNDED! Now Sharpen all your knives, scissors, axes, lawn mowers, garden tools in a flash! This new combination sharpener and glass cutter is clearly marked with correct cutting angle for each tool. Sells on TV for \$1.98. OUR PRICE... **\$1.00** SEND 10c for postage, handling. 2 for \$1.75 Scarsdale PRODUCTS, Dept. 5, Scarsdale, N. Y.

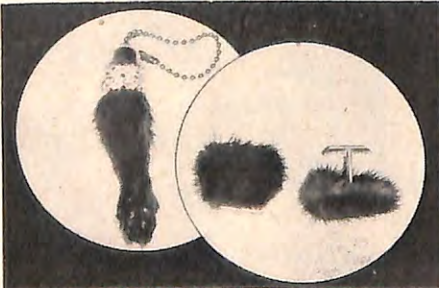

## You Too Can Give Mink This Christmas

Everybody loves mink... and these genuine Mink Cuff Links and Rhinestone Jeweled Mink Paw Key Chains, designed by Vison-Patte are sure to thrill your very special friends who have "everything." Both Key Chain and Cuff Links are available in Natural Dark Brown, Grey, White, Pastel and Silver Blue. Gift Boxed. Only \$3.95 for the Cuff Links or Key Chain, \$7.50 for the Set. Money Back Guarantee. Check or Money Order we pay postage. Calif. residents add 4% tax.

**INCE-SIEGEL CORP.**

706 S. Hill St. Los Angeles 14, Calif.

# SHOPPER



**YOU'LL WANT TO CROW** at the value in this Wind Master Weather vane. Big, well-designed and of rust-resisting steel, it's comparable to vanes at more than twice the price. 29" high, 28" wide. Sensitive to the slightest change in wind directions. Partially preassembled. A charming gift for the house-proud. \$8.95 ppd. Racine Specialty Mfg. Co., 1309 State St., Dept. E, Racine, Wis.



**HOUSEHOLD SCREWDRIVER SET** includes: a metal wall rack, two vials of bright-finish assorted household screws plus 6 screwdrivers: Mechanic's Driver; long-blade Driver with "Screw Holder"; Phillips-type Driver; thin blade for electrical work; stubby Driver; Fine Works Driver. All blades magnetized, unbreakable plastic handles. \$1.50 ppd. Terry Products, Box 581-E, Merrick, N. Y.

## The WATCH FOR ACTIVE MEN

### 17 JEWELS WATERPROOF Anti-Magnetic

Here's one of the greatest watch values ever offered. Rugged and good looking, this 17 jewel precision timepiece is shock-proof and rust-proof, and has sweep-second hand, radium dial, unbreakable main spring. Smart steel expansion band with luxurious lizard insert. Complete with handsomely lined leatherette case. Guaranteed for one year.



Reg. \$49 Value \$19.95

Send check or M.O. Money back in 10 days if not thoroughly delighted.

Fed. Tax included

**BELDNER WATCH CO.** Dept. E, 1568 E 7 St. BROOKLYN 30, N. Y.

## IMPORTED SOLINGEN CARVING SET

Famous make 3-piece stainless steel set, genuine stag handles; 7 1/2" forged razor-sharp blade, fork with guard. Complete in leatherette silk-lined gift box. \$9.95 ppd. Please endorse check or money order. Pre-Xmas delivery guaranteed on orders received by Dec. 15th. **HENLEY & CO., Inc.**, 27 Spruce Street, New York



**A CHEST TO TREASURE** from Sorrento is this little gem of Italian handiwork. The inlaid cover is made of tiny, handcarved multi-colored pieces of wood. Divided compartment holds cards, cigarettes, trinkets. Below is a pullout drawer. 6 1/2" long, 4 1/2" wide. \$3.95 ppd.

### ITALCO IMPORTING

1498 Pitkin Ave. Brooklyn 12, N. Y.



## Santa's Best Gift for Your Dog

One sniff of this colorful doggy gift box, and your pet will know it's for him! Give your dog luxurious comfort, relief from scratching, restful sleep in its soothing cedar aroma. Kills fleas and doggy "B.O." So enticing he'll forsake chairs and sofa. Long-lasting. **Flea-Scat-Pad**, 15x28 in. \$3.49; Super size, 28x36 in. \$4.98.

**Kitty Coote-Chaser** the Pad for Cats—hear pussy purr in luxury and revel in the catnip aroma of this comfortable bed. Kills fleas and lice. 14-18 in. \$2.49.

**SEND NO MONEY**—Order C.O.D., or send check, and we'll pay postage. **Money-Back Guarantee.** **SUDBURY LABORATORY, Box 295, Sudbury, Mass.**



## Personalized CHRISTMAS RECORD

**Santa Talks to Your Child ... and Calls Child by Name!**

... ONLY \$1.00

Imagine the thrill "small-fry" will get when they hear Santa speaking DIRECTLY to him (or her) personally, by name. Santa talks about being good, talks about the joys of Xmas, discusses his reindeer, etc. See how excited youngsters get when they can join in singing Jingle Bells with Santa.

**Satisfaction Guaranteed or Money Back** Each record is individually recorded, specially processed with ANY name. Plays on any phonograph. Unbreakable plastic; play it repeatedly, year after year. Buy several Records as gifts. State child's name. Add 15c to each Record ordered for postage and handling. No C.O.D.'s please. **Order shipped same day received.** **BANCROFT'S, 1112 S. Wabash Ave., Dept. EL-661, Chicago 5, Ill.**

## CUCKOO CLOCK



from GERMAN BLACK FOREST

Now \$3.95 only

postpaid ... duty-free

Direct to you from EUROPE

Low price only by direct import. German weight and pendulum CUCKOO CLOCK.

Excellent timekeeper. Cuckoos every quarter hour. **HAND CARVED.** Antique walnut finish. Shipped direct from Free Europe with strange foreign stamps. Order as gifts, too. (Not more than one addressed to the same person.) Send only \$3.95 each. No COD's. Postman collects 15c foreign packet fee which can't be prepaid. Money-back guarantee. Order today.

**SEVEN SEAS IMPORTS, Dept. E39C**

1717 Westwood Blvd., Los Angeles 24, California

## AMAZING NEW PIPE ... THE IDEAL GIFT!



**wagär** Patents Pending

**TARS TRAPPED in the FILTER, Can't Reach the Lungs**



### SMOKERS LOVE IT!

Can't spill hot ashes!  
Smoke in wind or rain!  
Can't burn clothes or automobile upholstery!

Tomorrow's Pipe ... Today! Provides clean, DRY, cool smoke MINUS THE HOT TOBACCO TARS that normally go into the lungs. Remarkable lifetime "cooling tower" condensing filter traps the tars to be wiped off the filter with a tissue. A WONDERFUL GIFT for any man! \$5.00 postpaid. Prompt shipment. Order from **WAGAR PIPE, P. O. Box 2321, Houston, Texas.**

## Golfers WHAM-O for practice

**NEW!** GROOVE YOUR SWING AT HOME!  
DEVELOP FORM - CORRECT HOOK AND SLICE!



USED BY PROS

\$1.95 post paid

**No ball to chase!** Simply push into ground and hit. Returns to position after club swing. Hooking, slicing, or topping is indicated by action of Wham-O. Practice just 5 minutes a day with our instructions and play 100% better on Sunday! Folds to 8" for golf bag. Use to warm up at starting tee. Tough pliable plastic, ash hardwood stock, 3" steel spikes. Withstands violent abuse. Only \$1.95 complete. Satisfaction Guaranteed. Ideal for gift. Send to: **WAMO MFG CO., Box 62 R, San Gabriel, Calif.**

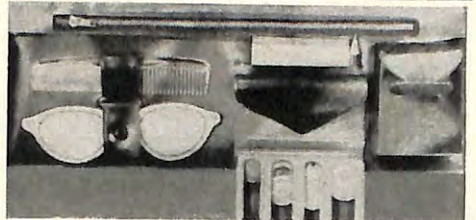

## VISOR-ALL—Perfect gift for drivers

Holds everything needed for quick use: Pocket with closed cover for cigarette pack • Eyeglasses holder • Handy pencil and pad • Completely closed coin holder • Easy-to-reach comb • Extra-large map pocket • Full length zipper wallet pocket • "Easy-tack" clips hold Visor-all securely to any car visor. \$2.98 ppd. FREE with every order postmarked before Dec. 10: Box of gift wrap assortments (value \$1.00)

**MARIE ADAMS, Box 132, Canton, Maine**

## You will ENJOY pleasant, vigorous VIBRATORY MASSAGE

with the Genuine Battle Creek

**HEALTH BUILDER**



"TOPS" for the Home, for Athletic Clubs, for Reducing Salons—for MEN and WOMEN!

Enjoy the relaxing, stimulating benefits of efficient vibratory massage! Health Builder gives you pleasant, scientific deep-tissue manipulation—"at the snap of a switch." Helps weight and figure problems, muscle-toning, blood circulation. Widely used in Health Institutions. Built for years of service—fully guaranteed. WRITE today for literature and new booklet, "BE GOOD TO YOURSELF!"

**Battle Creek EQUIPMENT CO.**

BATTLE CREEK 11, MICH.



with Ed Faust



# In the Doghouse

**You can diagnose distemper if you know the symptoms—but treatment is for a vet.**

I HAD COUNTED ON A CHEERFUL VISIT with Jim and his pretty wife and some good food, too, because the aforesaid queen of my friends' affections was an artist of no small ability with a skillet. Aside from my own home, it was one of the few places where I could be sure of what went into the hash. But when I arrived the gloom was almost as tangible as a fog. The cause was the death of their dog, a pet which they had cherished for years. Had I not a deep fondness for them, instead of sympathizing, I would probably have said to myself, "It serves you right." But at such a time you don't say things like that to people you really like.

"Ed, he was more than just a dog to us; why, it was as if he belonged to the family".

Now I've heard this said before and my reaction has invariably been, "All right, you now say you thought of your dog as a member of the family, then why, when you clearly knew you had a sick dog on your hands, didn't you take 'him' to a dog doctor? Would you have withheld proper medical attention from a human member of the family, just to save a few dollars? Of course you wouldn't". Veterinarian fees are by no means excessive and the small savings might mean life or death for the dog.

This is not an exaggerated case but one that any professional dog writer will confirm. It is amazing to what lengths some people will go to try to save a few dollars by home doctoring a dog. Barring infants, any adult or child who can speak can tell what hurts and where. But a sick dog can only lie in misery wholly dependent upon the compassion of its master or mistress who sometimes will try any home remedy that suggests itself, or is recommended. Equally amazing is the surprise of the owner when his pet dies. Only a skilled vet can properly diagnose the sickness of a dog and even then, because of the dog's inability to talk, there are times when the vet has to indulge in a little guesswork. However, with the great advances made in animal pathology and, still are being made, more and more the treatment of dog sicknesses is becoming better understood.

My friend Jim, an otherwise kind, considerate and intelligent man, waited until it was too late to take his dog to the vet.

Result: he and other members of his household are inconsolable. The only suggestion I could have made but withheld was to get another dog and get one soon. But then, as the vet had told Jim that his dog was a victim of distemper, I advised that he consult the vet as to when it would be safe to introduce another dog into the home. I'm of the opinion that my stock has fallen a bit as my counsel was regarded a bit on the callous side.

**D**ISTEMPER is one of the most contagious diseases afflicting dogs. Unfortunately, it is all too common. It is believed that with few exceptions nearly all dogs, unless they are isolated from other dogs and animals, are exposed to distemper virus. Its symptoms generally resemble those of human influenza, although other symptoms may prevail. The best safety measure is to have the dog inoculated with serums of vaccines. Any competent veterinarian can give the in-

oculations and they are very helpful.

There are two methods of inoculation. One is the one-shot treatment which confers temporary immunity to a degree; the other, and more lasting, is the three-inoculation method. Frequently, kennels when advertising their dogs, state that they have been distemper inoculated, but this may mean only that the dog has been given the one-shot treatment. The reputable kennel will not mislead the buyer into thinking that the three-inoculation method has been employed. Nor will such a kennel advertise inoculated dogs when the shot hasn't been given. There are many kennels that do not inoculate their dogs since they do not have the necessary equipment or skill and are reluctant to spend money for vet fees on dogs they offer for sale. For this the kennel cannot be criticized. After all, once the buyer takes possession of the dog he is entirely responsible for its well-being and health.

*(Continued on page 52)*

Photo by Yila

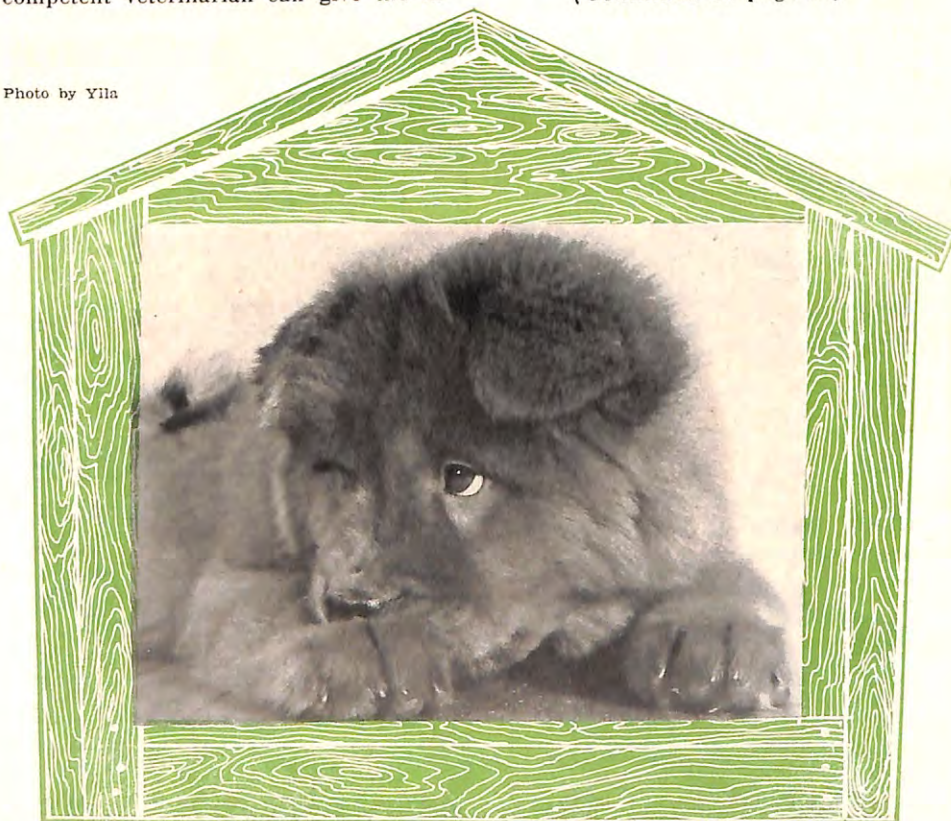

This healthy looking Chow Chow is not worried about distemper. The Chow is of ancient ancestry and was known in China more than 2,000 years ago.



everywhere and always ...  
 it's American whiskey at its finest

Year after year wherever people gather in America—in our greatest cities and smallest communities—7 Crown makes and keeps more friends than any other whiskey in history. There is one reason for this: Americans prefer its distinctive character—its rich flavor, smooth without a trace of heaviness. Truly the finest taste in American whiskey!

Say **Seagram's** and be **Sure**



SEAGRAM-DISTILLERS COMPANY, NEW YORK CITY. BLENDED WHISKEY. 86.8 PROOF. 65% GRAIN NEUTRAL SPIRITS.

## ELK LEADERS ATTEND SERVICES FOR PGER CAMPBELL



Grand Exalted Ruler John L. Walker and seven Past Grand Exalted Rulers on October 3rd attended the services in East St. Louis, Ill., for late Past Grand Exalted Ruler Bruce A. Campbell. Left to right at the Services are: Past Grand Exalted Rulers Earl James, Henry C. Warner, John F. Malley, John S. McClelland, the Grand Exalted Ruler and Past Grand Exalted Rulers Joseph B. Kyle and James R. Nicholson. Past Grand Exalted Ruler Floyd E. Thompson attended the services but was unable to be present for this photograph.



A timely note from Benjamin Washastrom, P. E. R. and present Secretary of New Orleans Lodge No. 30, reads in part, "Mardi Gras comes early this year, beginning on February 14th. At this time we have received letters from several out-of-town Elks who advise that they have been unable to obtain reservations at the hotels for the event. We have, of course, made arrangements to secure the best accommodations available for all inquiring Brothers, but it would facilitate matters if we heard from interested members as early as possible." He suggests that members avoid the last-minute rush, if they plan to visit New Orleans at Mardi Gras time.

★ ★ ★

*The Freedom Bell, which hangs in the tower of Schoeneberg Town Hall in West Berlin, was five years old on October 24th. This bell, modeled after the Liberty Bell,*

*was a gift to the people of Berlin from the people of America and the names of the 17 million contributors registered on scrolls will be deposited in a shrine adjoining the belfry. The bell rings for two minutes at noon every day, and its tones reminds everyone on both sides of the Iron Curtain of the principles of Freedom.*

★ ★ ★

Phoenix Chamber of Commerce announces that a new \$150,000 stadium, where the Baltimore Orioles will train next Spring, is nearing completion at nearby Scottdale. The Giant, Cubs and Indians, all of whom also train in Arizona, will give visitors to the "Valley of the Sun" plenty of "Cactus League" baseball next Spring.

★ ★ ★

*A World's Trade Fair in the United States is scheduled for April, 1957. It will be held at the New Coliseum now under construction at Columbus Circle, 59th Street, in New York City.*

★ ★ ★

The first of two Hawaiian all-expense cruises aboard the luxury line "Lurline," announced by the Matson Line, sailed in November. The second will leave San Francisco shortly before Christmas. Fares begin at \$337.50.

★ ★ ★

*And speaking of winter cruises, the*

*Cunard liner "Mauretania" will make six West Indies-South America "Sunshine Cruises" during the Winter. Tours range from 7 to 17 days, with the first leaving New York on December 22nd on an 11-day tour over Christmas and New Year. Minimum rate is \$280.*

★ ★ ★

Self-claiming baggage service now is in effect at 23 stations of United Airlines. Instead of presenting checks to porters, arriving passengers pick up their own baggage from open racks. Checks are turned in upon leaving the baggage claiming area. By this method baggage is picked up 50 per cent faster than by the traditional and often inconvenient porter-fetching method.

★ ★ ★

*If you are on your way to Europe, you may be interested in the river cruises on the Shannon in Ireland. The new steamer "St. Brendan" makes the run and explores cities and counties along the beautiful River Shannon. The "St. Brendan" leaves daily from Athlone, Carrick-on-Shannon or Killybegs.*

★ ★ ★

The first eastbound trip from New York of the new "S. S. Israel" of the Zim Navigation Company's fleet began on November 4th. The journey, via Gibraltar and Naples, takes about fourteen days. The "Israel" is the fleet's flagship and has accommodations for 313 passengers in First Class and Tourist quarters. It features all outside staterooms and air-conditioning in First Class staterooms. As soon as a sister ship "S. S. Zion" is in commission about February 1956, the Zim Line will offer sailings to Israel every three weeks.

★ ★ ★

*The tourist card for visitors in San Salvador, Central America, is now free and is good for 90 days. Cards will be available to travelers who enter the country as temporary visitors for recreational purposes and who are residents of American and European countries with whom San Salvador maintains official relations. These cards for tourists wishing to visit San Salvador may be obtained from travel agents and transportation firms.*

★ ★ ★

The Cumberland Gap National Park was established on September 14th this year and its 20,100 acres make it the largest historical park in the United States. Its site extends from the outskirts of Middleboro, Kentucky, to Cumberland Gap, Tennessee. The land is rich in history and was contributed by Kentucky and Tennessee.

## Visiting the Lodges with John L. Walker

(Continued from page 9)

Anniversary banquet, held at the Hotel Northampton. It was attended by more than 250 members and guests. The Grand Exalted Ruler, in his address to those present, spoke eloquently of the many contributions that Northampton Lodge has made to the Order since its institution 50 years ago. The program also fea-

tured addresses by Lt. Gov. Sumner Whittier, District Deputy William A. Ouimet and Exalted Ruler Harry Jekanowski.

The following morning the Grand Exalted Ruler and his party of New England Elks visited GREENFIELD LODGE, where they were greeted by Exalted Ruler Herbert F. Sauter. With Mr. Walker were Past

Grand Exalted Rulers John F. Malley and E. Mark Sullivan, Grand Treasurer Edward A. Spry, John B. Finck, President of Vermont State Elks Association, and District Deputy Raymond J. Quesnel. From there, the Grand Exalted Ruler traveled to BRATTLEBORO, VT., LODGE, where he was the honored guest at a



luncheon, with Exalted Ruler Harold L. Webster acting as host.

On September 28th the Grand Exalted Ruler and his group visited **WINDSOR LODGE**. After being shown around the lodge by Exalted Ruler Hugh Goodwin, Mr. Walker complimented the lodge for its fine quarters.

The following morning the Grand Exalted Ruler was met by a group of officers of **LITTLETON, N.H., LODGE** at the Vermont boundary and was escorted to Littleton, where he was greeted by Exalted Ruler William C. Judge. In Mr. Walker's party were Past Grand Exalted Ruler John F. Malley, Grand Treasurer Edward A. Spry, District Deputy Edward Govan-geli and Past District Deputy Ben Hopkins.

Later the Grand Exalted Ruler and his party attended a luncheon given at the Montpelier, Vt., Country Club in honor of Mr. Walker. Present at the luncheon were Armand Beltrami, Exalted Ruler of **BARRE LODGE**, and A. E. Wingrove, Exalted Ruler of **MONTPELIER LODGE**.

After leaving Vermont on Sept. 29, the Grand Exalted Ruler proceeded to New Hampshire to visit **LACONIA LODGE** on that same day. At a luncheon where he was the guest of honor Mr. Walker praised the lodge for having the largest membership in the state. Among Elks welcoming Mr. Walker were Exalted Ruler Francis H. Riel and Past Exalted Ruler Maurice Jacques.

On October 2nd the Grand Exalted Ruler visited Providence, R. I., where under the auspices of the Rhode Island State Elks Assn., he was tendered a reception and dinner at the Sheraton Biltmore Hotel. With Mr. Walker and his wife at the speaker's table were Governor Dennis J. Roberts of Rhode Island; Past Grand Exalted Ruler John F. Malley; Judge John E. Mullen, Past Chief Justice of the Grand Forum, and Mrs. Mullen; Judge John E. Fenton, member of the Grand Lodge Judiciary Committee; John W. Moakler, President of R. I. State Elks Assn., and Mrs. Moakler; District Deputy Richard A. Moran and his wife; Past District Deputy James F. Duffy, Jr. and Raymond J. Nottage, a Trustee of Providence Lodge.

Following this visit the Grand Exalted Ruler flew to San Diego, Calif., to attend the California State Elks Convention, as reported elsewhere in this issue. After the Convention, Mr. Walker went to Montana, where, on October 10th, he visited **GREAT FALLS LODGE**. While there Mr. Walker particularly praised the Montana State Elks Assn.'s new program of sponsoring speech and hearing therapy traveling units in their state. The Grand Exalted Ruler had the opportunity to inspect one of the units while in Great Falls. The unit, a station wagon completely equipped for its work, was driven from its headquarters in Billings by the director of Speech and Hearing of the Montana Crippled Children's Society. The project is sponsored by the Montana Elks

**Since 1926! The Halvorfold**

Loose-leaf Pass Case, Billfold, Card Case. Note exclusive features. Read Special Offer below

**"Made to Order" for ELKS**

**Free Examination!**  
**Send No Money—Pay No C.O.D.**

Means exactly what it says. No strings. Mail coupon. Halvorfold comes by return mail. Examine it carefully. Slip in passes and cards. See how handy it is. Show it to your friends and note their admiration. Compare it with other cases at more money. I trust Elks and all the Mrs. Elks, who buy annually, as square-shooters. And I am so sure the Halvorfold is just what you need that I am making you the fairest offer I know how. Send coupon.

**FREE** in 23K Gold. Name, Address and any Emblem. Would ordinarily cost \$2.50 extra. Ideal Gift with friend's name and any fraternal emblem.

**HALVORSEN, P.C.M.—STATION G, JACKSONVILLE, FLORIDA, Dept. 74**

Send Halvorfolds for free examination as per instructions below. If I decide to keep them, I will send check at once. If not, I will return merchandise in three (3) days and call the deal closed. (Halvorfolds come regularly for 8 passes. For 12-pass add 25c, 16-pass 50c, etc. Check squares and PRINT Gold Engraving instructions).

Name: ..... 23K Gold Inside Emblem: .....

Address: .....

5% off to save bookkeeping. If you prefer to send cash with order. Money back if not satisfied.

Please check here:  black  brown Morocco \$5.00—Smooth  black  brown Calfskin \$7.50  Special gold filled Corners and Snap Fastener (extra protection and beauty) \$1.50 additional. Outside embossed emblem:  ELK  MASON  EAGLES  MOOSE  KNIGHTS OF COLUMBUS.

under the administration of the Crippled Children's Society. The Grand Exalted Ruler was so emphatic in his praise of the project that he was the subject of an editorial in the Great Falls "Tribune," which lauded him and Elkdom. Said the Tribune, "In this and in other welfare and charity work, they are exemplifying the fine traditions of their Order." Mr. Walker was interviewed by local radio station KMON while in Great Falls.

The Grand Exalted Ruler attended a luncheon at the Great Falls Lodge and then drove to **HAVRE LODGE** that afternoon. He was accompanied by C. P. Miryr, President of the Montana State Elks Assn., W. L. Hill, Past Grand Tiler, L. G. Seymour, Exalted Ruler, Henry Angemier, Secretary, and George LeRoux, State Chairman of Publicity, all of whom are members of Great Falls Lodge. Representing other parts of the state were District Deputy Lowell Paige of **VIRGINIA CITY LODGE**, Exalted Rulers Wilbur Warner of **CUT BANK LODGE** and Manley Kirkeby of **SHELBY LODGE**. In Havre, the Grand Exalted Ruler received an enthusiastic welcome at a banquet held in his honor. Exalted Ruler C. J. Matthews was master of ceremonies.

From Havre, the Grand Exalted Ruler was escorted on Oct. 11 by car to **GLASGOW LODGE** for an afternoon luncheon and an inspection of this newest of Montana lodges. In the evening Mr. Walker

attended a meeting at **WOLF POINT LODGE** where he witnessed the presentation of a check by Exalted Ruler L. M. Clayton toward the maintenance of the Montana Elks Speech and Hearing Therapy project. A similar presentation was made the following day, Oct. 12, at **SIDNEY LODGE**, the last of the Montana lodges visited by the Grand Exalted Ruler. Among Walker's hosts at Sidney were District Deputy Chet Johnson and Exalted Ruler Cyril Little.

Later that day the Grand Exalted Ruler began a trip through North Dakota and was accompanied by Past Grand Exalted Ruler Sam Stern, District Deputy F. H. Gilliland, President A. C. Moore of the North Dakota State Elks Assn. and State Assn. Trustee Frank V. Archibald and Frank Cheatham. On a portion of the trip Ray Dobson, Past State Assn. President, was also a member of the official party. First visit in North Dakota (Continued on page 50)

Grand Exalted Ruler's Itinerary*	
Nov. 22	Roanoke, Va.
Dec. 4	Chicago, Ill.
5	Kenosha and Milwaukee, Wisc.
6	Williamsport, Pa.
7	Tamaqua, Pa.
8	Waynesboro, Pa.
10	Red Lion, Pa.
20	Roanoke, Va.

\*Subject to change

# A Family Affair

The 1955 selection of photographs sent us by lodges whose installation ceremonies saw members of the new leaders' families participating either as officials *pro tem*, or proud spectators.

In South Orange, N. J., 25-year-Elk Fred H. Wuethrich, right, saw his son, Willard O. Wuethrich, second from left, installed by another son, P.E.R. Fred J. Wuethrich, third from left. At left is retiring E.R. Wm. H. Walker.



G. Philip Stone, right, E.R. of Danbury, Conn., Lodge, received his gavel from his father, John J. Stone, P.D.D., and long-time lodge Secretary.



Iron Mountain, Mich., Lodge's 1948-49 E.R. Russell J. Bath, congratulates its 1955-56 Exalted Ruler, his son David R. Bath.

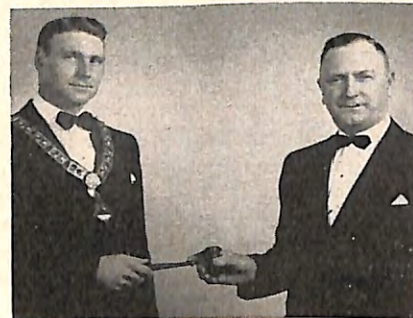

E.R. of Ann Arbor, Mich., Elkdom only three years ago, Harry E. Cooch, right, installed his son Theodore E. Cooch as this year's leader.



West Haven, Conn., E.R. Hugh C. Graham, left, was congratulated by his father, Hugh M. Graham, right, when he received his gavel of office from P.E.R. Edward P. Farrell.



When Reidsville, N. C., Lodge was instituted in 1947, Alex S. Johnson, left, was elected its first E.R. This year he conducted the ceremony installing his brother Robert as Exalted Ruler.



The Rocky Mount, N. C., ceremony saw D.D. Norman Gold, right, congratulating Norman Y. Chambliss, Sr., left, as Exalted Ruler, and Norman Y. Chambliss, Jr., as Secy. of the lodge.



Fred A. Doman, a former E.R. of Ottawa, Kans., Lodge, left, installed his son Howard F. Doman as their lodge's 1955-56 Exalted Ruler.



Placing the badge of office on Sedalia, Mo., Lodge's E.R. James E. Durley is his fraternal and natural brother, P.E.R. L. H. Durley.



P.E.R. William E. Grady, right, presided at the Chillicothe, Ohio, installation of his brother, Herbert Eugene Grady, as Exalted Ruler.



Left: Thirty years ago, P.D.D. Desmond J. O'Neil, right, served Glendive, Mont., Lodge as E.R. This year he enjoyed the privilege of installing his 29-year-old nephew, Thomas J. Cavanaugh, in that office.



Right: Laramie, Wyo., P.E.R. Walter Klahn, Sr., handled the installation of his son when Walter, Jr., became the lodge's 1955-56 leader.

## A Face Next Door

(Continued from page 5)

bad news for you."

She was small and slim and fair, and now she sat on the sofa, drying her hands on her apron. She said, "All right, Harry. What is it?"

How could you say it gently? But he tried. "I'm going to be arrested tonight."

And she tried to smile, but it was a pitiful effort. "You're joking, Harry. A parking ticket?"

He said, "No", and saw the old fear walk into her eyes. The fear that had been so bright in them once before and which had gradually faded until it had disappeared.

A long moment passed before she said, "It was so far away and so long ago."

He nodded, his thoughts going back to that town in another state where unhappiness had haunted them. The firm he'd been working for had shut down, and it had been the City's single big industry. Kate had been sick, and Ned, only a year old, had been sick. So you used what money you had, and then you used the unemployment insurance, you borrowed on your life insurance, and you borrowed what you could from friends almost as broke as yourself. And the bills continued to be much more than you could handle.

So one night he had broken into the

### JUDICIARY COMMITTEE ASSIGNMENTS

Chairman William S. Hawkins has assigned to the members of the Grand Lodge Judiciary Committee specific items to be handled by each in the accomplishment of Elkdom's judiciary work.

Lodge Secretaries are urged to make note of this information in order to avoid delays in communicating with the proper Committeeman on any given subject. It is further suggested that, in contacting these members, all necessary correspondence and other material pertinent to the matter in question be attached.

Opinions and Decisions: Chairman Wm. S. Hawkins, 320-321 Wiggett Bldg., Coeur d'Alene, Idaho.

By-Laws and House Rules: John E. Fenton, Land Court, Pemberton Square, Boston 8, Massachusetts.

Corporation By-Laws, including By-Law Amendments for Incorporated Lodges: A. F. Bray, 422 State Bldg., San Francisco 2, California.

Building Applications: Jay H. Michigan.

Payne, Court House, Ann Arbor, Bulletin and Publications: Jacob L. Sherman, 624 University Bldg., Denver, Colorado.



My  
master  
gives  
**MELROSE**  
RARE

In this beautiful new GIFT  
DECANTER at no additional cost

Let this clever puppy remind you to give  
your friends "the very best" whiskey . . .  
Melrose Rare! In its elegant new Gift  
Decanter it makes the giving part of the  
Holidays the very best part!

BLENDED WHISKEY, 90 PROOF, 40% STRAIGHT WHISKIES 7 YEARS OLD, 60% GRAIN NEUTRAL SPIRITS  
MELROSE DISTILLERS CO., NEW YORK

### FOR YOUR MEETING...

ASK FOR OUR  
*Interesting*

**FILM**  
IN  
COLOR

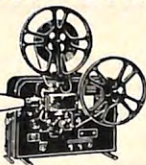

Mr. Program Chairman: Let us furnish our interesting Color Film for one of your Programs, free of charge. It's a 20-minute 16mm, sound movie, approved by Youth Development Organizations. Films are available to be shown anywhere in the U.S.A.

Write for reservations.

**TANDY INDUSTRIES, (Home Office)**  
P. O. BOX 791-RT • FORT WORTH, TEXAS

**Elks!** FOR ALL  
MEMORABLE OCCASIONS  
**BRONZE PLAQUES**



Say it better . . . Say it forever . . . Say it for less  
U. S. Bronze leadership in quality and artistry is forever impressing everybody everywhere, and low prices keep our customers pleased, too. Write now for new complete FREE color catalog and information — helpful suggestions for honor rolls, awards, memorials, testimonials, for everything. Write to

"Bronze Tablet Headquarters"

**UNITED STATES BRONZE SIGN CO., Inc.**  
570 Broadway, Dept. E, N. Y. 12, N. Y.

## FREE... Beauty Booklet Aids Hard of Hearing

"Can I wear hearing aid without dangling cord?" "Must I 'advertise' my hearing loss?" "Do I have to wear a bulky hearing aid?" Now, new



booklet "Beauty Secrets" reveals in words and photos how you can correct your hearing loss in new, inconspicuous way. Don't let strained hearing add lines to your face—"years" to your age. Enjoy the natural way of hearing again

with wonderful new way of hearing correction. Amazing new booklet tells clearly how you may share the "world's best kept beauty secret". Write today for your booklet sent in plain envelope.

Maico, Inc., Room 16U 21 North Third St.  
Minneapolis 1, Minn.

Please send me, free and without obligation,  
your booklet, "New Beauty Secrets for the  
Hard of Hearing Lady".

Name \_\_\_\_\_  
Address \_\_\_\_\_  
City \_\_\_\_\_ Zone \_\_\_\_\_ State \_\_\_\_\_

# "FREEDOM'S FACTS"—Reds Fear Exposure



Some time between now and next summer the U. S. Supreme Court is expected to make a decision which will profoundly affect the fight against communism in the United States.

Officially, the case is listed as the Communist Party of the United States of America versus the Subversive Activities Control Board. Actually, it involves an appeal by the Party from an SACB order directing that it register itself and its members under the Internal Security Act of 1950.

The order was issued by the SACB in 1953. The U. S. Court of Appeals upheld the order by a two to one vote in December 1954, and now the appeal has reached the Supreme Court. If the Supreme Court upholds the SACB order, the Party will be forced to register itself and all of its members within thirty days following the decision, or face penalties up to \$10,000, each day of non-compliance counting as a separate offense.

If, on the other hand, the Supreme Court decides against the SACB order and declares that the Internal Security Act of 1950 is unconstitutional, as the

Party is urging, a major sector of the fight against communism will have to be rebuilt.

## What The Act Provides

Essentially, the Act, popularly known as the McCarran Act, requires registration with the Attorney General of all communist-action organizations and their members and of communist-front organizations and their officers. These organizations must file periodic financial statements and identify all their literature. Contributions to them are not tax-exempt.

The Act also set up the SACB as a five-man board appointed by the President to determine whether an organization could be designated as communist-action or communist-front. The SACB acts only on petitions by the Attorney General directing an organization to register.

Hearings on the first petition, involving the Communist Party U.S.A., began on April 23, 1951. On April 20, 1953, the SACB found that the Party acted in all ways as an agent of the Soviet Union and operated on a secret basis to conceal its foreign domination.

On the same date, one of the SACB members pointed out that the purpose of the Act was not to punish or to outlaw the Communist Party, but to publicly identify it and its members as agents of a foreign

government. Many Americans acting as public relations representatives of such countries as Pakistan and Liberia also are required to register as foreign agents.

But conditions are different with conspirators. The Reds, whose primary tactics in the United States are the manipulation of front groups and secret infiltration into non-communist groups, fear exposure in their true light. And the Party is fighting the McCarran Act with every force at its command. The Party claims that the Act regiments speech, press and assembly; censors dissenting expression; suppresses voluntary association; and denies individuals their livelihood.

The "Daily Worker" states, "Anonymity of membership in unpopular groups and especially minority parties is indispensable to freedom of political action." In this one statement the Reds admit that if the American people would identify them, their political effectiveness would be largely destroyed.

The foregoing is from the current issue of "Freedom's Facts," a monthly bulletin prepared by the All-American Conference to Combat Communism. The BPOE is one of fifty national organizations with membership in the Conference and, because of the important anti-communist writing in "Freedom's Facts," is publishing excerpts each month.

big gas station on the edge of town. It had been ridiculously simple. A jimmyed window, a cash box that invited opening, and five hundred and fifty dollars. After that it had been simply a flight from their small furnished apartment, putting what personal belongings they could into the old car. And because they had been a small, inconspicuous family and there had been no reason to suspect him, they had travelled far.

He remembered that night on the road,

when he had told her why they were leaving, and what he had done, and why they had to change their name. She had sat in the moving car for ten minutes without speaking, and then she had said dully, "All right, Harry," and had never spoken of it again. But the fear had been heavy in her eyes.

Kate's hands were still wrapped in her apron. "How did they find out, after all this time?"

He told her of the circumstances of the

last evening. "I was as surprised as Joe to see the picture. I can't figure out how they got it or how they connected me with the thing. But they did."

His wife leaned back tiredly. "It's been good for us here, Harry."

He nodded without speaking. It had been very good. They didn't have much money and they would probably never have a great deal, but they had enough. He had worked up to a nice job and he knew he could keep it as long as he wanted to. All of which had been true up until last night. The kids liked Hill City, and there was Rotary, and he was chairman of the Community Chest. There was the church, and the bowling club . . . but what was the use of continuing the litany?

His wife said, "How could Joe Moran do anything like that to you? You go on fishing trips together. He's Lucy's godfather. You play cards together once a week. My God, they eat here, and we eat in their house!"

"You know what Joe is like. That's one reason we like him so much. He's right off the top."

"I can't believe it," his wife said.

Hamilton sat there for a moment. Maybe Joe Moran wouldn't blow the whistle. Maybe these good years they had shared so closely would make the difference. Maybe. But he didn't think so. He got up.

## INSTRUCTIONS FOR SUBMISSION OF ELK MEMORIAL SUNDAY AND CHRISTMAS REPORTS

Again this year, the Lodge Activities Committee of the Grand Lodge invites the lodges to submit reports on their Elk Memorial Sunday programs and Christmas Charity activities for its consideration as to the most outstanding. The three top programs in each of three groups will be recognized with the presentation of special awards.

DO NOT send material on either of these events to the Magazine.

### ELK MEMORIAL SUNDAY

In accordance with tradition, the memory of Brothers who have passed away during the year will be honored on December 4th.

As soon as possible after that date, photographs and a full account of your program should be submitted to Committeeman Joseph F. Bader, 279 Travers Place, Lyndhurst, N. J.

All reports must be in his possession not later than December 20th.

### CHRISTMAS PROGRAMS

To be sure your lodge's Christmas Charities are given the opportunity to win an award, complete accounts, with photographs, must reach Robert G. Pruitt of this Committee, 808 Southern Railway Bldg., 99 Spring St., S.W., Atlanta, 3, Ga., by January 13th. Details on any Thanksgiving charity programs sponsored by your lodge should also be included with your report.



Hamilton held up a hand. "Whoa! I know what you're going to say, Joe. You don't have to bother."

"I wish I didn't, but. . ."

"I called them," Hamilton said. "Not fifteen minutes ago."

Moran stared at him. "You called who?"

"Your boys," Hamilton said, and his grin was white and sickly in the dusk. "I told them who and where and what and when. I figured I'd save you a little trouble."

Moran was silent for a long moment. "How did you know I recognized the picture?"

Hamilton looked out into the street. "I wasn't positive, but I couldn't take a chance. It would be a hell of a thing, you locking me up." He tried to grin again.

Moran cursed softly. "You're a fool. No one but me would have known that picture. There isn't another guy at headquarters who would. . ."

Hamilton's voice was soft with friendship. "But you would have taken me, wouldn't you, Joe?"

Moran looked at him, then nodded. "Yeah, Harry. I would have had to."

"Sure," Hamilton said. "But I like to

think you wouldn't have been crazy about the job."

"You know all about that," Moran said, and he thanked Hamilton in his heart for not having forced him to hammer home the nails. He said, "What about the money?"

His heart went up three feet when Hamilton said, "I returned it three years ago, when Kate and I took the trip to New York. I mailed five hundred and fifty in bills to the oil company, with a printed note."

Moran's mind was working fast, now. "All right. That's a big thing. I don't think they'll even go to the bother and the expense of extraditing you. And I went to school with the head of the State Police in. . ." He named the state. "He can do a lot of good. And I'll go down and post your bail for tonight." He was beginning to feel a lot better already. "I know a lot of guys on the papers, and I think they'll keep quiet."

Then he saw the plain police sedan coming down the block. It headed in to the curb, and Moran put his arm around Hamilton's shoulder and they walked together to the car. He saw that it was Reese and Deegan, a couple of his own

men. They did not get out of the car.

Moran said, "Harry, you may not know it, but you're a big little man in this town. The Community Chest, the work you did on the hospital drive. You think people forget about things like that? You'll probably never spend a day in jail, and if we're lucky no one at all is going to learn about this."

Hamilton said, "Joe, I don't know how to say it, but. . ."

Moran leaned down to the car window. He said to Reese, "Take good care of my friend, Jimmy. And keep this quiet."

Reese nodded, and Hamilton got into the back seat. As the car drew away, Hamilton said, "Don't forget the mower, Joe."

Moran walked back to his house. Through the intensity of his concentration he became aware of his wife standing on the porch. He patted her shoulder and kissed her on the nose. He said, "It's all right, Nelly. I think everything is going to be all right."

He watched her walk across the lawn to the Hamiltons' place, and then he went inside and started to make the many phone calls. He felt sure that it would be all right.

## The Elks and the Boy Scouts

(Continued from page 17)

land in helping them to become scouts.

The Past Grand Exalted Rulers were Judge James T. Hallinan, James R. Nicholson, and the late Murray Hulbert, Governor David Scholtz and Colonel Charles Hart. The Boy Scouts were represented by Byrnes MacDonald, a member of the National Executive Board of the Boy Scouts of America. It was very fitting that Mr. MacDonald should take part in this meeting as he was known to all the P.G.E.R.'s as the man who conceived of, organized and promoted the Police Athletic League during the administration of Fiorello La Guardia as Mayor of New York City.

I was there in my capacity as the National Director of Civic Relationships of the Boy Scouts of America. In this position it was my duty to act as liaison officer between the Boy Scouts of America and the heads of all the great civic organizations, amongst which we considered the Elks one of the most important.

Somehow or other I knew that the outcome of that meeting would be favorable to the boys of America.

These men represented an organization founded on deep devotion to America, made up of men who themselves had struggled in their early years. Any opportunity that would serve America, and help American boys, would find enthusiastic supporters among the leaders of the Elks.

Sure enough, the outcome was favorable. At the next meeting of the Grand Lodge in Portland, Oregon, in 1947, a resolution recommending the program of

Scouting to all subordinate lodges was passed unanimously.

Things began to happen fast. Lodges over the years had been sponsoring scout troops but there had been no concerted effort to increase the number. At the end of 1945 about 250 lodges were active in scouting; in the next five years this number doubled and at the end of 1954 forty per cent of all lodges were actively and enthusiastically engaged in operating troops.

But this was just the beginning. One of the great stories in the annals of the Boy Scouts of America tells of the attempt of the Local Council in a large southern city to do something for a large number of boys who lived in a Scout District that included the city's downtown area.

It seems that several efforts to get scouting started in that district had failed. One day at a meeting the Exalted Ruler of the Elks Lodge heard the story and offered the help of the lodge. The lodge took over the complete responsibility for the organization and supervision of scouting in the District. At first the going was very tough.

The Exalted Ruler and the Scout officials made an effort to get some of the citizens of the community to become members of the District Committee, and although this is the customary method of organizing a committee, it failed.

At a meeting of the Lodge the matter was brought up for discussion by the Exalted Ruler, and at the end of a very strenuous and informative session the

members decided unanimously to constitute themselves the District Committee.

Then and there, the Exalted Ruler picked six men to be chairmen of the six operating committees of the district, and authorized each one to fill his committee from the members of the Lodge. Finally, he picked one man to be the Scout Commissioner.

Through the enthusiastic support of the members of the lodge and the inspired leadership of the Exalted Ruler, success was achieved. Not alone did they organize the District, but it finally became the best of all the Districts in the council.

This is the only known instance in the 45-year history of the Boy Scouts of America where a single organization has taken over the responsibility for a whole district.

Then there is the matter of finance, and here again the Elks have done something unusual. The program of scouting is operated through Local Councils. The whole of the United States is divided into 540 of these Councils. Each Council raises the money for its operation in the council territory. All the money raised comes from voluntary contributions, from individuals, groups and organizations. Of the many organizations that contribute, the Elks have been among the most generous.

Previous to 1946 the lodges throughout the country contributed about \$25,000 a year. This amount has increased steadily year after year, until in 1954 the amount was estimated to be nearly \$250,000; ten times what it was eight years ago. This is probably the largest amount contrib-

uted by any National Organization to scouting locally.

When a boy talks about scouting—he is thinking of camping. And of course, this is a very important phase of the Scouting program. Nearly every Council in America now owns and operates at least one camp, so that every boy who becomes a scout has an opportunity not alone to have a very economic vacation in camp, but has the opportunity to go to camp as often as he wants for week ends; or other periods.

The purchase, construction, maintenance and supervision of these camps involves a great deal of time and money. Here again the Elks have established an enviable record. In many parts of the country they have taken a leading part in the raising of money to purchase these camps. In many instances not alone have they helped raise the money, but have actually taken an active part in the erection of the buildings on the camp sites.

Once every four years there is a meeting of scouts from nearly all the countries in the world. This is called an International Jamboree. It is the hope of every scout that he will get a chance to go to one of these great events sometime during his scouting career. They are usually held in foreign countries so it takes a lot of money to get there. It is always more than the average boy can afford. There is a danger that only the sons of the rich will get a chance to go. This is avoided by the generosity of various individuals and organizations who contribute some of the expense of sending one or more deserving boys to the Jamboree.

**M**ANY Elks lodges have been instrumental in sending under-privileged boys to many of these affairs. I recall that a lodge in the middle west made it possible for a crippled boy to attend the Jamboree in Austria two years ago. This was a thrilling conference for this lad—it was a very generous act on the part of the lodge.

One of the great problems of the Scouting organization is the matter of making it possible for boys to join. There is no problem of getting the interest of the boys. For instance, this year, about 1,500,000 boys will reach the age of 11—that's when they can become scouts. Of these, one million will express a desire to become scouts, but, and this in my judgment is most unfortunate, only 500,000 will actually be able to join.

This always seems extraordinary to the average person to whom I speak. They don't see why all boys, that want to, can't become scouts. However, when it is explained to them they see the logic of it.

You see, a boy does not simply join the Boy Scouts. He has to join a troop. This troop can exist only when some organization takes on the responsibility of sponsoring it. The job of the scout council or the scout district is to find suffi-

cient number of worthy and competent sponsors, such as fraternal and civic organizations, churches, and schools that will assume this responsibility.

Over 75,000 such groups are now sponsoring scout units. Many of them sponsor two or more, so that at the end of last year there were 97,000 scout units operating. The total number of boys in these units was over two and a half million, and there are 975,000 men who give leadership to these units on a voluntary basis.

Yet, in spite of this, there is still a tremendous need for more sponsors. It is estimated that it is necessary to have 25,000 more troops to meet the demands of boys that now want to come in to the movement.

And, with the boy population increasing at the rate of 7 per cent a year (and so far as we can see this will continue for at least 10 more years), it will be necessary to have 150,000 Boy Scout troops.

Out of this need for many more troops, many plans for recruiting sponsors have been devised. One of the best, and one in which many of the Elks lodges throughout the country have taken the initiative, is called the "Together Plan." Here's how it works. A survey is made of a territory where there is need for a large number of troops. The names and addresses of possible sponsors, such as the churches, schools and civic organizations, are listed. A letter is sent to the heads of these groups, inviting them to send a representative to a dinner meeting where the need is explained; the method of organizing the troops outlined; and they are requested to consider the sponsorship of the unit.

These meetings require a great deal of planning and must be so organized and managed that success is assured. It takes money to finance them. The most successful way to do this is to ask one of the outstanding organizations in the neighborhood to accept the responsibility for the project. Because of their interest in the community, many of those who are asked, and accept, are Elks Lodges.

A lot is being heard now about delinquency. As in all other crises that arise in this country, a lot of foolish statements are being made, as well as a lot of wise ones.

Most people do not pause to analyze what is being said. Many don't even know what the technical definition of delinquency is. When they read about the great increase in "juvenile delinquency," they have visions of a great increase in "criminals." As a matter of fact, the percentage of criminals amongst the modern youth delinquents is not nearly as high as most people imagine. There has been an increase in the number of criminals; there is not much that the average person can do about that; they are the concern of expert criminologists. But what the average person or organization can do is to help the boys who live in or near the



## Monroe FOLDING BANQUET TABLES

Direct Prices & Discounts to Clubs, Churches, Lodges, Schools and All Organizations



### MONROE TRUCKS

For storing Folding Tables and Chairs the easy, modern way. Each truck handles either tables or chairs. Construction of Truck No. TSC permits storage in limited space.



WRITE FOR CATALOG, PRICES AND DISCOUNTS



**THE Monroe COMPANY**  
90 CHURCH STREET, COLFAX, IOWA

## BUY DIRECT FROM-FACTORY SAVE MIDDLEMAN PROFITS

### MASTER MECHANIC PORTABLE LIGHT PLANTS

**Push Button Start—600-700 watts 115 v. 60 cycle, AC. Powered by a rugged 2 hp. easy starting Briggs gas engine. No wiring necessary. Just plug in and operate. Plenty of current for any radio, television, oil burner, freezer, pump, lights, etc. which require up to 700 watts. Ideal for camp, cottage, trailer or boat! Includes voltmeter and built-in winding to charge 6 v. auto batteries. Wt. 75 lbs. Easily fits in car trunk. Be prepared if storm knocks out power lines. Fully guaranteed. Regularly \$275 Special \$143.50**

**1000-1200 Watt Plant (Item 45) same as Item 24 \$199.50 but with larger generator & engine—50% greater output. Send 10c for big 225c Catalog. Free with order. Prices f.o.b. factory. 10 day money back guarantee. Send check or M.O. Master Mechanic Mfg. Co., Dept. 72-L, Burlington, Wis.**



### BOWLING SHIRT EMBLEMS

Official Emblems embroidered in full color.  
3" diameter, per doz. \$ 4.00  
6" diameter, per doz. 15.00

**RUSSELL-HAMPTON CO.**

303 W. Monroe St.

Chicago 6, Illinois



### The Gift for Mother!

Beautifully jewelled cross, cushioned on background of delicately tinted fleecy pearl. A necklace she will love and cherish forever.

Mailed postpaid. Full price \$3.25. Check or money order (Money-back guarantee).

**R. MARTIN • P. O. Box 345 San Francisco 1, California**

## HUNDREDS OF IDEAS for BRONZE PLAQUES

FREE illustrated brochure shows hundreds of original ideas for reasonably priced solid bronze plaques—nameplates, awards, testimonials, honor rolls, memorials, markers.

Write For FREE BROCHURE A For trophy, medal, cup ideas ask for Brochure B.

**INTERNATIONAL BRONZE TABLET CO., INC.**  
Dept. 40—150 West 22 St., New York 11

The gift that says... "Best Wishes"

ALL YEAR... FOR YEARS  
**HULL AUTO COMPASS**  
 NOW ALSO IN  
 NEW CAR COLORS

*Beaconlite*  
 ILLUMINATED \$6.95  
*Streamline*  
 NON-ILLUMINATED \$4.95



The famous, fine instrument name in Auto Compasses.  
 At better dealers everywhere. Write for literature.  
**HULL MFG. CO. P. O. Box 246, EE-II, Warren, O.**

for Xmas give an AIRWAY COMPASS

SELF-LIGHTED—THE PERFECT GIFT FOR A MAN AND HIS CAR

Same guaranteed Sherrill performance that won Army-Navy award! 7 pastel colors: blue, gray, tan, green, white, yellow, coral. FITS ALL AUTOS, BOATS, PLANES. INSTANTLY INSTALLED, NO WIRES

**\$3.98** complete

At dealers, or Sherrill Products, Mexico, Ind., Dept. F95

**GIANT BALLOONS—49c**

They're really BIG—surplus U.S. Govt. (new overage) Neoprene weather, target balloons. GREAT FUN in the backyard at parties, picnics, dances, fairs. TERRIFIC for high school and college PROMS. They attract BIG CROWDS to business openings, civic events, conventions, exhibitions, trade shows. ORDER TODAY! Approx. inflated sizes:

18 in. dia., 3 for 70c  
 3 ft. dia., 49c—5 ft. dia., 99c  
 10 ft. dia., \$1.59

Postage paid on prepaid orders. Calif. residents please add sales tax.

**VOLUME SALES CO., War Assets Division**  
 Dept. E-1255 3930 Sunset Blvd. Los Angeles 29, Calif.

**LAW...**

**STUDY AT HOME** Legally trained men win higher positions and bigger success in business and public life. Greater opportunities now than ever before.

**More Ability: More Prestige: More Money** step by step. You can train at home during spare time. Degree of LL.B. We furnish all text material, including 14-volume Law Library. Low cost, easy terms. Get our valuable 48-page "Law Training for Leadership" and "Evidence" books FREE. Send NOW.

**LASALLE EXTENSION UNIVERSITY, 417 South Dearborn Street**  
 A Correspondence Institution Dept. 12326L Chicago 5, Ill.

**LEARN TO THROW THE BOOMERANG**

A Fascinating Sport and Unique Gift

SEND FOR YOURS TODAY

Flight Tested—Guaranteed to Return  
 Golden Red, Jade Green or Natural  
 with Story and Instructions \$2.00 ea.

**CARVED by Postpaid**  
**COL. JOHN M. GERRISH**

4105-K S. W. Parkview Ave., Portland, Oregon



**NO BETTER GIFT for an ELK**

You could not choose a more appropriate gift for an Elk than a copy of the handsomely bound, 432-page "History of the Order of Elks". It is a book that will delight any member of the Order. It gives the complete history of the Elks from its earliest days and, what's more, gives it in a highly readable, interesting way. In it are 145 illustrations and the book is beautifully printed throughout.

Here in one book are many facts not generally known to many members. Your Elk friend or your lodge library will treasure this authentic record of Elk information. Send for it TODAY. Price \$3.50 plus 17 cents postage and insurance. You'll find it a splendid presentation piece; one that will be welcomed and cherished. For N.Y. City purchases add 3% sales tax. Address, **THE ELKS MAGAZINE, 50 E. 42nd St., N. Y. 17, N.Y.**



delinquent areas, where they are compelled to associate with criminals, to see a better way of life, and to save them from joining these delinquent gangs.

One of the best ways is to help these "border-line" boys to join some constructive group, such as the YMCA, the Boys' Clubs, and, of course, a Boy Scout troop.

Because of their well-known interest in doing something for "less-chance" boys, Elk lodges in many parts of the country are doing an outstanding job in this phase of scouting. I am convinced that many more would if they knew of the need and could be shown the way.

From time to time I am asked the question, "But doesn't it take a lot of money to sponsor a troop?" When you see how much the successful troop does for its members, you would naturally expect it to cost a lot of money. On the contrary, the actual cash outlay is very small. In most cases, \$25 to \$50 per year is all that a sponsor needs to budget for a well-run troop. One of the principal things that Scouting teaches boys is self-reliance, and all scouts are urged to earn money for themselves to buy their uniforms and pay a small weekly fee into the Troop treasury for incidental expenses.

**S**OME sponsors help scouts obtain uniforms and equipment by advancing necessary funds with an agreement that the boys will earn money to repay the advance. It costs so little to belong to the Scouts that no boy need be deprived of the benefits of Scouting because of money.

The most important contribution of the lodge is the time of the members who volunteer to supervise and run the troop.

"But," it will be asked, "how does the scout program help the boy?"

About 50 years ago during the Boer War, a general in the British Army, Robert Baden-Powell, who was besieged by the enemy in a small town in South Africa was so hard pressed for personnel that he had to draft the small boys in the besieged town to take on some of the heavy and dangerous responsibilities of the defense of the town.

The result was a great surprise to the General. He was amazed at the response. These lads not only served faithfully and efficiently but were constantly asking to be shown new skills that might make them more helpful. When the war was over, Baden-Powell wrote an article in a London paper about his experiences, telling of the fine things the boys had done. The reaction to this article was phenomenal. Not only did he receive requests from heads of all kinds of organizations who were looking for a program for their boys, but he received thousands of letters from boys asking him to show them how they could learn the skills that he had taught the boys in the besieged city.

To answer all the letters, he started writing a series of articles called, "Scouting for Boys." Out of this grew the great

International movement of Scouting that now is in operation in 60 different countries. In the United States, over 25,000,000 men have had this Scout training. Its phenomenal success is due to the fact that the program is full of opportunities for boys to do the kind of things they naturally want to do—camping, swimming, hiking, playing and having fun together. While they are participating in these activities, they are being taught a code of ethics that they easily understand, willingly accept, and enthusiastically practice. In after years most of them acknowledge that this code was one of the important influences in their lives.

The code of ethics:  
*"On my honor  
 I will do my best  
 To do my duty  
 To God and my country  
 And to obey the Scout Law.  
 To help other people at all times  
 To . . . ."*

Nearly everyone in America knows the Scout oath. How wonderful it would be if nearly everyone tried to live up to it!

The Scout Law:  
 "A Scout is trustworthy.  
 A Scout is loyal."

There are twelve of these laws. The last one,

"A Scout is reverent."

Today, wherever you go, where men are associated together in organizations of responsibility and leadership you will find that the majority of them were trained in Scouting.

Seventy per cent of the members of the Junior Chamber of Commerce were former scouts. Sixty-three per cent of the midshipmen at the Naval Academy; sixty-eight per cent of the cadets at West Point.

During the second World War the mere fact that a boy had attained the rank of Eagle Scout assured him of a position of leadership and responsibility in any branch of the Armed Services, and in many cases led to a commission as an Officer.

The young officer mentioned in the beginning of this article stated that the training he got in Scouting and the attainment of the Eagle rank was the major factor in helping him to win his Commission in the Navy.

We live in a precarious time. If it is uncertain and disturbing for us adults how much more unknowable and doubtful must it seem to young men and older boys. A long life of experience with young people has taught me that next to his home and church there is no greater steadying influence in the life of a boy than that of a man who will act as a wise counselor and friend.

Many people talk of the problems and faults of youth, too few do anything about it. Many do not know what to do, some have found a way. There are many ways; it is no idle boast to state that one of the best ways will be found in the program of Scouting.



# Rod and Gun

(Continued from page 10)

"Why ah'm still pastoring the church down the road. You know," he went on, meditating, "ah know all the best hunting and fishing country in Florida. Ah pastored a church way up north, near the St. Johns. Ah pastored a church in the lakes country. Ah pastored a church down here. Why ah've pastored a church everywhere there's birds or bass!"

"Where would you say there's good bass fishing near here?" I asked.

"Bass fishing? Ah'll tell you. Go out the canal from Moorehaven to Okeechobee," he instructed. "You'll pass an island and come to a big bay with a creek coming into it. That's what they call Fisheating Creek. It's a clearwater creek. Why you can see those bass come for twelve feet to hit your plug! That's the place!"

I've always had a feeling the pastor knew what he was talking about, but there is no end of excellent bass water in the state, such as the Kissimmee River, which also flows into Lake Okeechobee, of Lake Kissimmee, or Lake Apopka, or the Myakka River, or the Withlacoochee River, and many, many others. No matter where a person might choose to stay in Florida, he can find bass fishing not too far away.

**T**HE DRAINAGE canals along the Everglades, mentioned earlier, provide some very unusual and spectacular fishing. Land reclamation in general is the worst thing that can happen to game and fish. Drainage projects of any kind normally spell disaster, but these canals are the exception that prove the rule. The vast Everglades—about eight hundred square miles of swampland at the southern end of the state—are teeming with a swarming mass of living things: fish, birds and reptiles. The shallow, warm water and the constant sunshine make the ideal combination to create and sustain primitive life. But the Everglades, as anyone who has traversed them knows, are hardly the place for a tourist fisherman.

Black bass will be found only in the sweet-water ends of these canals. Wherever the water is brackish—which might be a good many miles from the sea—there may be tarpon, snook, redfish, mullet and other inherently salt-water species, but no bass. But where there are bass and bream, there are lots of them. They are not as large as those found in the deeper lakes and rivers—a five-pounder is a big one—but they are plentiful.

Of course there has to be some sand in the sugar. Canal fishing is, conveniently, a foot proposition, and the sand in this case is the cottonmouth water moccasin—although, even if he is classed as a deadly poisonous snake, he is more of a mental hazard than an actual one. I have seen hundreds of them deep in

the 'glades and a rare one or two near a roadside canal. As a result I have no fear of them. I respect the lethal power of a diamondback, but find a moccasin only repulsive, and this because of his appearance. The only real danger from a cottonmouth is that he is so slovenly that a fisherman could possibly step on one inadvertently and be struck. If anyone is going to be this careless, he should at least step on the snake near its head. As one old cracker put it, "Ah just grinds their heads into the dirt with mah bare heel."

A far more real hazard to Florida bass fishing is an innocuous-looking object called a water hyacinth. This is a small, floating water plant with a light-blue, spiked flower which, I suppose, could be considered pretty by people who like light-blue, spiked flowers. The story of the hyacinth as I understand it is that a man living on a lake near the St. Johns River imported a few of the plants from their native India about 1890. He thought they would beautify his lake. In no time they not only beautified it, they filled it full from bank to bank, like a carpet. Some of them either overflowed into the St. Johns or the gentleman in question dumped them there in a futile attempt to be rid of them. In any case, within ten years the Department of Agriculture began to seek a means of controlling the prolific plants because the great masses of them were interfering with navigation and recreation along the St. Johns. The Federal government, the state of Florida and private landowners are still trying to keep them in check, without success.

Nine times out of ten when the natural flora or fauna is interfered with by the introduction of a foreign species, it is eventually regretted. Witness, for instance, the starling, the English sparrow and the German carp—and the hyacinth.

The rafts of hyacinths covering hundreds of acres of water have made large areas unfishable. Since they are free-floating, they shift with the wind on large bodies of water. A man might start out one morning and find that he can't get within a quarter-mile of his favorite fishing hole. Yet, as big a nuisance as the hyacinth is, there is still plenty of available bass water and bass in Florida.

My favorite way of fishing for Florida bigmouths—or any bass, for that matter—is with a surface lure. I like to tease them with a top-water plug, and I enjoy seeing the strike as much as any part of bass fishing. There are days, of course, when they won't come on top, and there are places where the weed growth makes such a lure impractical. When this is the case, the surest type lure in my experience is of the weedless-spoon and pork-chunk combination. Or, if not that, a pork chunk alone on merely a weedless

## Get this double-value TRAIN BOOK OFFER!

192-page, illustrated book on *How to Build and Operate a Model Railroad*.



New 44-page catalog of American Flyer trains and accessories in full color.



A world of railroad fact. Loads of action photos.

See the complete, famous-for-realism American Flyer line. Only scale model trains that run on 2-rail track, have puffing smoke, choo-choo, Pull-Mor power.

### BOTH ONLY 25¢—SEND TODAY

(or the catalog shown, 10¢)

Gilbert Hall of Science, Dept. 43  
Erector Square, New Haven 6, Conn.

I enclose 25¢. Rush both big train books.  
 I enclose 10¢. Send catalog only.

Name.....

Street.....

City..... Zone..... State.....

Offer good only in U.S.A.



### Everlasting Bronze BOOK OF MEMORY

For listing 100 to 3000 names economically. Write for free folders including photos of hand-chased cast bronze plaques.

NEWMAN BROTHERS, Inc.  
Dept. 722, Cincinnati 3, Ohio

### STAMP COLLECTORS 308 DIFFERENT STAMPS 25¢



Including scarce Trieste collection. United Nations Issue. Olympics. Latest Wild Animal Set—in gorgeous multi-color showing the Lynx, Bear, Chamols, Deer, etc., Stamps from riot-torn Trieste are becoming very scarce. These are only part of the big collection of 308 all different foreign stamps Cataloging \$7.00 that you get for only 25¢ to introduce our approval. IDEAL STAMP CO., Dept. 3B, P.O. Box 64 West Farms Station New York 60, N. Y.

not everyone does as well, but E. O. Lockin, who started a business of his own, reports...

for 12 months I've averaged **\$800 PER MONTH INCOME**—most of it clear profit for me!

Many men have discovered how to be independent, to be free of bosses and layoffs. L. A. Eagles grossed more than \$200 his first week. Others report gross up to \$12,000 per year. How much you make depends largely on you. You need no special skill, no large investment.

**No shop necessary.** Our ELECTRIC RUG WASHER cleans rugs, carpets right on floor... helps to show their natural color and beauty. So efficient and safe, used by largest hotels and railroads.

You take no risk. Machines fully guaranteed. Write for full information including how to make big profits in YOUR OWN BUSINESS.

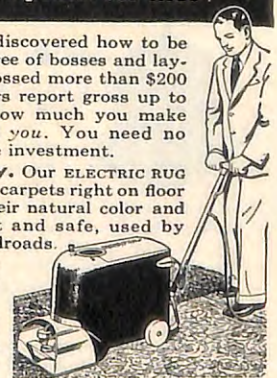

#### MAIL COUPON TODAY FOR FREE BOOK

VON SCHRADER MFG. CO., W24"R" PL., RACINE, WIS.  
Without obligation, send your FREE booklet containing information about your ELECTRIC RUG WASHER and how I can start my own permanent, profitable business.

Name.....

Address.....

City..... Zone..... State.....

## DOUBLE-BREASTED SUITS "SINGLE-IZED" © 1954



### SEND NO MONEY!

We will completely RE-STYLE and RE-DESIGN your OUT-DATED DOUBLE BREASTED SUIT or TUXEDO into a SMART NEW SINGLE BREASTED MODEL with all the Newest Features of Present Day Styling for only \$25.

Here is all you have to do! SEND NO MONEY—JUST SEND US YOUR COAT! Tell us how LARGE or how SMALL it is across the WAISTLINE, or if it FITS AS IS. We will Completely RE-DESIGN it into a NEW SINGLE BREASTED MODEL, and return it POSTPAID in 2 WEEKS! ALL YOU PAY IS \$12.50 ON DELIVERY!

We are So Sure you will be Completely Satisfied, that we will bill you for the \$12.50 Balance, ONE WEEK AFTER you have received and inspected your finished garment! We have "SINGLE-IZED" over 15,000 DOUBLE BREASTED SUITS & TUXEDOS TO DATE FROM ALL OVER THE WORLD!

RESULTS "POSITIVELY" GUARANTEED...WRITE DEPT. 3 FOR FREE BROCHURE

**Sid Colburn** 313 NORTH BEVERLY DRIVE  
BEVERLY HILLS, CALIFORNIA  
(REFERENCES: BEVERLY HILLS CHAMBER OF COMMERCE)

## WANTED MEN AND WOMEN

GROW MUSHROOMS. Cellar, shed and outdoors. Spare or full time year round. We pay \$3.50 lb. WE PAID O. Babbitt \$4,165.00 in few weeks. Write for FREE BOOK, Washington Mushroom Ind., Inc. Dept. 226. 2954 Admiral Way, Seattle, Wash.



## DEER HUNTERS

Your Deer Hides Tanned  
AND CUSTOM MADE INTO  
Beautiful Dress Gloves  
MOCCASINS • HANDBAGS • COATS • VESTS  
Deal Direct—Catalog on Request  
J. R. STYRES • Little Falls 11, N. Y.

## 20 LARGE NEW TOWELS 5¢ EA

Incredible, but true! 20 large-size, new towels in colors and white — for only 5¢ each! Minimum order 20 for \$1.00. (Pls. include 15¢ extra for postage and handling, or \$1.15 in all for 20 Towels). Others charge \$1.00 for only FIVE unwoven cotton and rayon towels like these but we made a terrific purchase and are passing savings on to you. Limit — 2 orders per customer. Money-back guarantee. Order TODAY! Make wonderful gifts.  
NICKEL TOWELS, Dept. 615, Box 881, St. Louis, Mo.



## FOR Your Favorite Elk

Here is an official Elks pin, approved by the Grand Lodge, specially designed for that member who has been an Elk for 30 years. As are other pins designating membership or years in the Order this pin enameled red, white and blue as shown is a truly handsome example of craftsmanship. Any Elk entitled by years of membership to wear it will be proud to display it. It is a life-long gift that will bring years of fond memory of the one who gives it. Three varieties—one #10 plain with no jewel—\$8.25. #10A Same design but set with one blue sapphire—\$9.90—Third pin #10B set with sparkling diamond \$19.00. All three 10kt gold with gold plated post and attaching button. Please order by number. Prices include Federal tax. For N. Y. City orders add 3% sales tax. Sent post paid including insurance. Allow two weeks for delivery. Order your gift pin TODAY from THE ELKS MAGAZINE, 50 E. 42nd St., N. Y. City 17, N. Y.

hook, or any of the several varieties of weedless pork-rind hooks, or imitation pork-rind wigglers.

A bass-fishing friend of mine says he has discovered the final answer to this bass fishing business. He uses a pork chunk on a weighted, weedless hook, but the secret is in the method. He allows it to sink after his cast until it comes to rest; then he retrieves it slowly, dragging the chunk along the very bottom. They eat it up, he says. I intend to find out about it the next time out.

Any bass fisherman going to Florida should take time out to visit one of the well-advertised giant springs where through an underwater porthole he can observe bass going about their daily affairs virtually as though he were in the same medium with them. Maybe he will find out something about fishing. A fellow can often learn quite a bit just sitting back and watching. In any case, he will find it interesting to break the barrier of elements between himself and the fish and to watch how a bass makes his living.

One thing I learned at such a spring is that a bass's aim improves with age. A swarm of small bream had been attracted by some bread crumbs, and a pound-and-a-half bass tried desperately time after time to catch one of them. He missed so pitifully so often that he finally became discouraged and swam away as though sulking. Obviously, from that exhibition, it isn't always the fisherman's

fault when he misses a strike. On the other hand, I kept my eye on a big eight- or ten-pounder wandering lazily in and out among scores of bream as though uninterested. Suddenly he shot ahead and engulfed one so deftly that it was difficult to follow the movement. He didn't miss. Why he passed up hundreds of others and chose that particular one I don't know, but I would like to know. Continued observation might give a hint to his important decision.

A peculiar thing is that the bream and other small fish do not appear to be particularly concerned about the bass. They apparently accept the hazard of their presence as part of a bream's life. Yet, when a big old alligator snapping turtle came lumbering along, every living thing gave him a wide berth. They all realize and respect the power of his jaws and the extent of his appetite.

An hour of watching fat-bellied old bass at such a spring will do one thing for a fisherman: it will make him want to get a rod in his hand and start for the nearest lake. He will know at a glance that there is some fine fishing to be had in Florida other than in the deep-blue sea. This fresh-water customer may not be as big or spectacular as his Gulf Stream cousins, but an eight-pound bass is quite a trophy at that. And, not to be disregarded, he is not a charter-boat proposition. He was put there for us rowboat fishermen.

## Fresco Thompson

(Continued from page 7)

Amoros who made that amazing catch to start the ruinous (for the Yankees) double-play in the seventh game is also a Thompson production. The tiny Cuban wanted \$1,000 to sign off a rough island equivalent of one of our own sandlots.

"Give it to him," ordered Fresco in a decisive telephone conversation with Brooklyn's on-the-spot Caribbean scout, Al Campanis.

Fresco Thompson, originally out of Centreville, Alabama, by the way of Chicago, St. Louis, and the Washington Heights section of New York City, is now a solid burgher of Freeport, Long Island. At 53 he has held on to his sense of humor. He's even an excellent listener.

Thompson has managed to laugh in situations, too, where other men would have let grandma have it right in the shins. He has also managed to survive several changes of top management in the Dodger set-up, which makes him a kind of a Dr. Karl Menninger able to quote the baseball rules book backward.

Humorous? Yes. Clown? No. Clowns don't wind up as chief architects of world championship baseball teams.

A Fresco-and-the-Dodgers history is pretty much a chronicle of the rise of Brooklyn from the status of a pre-war sports-page joke to the strongest team in baseball today. Fresco has been a part of

the whole Wagnerian epic in Brooklyn.

He played second base for the Dodgers in 1931 under the famed Uncle Wilbert Robinson. The Robins (out of honor to Uncle Robbie) suffered from a painful attack of the shorts in two vital categories—finances and players. Also, sometimes they'd change presidents of the club without advising the manager.

Fresco managed in the Brooklyn organization under the brilliant but unpredictable head man, Larry MacPhail. He was the manager of the Reading, Pennsylvania, club which MacPhail bought from a disgusted absentee Maryland chicken farmer for \$5,000. Included in the purchase price were 40 uniforms, 20 players and a 20-passenger bus still doing service today somewhere in the Dodger organization. So is one of the 40 players. You might have seen him on TV last October—Carl Furillo.

MacPhail went off to war and Branch Rickey took over as the No. 1 man in Brooklyn. Thompson managed in the upper echelons of the minors for the Mahatma. When Walter O'Malley, current panjandrum of the Brooklyn shooting preserve, bought out Rickey for a million dollars after the 1950 season Fresco stayed, although he was commonly regarded as a Rickey man. Moreover, in each succeeding switchover of power

Thompson has always moved up a notch or two.

The last boost moved him to vice-president in charge of farm operations and scouting. That is a job in baseball second only to the one occupied by the man who has to go ask the bank for additional cash.

Depending on the viewpoint, there could have been an even bigger boost for Fresco Thompson just a few months after his 50th birthday. When the time for Charley Dressen to leave after the '53 World Series, O'Malley's choice for field boss was Thompson. Thompson's choice was to continue as talent boss. So, O'Malley turned to the candidates within the organization, and that's why the picture of Walter Alston is adorning magazine covers this winter rather than Fresco Thompson's.

Why did Thompson turn down the job of piloting the most colorful club in baseball at what would probably have been a juicy boost to an already ample salary? It goes back to a decision made in the late years of World War II while leading a bunch of re-treads and 4Fs through the motions as the New Orleans entry in the Southern Association.

**A**T THE end of 1945, Thompson surveyed what had been seven or eight entertaining years of managing in the minors, from way down in Williamsport, Pennsylvania, up through Montreal. Fun? Yes, but fun's only fun. It was time to think of the future.

"I sat down and wrote Branch Rickey a letter," recalled Fresco, "and when I look back it was a pretty important one. I wrote him that I wanted to get somewhere in baseball where my own efforts produced the results, not where everything depended on a man who I had no control over, hitting the ball or making the right throw."

It was the big decision in Fresco Thompson's life. The sharpest brain in the business, whether it belongs to Casey Stengel, Alston, Mayo Smith, Marty Marion or Mike Higgins, to name some of 1955's more successful pilots, must go for naught if the hand of the man clutching the bat in that vital situation trembles at the crucial moment.

The minors, thought Fresco, had been fun, but now he was big-city minded. When there was a sudden desperate need for personnel in a place like Thomasville or Newport News, Fresco thought it would be nice if he was on the listening end instead of the beseeching one for a change, too.

Rickey also thought it a good idea. Thompson moved pronto into the more than slightly-frenzied atmosphere on the fourth floor of 215 Montague Street in downtown Brooklyn and has been there since.

Yes, the minors had been fun and there had been plenty of situations like those which had been used to point up the wise-cracking abilities of Fresco's in that pre-



*If it weren't for brand names*  
**You'd have to be a doctor  
to buy the right baby food**

You're fussier about a baby than anyone else in the family.

You shield him from drafts, boil his dishes, measure his meals by ounces.

Yet you don't hesitate to let strangers fix his food! You buy it in cans or jars at your grocer's. And you know you're right.

How can you be so sure? In fact—how can you be sure about anything you buy? Isn't it because you've learned the basic rule of safe and sound buying:

**A good brand  
is your best guarantee**

No matter what kind of a product you want to buy, you know you can trust a good brand. You know the company stands back of it because its reputation is at stake. And so—you know you are right.

The more good brands you know, the better you buy. Get to know them in this magazine. You'll cut buying mistakes—get more for your shopping dollar.

BRAND NAMES FOUNDATION  
Incorporated  
A Non-Profit Educational Foundation  
437 Fifth Ave., New York 16, N. Y.

**A GOOD BRAND IS YOUR BEST GUARANTEE**

viously-mentioned article. There was the time when a leading doctor-fan had been "riding" Fresco all season. Fresco maneuvered the tables on the medico in drastic fashion.

"I had a good boy pitching a two-hitter," smiled Fresco. "He had a two-run lead, but he gave up a single and a walk. I went out there to take him out. As I came out of the dugout this doctor, in a front row box, called, 'Another mistake, Thompson?'"

"I stopped right there. 'A mistake, doctor? Well, at least MY mistake will be able to work tomorrow.'"

Fresco thought back over the years. "You know that guy tried to get my job just for that crack. Claimed I was picking on him."

Then there was that triple play in Montreal. An eminent stockholder in the club was on hand and witnessed his first triple killing. The stockholder was a big man in the dry-goods business; in baseball he didn't know the difference between a fungo and a foul tip.

That didn't stop him. Next morning he was in the Royals' office bright and early. "Fresco," he offered sagaciously . . . "thees play I see las' night. . . . The one that gets trois hommes . . . beg par'on, t'ree men. A verr' good play. Yes! We can have lots more of them, oui?"

Enough of the past lest Fresco hurl that "clown" charge again. Clowns aren't charged with the dispersal of roughly eighteen per cent of every revenue dollar taken in by a major league ball club (double that if player bonus payments are included.) Clowns don't make decisions where not only the current financial health but the future personnel welfare of a major-league ball club is concerned.

Somewhere along the World Series trail in September you thrilled to the double-barreled victory performances of youthful Johnny Podres. There was a long chain of events which led to the pale-eyed lefthander's getting the Yankee one-two-three in the ninth inning of the seventh and final game of the World Series.

The chain had to start somewhere. It started with the decision to give the young man a thousand-dollar bonus to sign, and to throw in a small cash consideration for his father, who had been a high school pitcher before him for the same iron-mining community up in Northern New York.

Who made the decision? Put a couple of check marks alongside the name of Lafayette Fresco Thompson.

The name is legit, all the way, although the "Lafayette" has virtually disappeared. Once when Fresco was sold by Pittsburgh to Buffalo some acerbic Pittsburgh scribe scribbled, "Lafayette Fresco Thompson and all his names were released outright to Buffalo today."

The name has figured on the sports pages in one way or another for more than a quarter of a century. It started

when he was named to the all-scholastic New York City team while playing for George Washington High School. It rings a bell in such places as Grand Island, Nebraska, Kansas City, Omaha, and such National League cities as New York, Brooklyn, Pittsburgh and Philadelphia. It's a name most people couple with a sharp and ready wit. In retrospect a lot of people now pushing fifty or having traveled beyond that milepost are apt to say, "he had to be slick-talking; he wasn't much with that bat."

A base and base-less canard! Thompson, judged by today's standard, was an ample hitter. With the Phillies in four years his lowest mark was .282. How many teams today would turn down a .282-hitting second baseman who also knows what to do with a glove? Even in Fresco's last full year in the majors under Uncle Robbie in Brooklyn he hit .265.

**F**RESCO'S trouble was that he played with what was probably the heaviest-hitting second-division club in major-league history in Philadelphia.

"I hit .324 one year and I wound up as the sixth or seventh-place hitter on the club," he recalled. "They wouldn't even let me take batting practice. I wasn't allowed to speak to guys like Lefty O'Doul and Chuck Klein."

In Philadelphia, Fresco was named team captain, got an extra \$500 for additional duties like carrying the line-up card out to the umpires. In later years he described his captain duties as something akin to being foreman of a WPA leaf-raking detail. And if this compari-

son means anything to you, you're starting to get up there in the years, too.

Fresco helped slice no World Series melons with the Phillies but he had fun. There were things like four-game series with the Pirates in which *both teams* scored in double figures in *every game!* There was also an opportunity to coach at third.

Fresco loved to coach, especially when they were playing Cincinnati and a large lefthander named Eppa Rixey was pitching. Rixey compiled a tremendous record for the Reds; he won more games than any other lefthander in National League history and some day he will grace the Hall of Fame. For Thompson, however, he was a sitting duck.

Rixey's trouble was that he was still fighting the Battle of Shiloh, almost three-quarters of a century after the final results were in. College man, too.

So one college man, Thompson (Columbia) went to work on another (U. of Virginia) and it was an awesome job Fresco did. Just by whistling. He whistled one tune over and over as Rixey sought to catch the corners of the plate. It wasn't even a new tune, just an old war ditty, "Marching Through Georgia." It drove Rixey into a positive frenzy and it didn't cool him any, either, to learn that the fellow doing the whistling was a native Alabaman.

It was through his Alabama connections that Fresco got his first job managing, just as he had used a rather close connection—his father—to get a job playing with Grand Island in the Nebraska State League.

Actually, Fresco had first obtained a

---

## Visiting the Lodges with John L. Walker

(Continued from page 39)

was on the 12th, when Mr. Walker spoke to a dinner gathering at **WILLISTON LODGE**. Exalted Ruler Herman Schmitz presided and among those who heard Mr. Walker speak was Congressman Usher L. Burdick, a member of Williston Lodge. Mr. Walker made a tape recording for Radio station KGCX and his speech was broadcast over station KEYZ.

At **MINOT LODGE** the next day Exalted Ruler L. Donald Thorson and other officers, along with a large turnout of members, greeted the Grand Exalted Ruler at a luncheon in the lodge's year-old half million dollar home, which Mr. Walker described as one of the finest new lodges he had seen. Later that day the Grand Exalted Ruler visited **DEVILS LAKE** and **GRAND FORKS LODGES**. As he departed the Grand Exalted Ruler commented on the vitality of Elks lodges in North Dakota and their many accomplishments.

On October 16th the Grand Exalted Ruler was guest of honor at a luncheon given at **WATERTOWN, S.D., LODGE**. Among the luncheon guests were Past Grand

Exalted Ruler James G. McFarland, Glen S. Paterson, member of the Grand Forum and District Deputy Harold Ricketts, and Jack Hoffman. Esteemed Loyal Knight of Watertown Lodge. The latter two accompanied Mr. Walker on his tour of South Dakota.

That evening the Grand Exalted Ruler was honored at a dinner given by **HURON LODGE**. Exalted Ruler John Skvaril was host at the affair, which was held in the Elks ballroom at the Hotel Marvin Hughitt and was attended by several hundred members. Among the guests, in addition to the members of the official party, were Past District Deputy Fred D. Leach and State President Kenneth L. Roberts. The feature of the menu was a State Fair prize winning 4-H Club baby beef. The highlight of the event was a stirring speech by Mr. Walker.

The following day the Grand Exalted Ruler was entertained at a noon luncheon at **MITCHELL LODGE**. Exalted Ruler R. E. Morgan was present, as well as all the members of the official party.

job as an infielder with Cedar Rapids in the Mississippi Valley League. Got it, \$150 a month and all, all by himself, just by writing and enclosing some of his all-scholastic clippings.

Fresco's father, a shoe buyer for J. C. Penney, however, had been at a convention at Atlantic City, had gotten to chatting about his son who, he boasted, was a professional baseball player. One of his listeners was the manager of the J. C. Penney store in Grand Island. He perked up his ears. He was also the president of the Grand Island ball club. "I'll take him," he said, with one eye on the talent aspect of the deal, the other on how it might help his business career.

How did the young man work his release from Cedar Rapids? Merely by writing and asking for funds to get there. His unconditional release came in the return mail.

The family angle bobbed up again in Fresco's first managerial job. In Birmingham he had an uncle who was a judge. The then-owner of the ball club was a lawyer. The judge's recommendations carried a lot of weight.

After Birmingham it was way stations like Hartford, Williamsport, into Brooklyn to help in the front office preparations for the 1941 World Series, then out to Reading where young Lee MacPhail, now farm director for the Yankees, had been installed as general manager by his father ("go down there as manager, Fresco, and help the boy out.")

**M**ORE bouncing around on busses and always the conviction that his destiny didn't lie in the spiked-shoe department but in the front office. "I'd go to the winter meetings each year," observed Fresco, "and I'd see maybe fifty or sixty fellows who had managed the season before now standing around in the lobby looking for jobs. There'd be only one or two front-office fellows in the same spot. And they didn't have that desperate look, either."

Now the onset of World War II started taking its toll of baseball talent. In 1942, one week before the Dodgers' minor league training camp at Staunton, Virginia, broke up, Al Treadway, the manager of the Johnston, Pennsylvania, club in the Class C Middle Atlantic League, was drafted. MacPhail promptly drafted Fresco for the role. He spent the first couple of months worrying more about gas coupons and flat tires than about the club's won-and-lost record.

On Decoration Day that year Fresco wired MacPhail thusly: "Not having heard from you I'm going to pick a new manager from a hat and am coming home." That had results. A couple of days later MacPhail sent a relief and Fresco came back to Brooklyn.

Over the years Fresco has been on the receiving end of some pretty poignant wires himself. The Wisconsin State League is now extinct but the Dodgers once ran Sheboygan there when their

farm system numbered as high as thirty under Branch Rickey.

The manager there was en route to his first pennant and was beginning to get a little nervous about it. He wired Thompson for a hard-hitting outfielder and a good righthanded pitcher. The records in the Brooklyn office showed the club was in first place by 11 games, had only 9 to play.

Fresco's return wire read: "Outfielder? Pitcher? What for? You can go fishing for the rest of the year and still win the pennant." He also treasures the memory of another plea for help which read, "temporarily in first place by five games but need help badly."

Life in Montague Street, together with flying trips to such outposts as Montreal, Mobile, St. Paul and Newport News to check on the progress of the local procurators, isn't one long laugh for Thompson. A comedian and nothing more would have laughed himself out of the job many years ago. Last September when the Dodgers were making merry in celebration of their pennant clinching in Milwaukee Fresco was just about as far away as a Dodger official could be. He was at Mobile on a trouble-shooting deal. Was he successful? Well, Mobile managed to finish fourth in the regular Southern Association season, came on to win the playoffs and then came through as the Dixie Series champion.

Running a baseball farm system, even after it's been cut from almost thirty to fourteen clubs, can be compared to something like handling the control tower at Chicago's Midway Airport with one hand. The other is playing a xylophone solo, of course. It ain't easy.

In Brooklyn it's especially difficult because there are two main objectives in the Dodgers' operation. If that reads like faulty grammatical construction, put the blame on Walter O'Malley's desk, not here. He's the head man.

One main objective is to develop players who will win pennants and world series championships for the Dodgers. That's fine and highly commendable, of course. The other main objective is to develop players of such excellence as to convince other clubs to part with large sums of money for them in the hope that they will help win pennants and World Series in their new surroundings.

Between these two goals Fresco Thompson does a daily tightrope stint. Isn't it easier because there are only half the number of clubs, half the number of players, there were to worry about four or five years ago? No, if anything it's tougher. Production on the top level has to be just as high.

Brooklyn, under O'Malley, has made no secret of the fact that its farm system must produce a surplus of players for sale to support the continued operation of the farm system to produce more players for further sales, etc., and here we go around again, boys. The gimmick is, of course, for the Dodgers to skim the

## Become an ACCOUNTANT-Expert Bookkeeper—C. P. A.

The demand for skilled accountants—men who really know their business—is increasing. National and state legislation is requiring of business much more in the way of Auditing, Cost Accounting, Business Law, Organization, Management, Finance. Men who prove their qualifications in this important field are promoted to responsible executive positions.

### FREE SAMPLE LESSON

Knowledge of bookkeeping unnecessary. We train you from ground up, or according to your individual needs. Low cost; easy terms.

Send name and address on the lines below for free Sample Lesson and 48-page book describing the LaSalle accountancy training and the opportunities in this highly profitable field.

**LASALLE EXTENSION UNIVERSITY**  
*A Correspondence Institution*  
417 S. Dearborn St., Dept. 12328H, Chicago 5, Ill.

Name.....  
Address.....  
City.....Zone.....State.....

## REAL ESTATE BE A BROKER

**PAYS BIG! SEND FOR FREE, BIG, ILLUSTRATED CATALOG NOW!** Graduates report making substantial incomes. Start and run your own business quickly. Men, women of all ages, learn easily. Course covers Sales, Property Management, Appraising, Loans, Mortgages, and related subjects. **STUDY AT HOME** or in classrooms in leading cities. Diploma awarded. Write TODAY for free book! No obligation. Approved for World War II and Korean Veterans  
**WEAVER SCHOOL OF REAL ESTATE** (Est. 1936)  
2020H Grand Avenue Kansas City, Mo.

**"I Guarantee Complete Satisfaction or Your MONEY BACK"**

Save money. Send for FREE List of Fine Diamonds. Wonderful values. Hundreds of Beautiful Gems.

**GENUINE DIAMONDS** at **Out of Pawn LOW PRICES**

Exquisite Settings

Unredeemed loan pledges and big buying power enable us to offer Fine Diamonds at Prices far less than original cost. Sent you FREE for INSPECTION AND APPRAISAL.

**PRUDENTIAL LOAN ASSOCIATION**  
**LLOYD J. BUTLER COMPANY**  
133 N. Clark Street Dept. KS Chicago 2, Ill.



**For ELKS—the Gift unusual**

Give your favorite Elk one of these 10kt gold, beautifully enameled red, white and blue Elk insignia pins. It's a life-long gift that he'll proudly wear while always remembering the giver. Post and attaching button gold plated. Please order by number. No. 7 plain pin, no jewel, ppd \$7.35. No. 7S Same as 7 but set with one genuine blue sapphire, \$11.00. 7A Set with genuine diamond, \$20.15. 7B Same as 7A but containing larger diamond, \$28.40. Prices include Federal tax. Order your Christmas gift pin TODAY. Delivery within 2 weeks. For N. Y. City purchase add 3% sales tax. Dept. S, THE ELKS MAGAZINE, 50 E. 42nd St., N. Y. City 17, N. Y.

**60 POWER TELESCOPE \$3.98**  
VARIABLE EYEPIECE 20X-40X-60X—BRASS BOUND

**NEW!** Three telescopes in one. 3 different magnifications. 20 power 3 1/2 in. ut. tra-bright includes with 40 and 60 power for extra long range. Guaranteed to bring distant objects, people, sports events, ships, moon stars, etc. 60 times as close.

Most powerful for anywhere near the money. 3 Sections. Closes to 1 ft. long. Contains 4 ground and polished lenses. Also used as a powerful compound microscope. Directions included. Mass production enables us to offer this instrument at amazing price of \$3.98 complete. **MONEY BACK GUARANTEE.** We pay postage. Get yours now.

**CRITERION CO.**  
Dept. EMB 22

331 Church St.  
Hartford 1, Conn.



*alive today*



*...because  
they went  
to their doctors  
in time*

Many thousands of Americans are being cured of cancer every year. More and more people are going to their doctors *in time*. That is encouraging!

But the tragic fact, our doctors tell us, is that every third cancer death is a needless death...*twice* as many could be saved.

To learn how to head off cancer, call the American Cancer Society office nearest you or simply write to "Cancer" in care of your local Post Office.

American Cancer Society 

cream off the top with the Don Zimmers, the Don Hoaks, the Podreses, the Amorses, the Spooners and the Craigs. And always there have to be the Irv Norens, the Chico Carrasquels, the Billy Hunters, the Sam Jethroes, and the Danny O'Connells available for sale to other clubs at large sums.

Brooklyn, according to O'Malley, is consigned to the have-not category until it gets a new stadium capable of holding those big 60,000 Sunday and holiday crowds. (Ebbets Field holds about 35,000 with the fire department looking the other way). Until that time, and perhaps after that, too, Fresco Thompson will have to keep those "two main objectives" in his sights constantly.

Lesser objectives consist of worrying about 39 scouts, 20 of them full-time employees, and what they're doing at the moment, whether they're in Mexico City or Mexico, Mo., in Caracas or in Carthage, Ill. Scouting isn't just the business of signing talented young men; just as important is the business of *not* signing talented prospects.

"If you sign every good-looking kid who comes along you have to go broke," declared Fresco. "If you miss enough you'll wind up in last place. This is the only business in the world where a young man is paid large sums of money before he proves his ability. You've got to learn to live within a cockeyed economic framework.

"Talent hunting, however, has its compensations. You go to camp in the spring and you see a kid you signed yourself or told some scout to go ahead and sign. He's grown a couple of inches and he can do things after a year or two he couldn't do when you first signed him. He's doing now what you thought he might eventually be able to do.

"It's a big kick. You see a boy who everyone else passed up and now he shows unmistakable signs of coming stardom and you feel pretty good. And then you see a boy who you paid \$10,000 to and he's no better than he was when you signed him. And you know he isn't going to improve, either."

Brooklyn has to depend more on careful scouting than upon a fat checkbook for a fairly obvious reason. This doesn't cast a shadow on the abilities of non-Dodger scouts. Having the power to give

a red-hot young prospect \$75,000-\$100,000 makes a scout's job tougher, not easier. You give away "x" number of \$100,000 checks to kids who turn out to be duds and pretty soon the man upstairs goes and gets someone else to look the kids over. In the final analysis the business of knowing who *not* to sign shares equal billing with the ability of knowing who to sign.

Intangibles further complicate Thompson's job, along with that of every other farm director. Every letter, no matter how impossibly nutty it sounds, is subjected to careful scrutiny and investigation if it refers to talent. Every kid who asks for a "look" gets some kind of a test.

Why? Because while the \$100,000 bonus boys grab the headlines the facts remain, and will continue to remain, that the bulk of the major league players still sign for nothing or almost nothing.

Fresco has his nose planted too deeply into reports, box scores, rules, draft lists, waiver lists, options and airplane and railroad schedules these days to get much of a chance to see many ball games. If he sees a hundred a year it's a lot. The minor-league encounters he witnesses on rutty infields under deficient lighting systems probably outnumber the major-league games three to one. His job is not to watch the major leaguers, however. He has to come up with the kids who will be playing on the major-league diamonds four or five years from now.

Baseball has been good to Fresco Thompson and Fresco has been good for baseball. In choosing it as his life's work, however, he was aware that he'd be at home far less than most people—like people, for instance, engaged in making penicillin, perusing gas meters or penning TV commercials.

It's had its compensations, though—Florida every spring, the President's box at the World Series, and enough money to send his only daughter, Ann, abroad last summer for a vacation.

Ann visited several places in Germany. She liked Heidelberg best, and the ecstatic post card she sent Daddy emphasized that there were 40,000 American GIs stationed there.

"Heidelberg! GIs!," snorted Fresco. "If it's GIs she wanted she could have taken the bus down to Fort Dix."

### **In the Doghouse**

*(Continued from page 36)*

The three-shot treatment is given over a period of about three weeks and is said to confer about 97 per cent immunity. If the kennel says that it has had its dogs inoculated the buyer of the dog should get a kennel certification or a copy of a certification issued by the vet who was said to have given the inoculations. But inoculation or not there is no certainty that the dog will escape distemper—only that 97 per cent margin of safety. If the dog has not been inoculated the owner

should bring that pup to a vet as soon as is possible after having purchased the dog. Fortunately, one attack usually brings life-long immunity.

This disease was noted early in the 18th Century and despite years of research it still remains a medical mystery. At Cornell University, Ithaca, New York, one of the leading centers of research into animal diseases, there is the Dog Disease Laboratory housing the most up-to-date scientific equipment and staffed

by some of the nation's leading researchers. In that laboratory there are constant efforts made to find the causes of some of the most prevalent dog diseases and it is hoped that the virus of distemper may soon be isolated and a cure, or better course of a treatment, developed for dogs so infected. At present there is no known cure.

It is estimated that one out of every four dogs afflicted with this disease dies from it. Where or how the germ is spread is a scientific riddle. It is known that dogs, as previously mentioned, contract it from other animals, or even from the clothing of an owner of an infected dog. One instance I can recall is that of an owner of a kennel of some of the top-flight dogs of the show ring who didn't believe in inoculation of his dogs. There came a day when he visited a competing kennel where several infected dogs had been isolated. Upon returning to his own kennel it wasn't long before his dogs became infected. The carrier was his clothing. He lost more than \$20,000 worth of dogs. The isolation of the sick dogs in the competing kennel did not eradicate the germ. A while back I men-

tioned that one attack usually, but not always, confers immunity. The reason is that the living virus of the disease remains permanently in the system and later exposure, as a rule, fails to create a second attack.

The symptoms appear in about one week, sometimes less. There usually is a high fever, a yellow discharge from the nostrils, inflamed eyes and scabby skin. The dog may frequently cough and be extremely listless. Loss of appetite accompanies an attack. The fever will run for three or four days and may end by the dog seemingly becoming normal. After an interval of about three days, if it is true distemper, the symptoms will return, this time considerably increased. The owner who gives more than casual attention to the pup will always have a thermometer at hand as temperature is one of the reliable indications of a dog's health. The average, healthy pooch will register about 100.5 degrees. If this climbs to 103°, the dog should be carefully watched. If the thermometer reads 105°, pneumonia or distemper are most likely to be present. At 107° the dog is through with this world.

## Guard Against Impostors

For the past few years, The Elks Magazine has viewed with no little alarm the operations of a ring that has been selling fake membership cards to confidence men and other unscrupulous persons.

These individuals pose an immediate threat to our members with whom they come in contact and a more remote threat to our Order itself. Not only do they cheat members out of a substantial total of money annually, which is an important item, but they sow seeds of distrust of all visitors to a Lodge home which could ultimately wipe out the warm spirit of friendliness and hospitality which now exists in our lodges toward all visiting Brothers.

Your Magazine has already done effective work in warnings against these dangerous impostors. In the Confidential Bulletin we mail to every Lodge Secretary monthly, we have focused attention on impostors who hold the fake cards sold by the ring, and have helped Lodges to bar the doors to many of them.

It must be admitted, however, that it is becoming much more difficult to alert our Lodge officers to impostors. The cards they carry today no longer are crude affairs with tell-tale features such as a different type face from that used on our official card. These imitations are now photographic reproductions, facsimiles with virtually no key to their spurious quality.

Your Magazine feels that it is time to direct a warning to Elks individually to be on guard against impostors. Don't let

them take you in with their promotional schemes.

You realize that we can do little more than pass along "a word to the wise." which we trust will really be "sufficient."

Impostors defy classification. They come in all shapes and sizes. They come singly and in groups of two or three. Often, only the principal makes himself known to you, while the confederates lurk nearby to take the money swindled from you and your friends and spirit it away, thus removing the evidence.

Usually these swindlers get off scot free. No one wants to publicize the fact that he was a sucker.

Armed with a warning and some background information, it shouldn't take long to run these swindlers out of Elk fraternal life.

To accomplish the purpose, the warning should reach out to every member of our Order. In your conversations with other members, please refer to this announcement and ask them to be sure to read it with all their attention. It is only by unified action that we shall make it unprofitable for impostors to cross an Elk threshold. In this action, every member has an important part.

It is difficult to manage a two-handled policy of turning in the direction of hospitality and good fellowship for visiting Brothers, and in the contrary direction of swift justice for impostors. But with a little finesse all of us can do both jobs well. We can be pleasant to all visitors, and keep an eye trained for any who step out of line.

## RUPTURE-EASER

(APiper Brace Truss) ®



Double...4.95

Right or left  
Side \$3.95

No  
Fitting  
Required

Pat. No.  
2606551

A strong, form-fitting washable support. Back lacing adjustable. Snaps up in front. Adjustable leg strap. Soft, flat groin pad. No steel or leather bands. Unexcelled for comfort. Also used as after operation support. For men, women and children. Mail orders give measure around the lowest part of the abdomen and state right or left side or double. We Prepay Postage on C.O.D.'s.

811 Wyandotte Dept. EK-125 Kansas City 5, Mo.

### HERNIA (Rupture) CLINIC

Injection Treatment (Non Surgical) 1 week to 10 days in my Clinic or 6 to 8 weekly visits suffice

Also

Hydrocele, Varicocele & Varicose Veins Treated by Injection Method.

Dr. M. A. Brandon Clinic  
215 6th St. Lorain, Ohio

## Don't Neglect Slipping FALSE TEETH

Do false teeth drop, slip or wobble when you talk, eat, laugh or sneeze? Don't be annoyed and embarrassed by such handicaps. FASTEETH, an alkaline (non-acid) powder to sprinkle on your plates, keeps false teeth more firmly set. Gives confident feeling of security and added comfort. No gummy, goeey, pasty taste or feeling. Get FASTEETH today at any drug counter.

## Work, Sleep, Play In Comfort

### Without Nagging Backache

Nagging backache, headache, or muscular aches and pains may come on with over-exertion, emotional upsets or day to day stress and strain. And folks who eat and drink unwisely sometimes suffer mild bladder irritation...with that restless, uncomfortable feeling.

If you are miserable and worn out because of these discomforts, Doan's Pills often help by their pain relieving action, by their soothing effect to ease bladder irritation, and by their mild diuretic action through the kidneys—tending to increase the output of the 15 miles of kidney tubes.

So if nagging backache makes you feel dragged-out, miserable...with restless, sleepless nights...don't wait...try Doan's Pills...get the same happy relief millions have enjoyed for over 60 years. Get Doan's Pills today!



for  
AULD  
LANG  
SYNE

For that worthy member who can point to 25 years of membership in the Elks here is a gift that he's sure to prize highly as a token of the many years he has been an Elk and for the whole-hearted warmth of feeling it expresses. Yes, 25 years is a long time and well warrants recognition and there's scarcely a better way to show this than by giving that Elk one of these handsome, 10 kt gold, splendidly enameled red, white and blue 25 year membership pins. A Christmas gift unusual, 10 kt gold plated post and attaching button. Please order by number, 25 year pin No. 3—\$8.25. Price includes Federal tax. For N. Y. City sales add 3% tax. Delivery within 2 weeks. Order TODAY from THE ELKS MAGAZINE, 50 E. 42nd St., N. Y. City 17, N. Y. Sent ppd., on receipt of check or money order.



Picture frames you can make with hand tools.

BY HARRY WALTON

**F**RAMING YOUR OWN PICTURES gives you a custom job every time. The choice of proportions, molding styles and finishes is all yours, at low cost. Good picture frames can be made with hand tools alone. If you have a circular saw or shaper, you can even make your own moldings.

**BUYING FRAME STOCK.** You may not be able to buy prefinished frame molding locally. It can be purchased by mail from such dealers as Albert Constantin and Sons, 797 East 135th St., New York 54, N. Y. This kind saves you the trouble of finishing, but restricts you

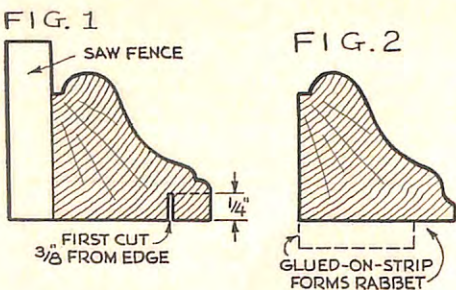

as to choice and costs considerably more.

Some lumber yards carry unfinished frame molding. Oak is popular and lends itself to interesting modern finishes. But if your yard has no frame molding, look over the ordinary builder's moldings at stocks. Common base trim, for instance, has a pleasing shape. What is called drip cap makes excellent modern frames.

**FORMING THE GLASS RABBET.** Ordinary moldings have no rabbet or corner into which to set the picture. If you have a circular saw, it is easy to cut such a rabbet. Set the fence first to cut the inside of the rabbet as in Fig. 1. Then move the fence away from the blade a

little at a time to remove the waste by successive cuts.

If you have no circular saw, pick a molding on which you can build up a rabbet as shown in Fig. 2. Buy an equal length of thin stock such as lattice strip,  $\frac{1}{4}$ " to  $\frac{1}{2}$ " narrower than the back of the molding. Apply glue to this and to one side of the strip. Tack together temporarily with brads, driving these only part way. Wipe excess glue from the inside of the rabbet and the outer edge.

When the glue has set, pull out the brads and, if necessary, plane the strip flush with the outside edge.

A plain smart wooden frame can be made of clear  $1\frac{1}{4}$ " by 2" or 3" stock with a strip glued on for a rabbet and one or both corners rounded with a plane and sandpaper. For deep frames, you can use large cove molding. If the edge is not thick enough to cut the glass rabbet in, or you have no circular saw, plane one edge of lattice strip to 45 degrees as in Fig. 3 and glue it on.

**SIZING UP THE FRAME.** Some pictures look well if they fill the entire frame, but most require a border or mat. The margin around the picture is usually the same width at the top and sides, but slightly wider at the bottom.

Frame members must be mitered—the ends of all four pieces cut at an angle of

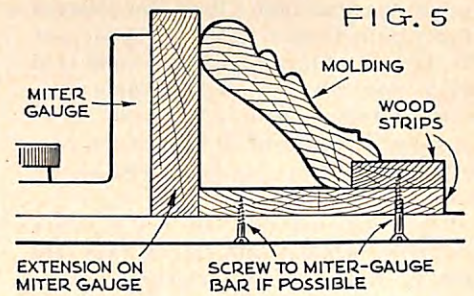
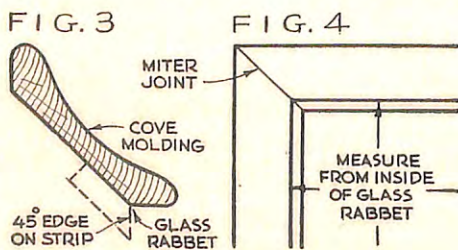

45 degrees. The picture or mat dimension is therefore measured inside the glass rabbet as shown in Fig. 4.

A miter box (which you can buy for less than a dollar) and a backsaw should be used if you cut the molding by hand. It is common practice to lay a piece of wood under the stock to avoid cutting into the bottom of the box.

Cut one end first, being careful to have the sharp point of the miter on the outer edge. Measure from the end of the rabbet and clamp a stop block to the bench top so that, with the cut end against the block, the mark will come under the blade, which must now be in the other groove of the miter box. Return it to the first groove to make the end cut on the second member; then butt this against the stop and use the saw again in the other groove.

This will assure you of identical

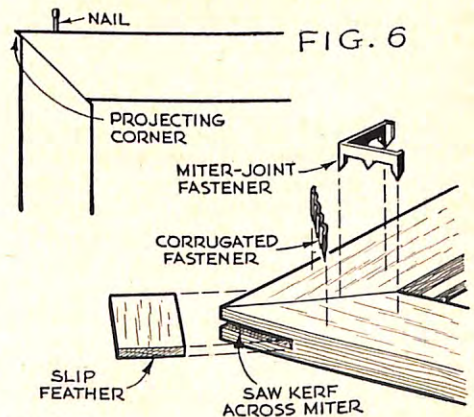

FIG. 7

lengths for two opposite sides of the frame. You will have to reclamp the stop block for cutting the other two sides, unless you are making a square frame.

Use a wooden auxiliary head and a stop block on the miter gauge of the circular saw, swinging the gauge to the opposite 45-degree setting for the second cut on each piece. (Flat stock could be flipped over with the gauge left in one position, but the rounded face of molding makes this inadvisable.)

Deep frames, for which the molding must be sloped rather than flat on its back, are more difficult. If the molding is not too wide, the ends can be cut to the correct angle by holding the stock in the miter box at the angle it will assume in the finished frame. To do this you may



have to insert strips beneath or behind the molding, or both.

It is possible to cut stock for such sloping miter joints with the molding flat on the circular-saw, but both the blade and the miter gauge must be set according to a table of compound-miter angles if this is done.

Instead, you can tack a flat, straight strip of wood, a trifle thicker than the glass rabbet, to a base strip and place the

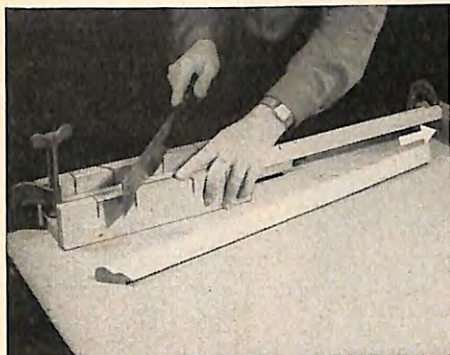

**WOODEN MITERBOX** like this costs little. To cut frame members to exactly identical length, clamp both the box and a stop block (arrow) to the bench. Cut one end of molding; then butt this end against the block to cut the other end as above, using second miterbox slot. It's a good idea to clamp or wedge the molding itself into the box if possible.

molding on both as in Fig. 5. Then carefully cut the molding at the usual 45 degrees.

**JOINING THE CORNERS.** Seal the cut ends with a thin coat of glue, and then apply a second coat for joining. Clamp one piece to a flat surface (use soft pads to avoid marring the molding.) Place the other piece forward of the corner as in Fig. 6. Driving the nail will force it into alignment.

An assembly jig makes the work easier. The photo below shows a homemade one, as well as a method of truing up defective miters.

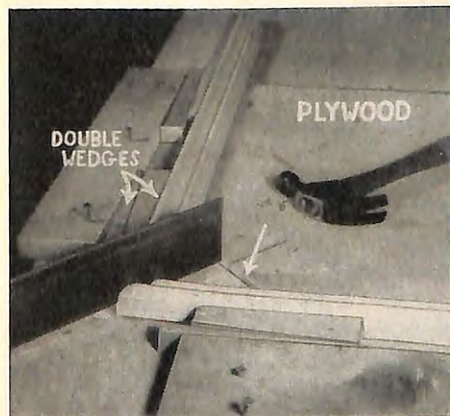

**SIMPLE ASSEMBLY JIG** is made by nailing a square-cut piece of plywood and two lengths of 1" stock to a flat surface. Place glass rabbet of molding on plywood. Clamp molding by driving paired wedges together. A defective miter can be trued by running the backsaw through it as shown. Cut off the corner of the plywood (arrow) to give saw room to cut.

Slip feathers (Fig. 7) join corners without nails. Clamp two pieces at 90 degrees and saw across the corner. Apply glue to the saw kerf and the feather—a thin piece of wood—and drive it in so that the grain runs across the joint. Trim the corners of the feather flush afterward. Figure 7 also shows two other common fasteners, either of which may be used alone.

**PICK YOUR FINISH.** Sand the molding really smooth if you want a good finish. For modern blond tones, use clear lacquer, white shellac or non-darkening varnish. Apply undercoat and enamel for color finishes. White-painted frames can be antiqued by brushing on raw umber or burnt sienna oil paint thinned with turpentine, and then rubbing off most of it.

For a pickled finish on oak, brush on white. Rub off all but what remains in the grain. Then apply a clear sealing coat of lacquer or shellac.

**TEXTURE FINISHES.** Unusual effects can be achieved by brushing on white primer and, while it is still wet, sticking on pieces of lace-cut paper napkins or doilies, or even real lace, as shown in a photo. When this is dry, brush



**TEXTURE TREATMENT** enriches cheap lumberyard molding. Real lace was applied to piece at left, strips of paper doilies to the others. Center molding was gilded all over. The other two were highlighted with gold. For polychrome effect, use several colors. Touch only the high spots, using a brush with very little paint on it. If result is too colorful, you can subdue it by brushing on grayed white and wiping it partly off.

on a second coat. Color highlights may be added as described in the caption for the photograph above.

**MOUNTING THE PICTURE.** The mat and glass should be no more than 1/8" smaller than the rabbet each way. To keep the picture dustfree, you can seal the edges of the glass-picture-backing sandwich with gummed or adhesive tape.

Set it into the frame and drive in brads or glazier's points to retain it. Close up the back by pasting wrapping paper over the entire frame. Sprinkle the paper with water, and on drying it will stretch drum tight. Attach the hanging wire or cord to screw eyes or flat metal hangers nailed or screwed to the frame.

## Furniture Standoffs

### Help to Save Walls



Every time somebody sits down on a chair, couch or sofa placed along a wall it tends to slide back a trifle until some part—usually the top of the back

—touches the wall. This may damage the plaster or the wall finish, besides forming a dust mark that will be prominent when the furniture is next changed around.

Homemade blocks will end this annoyance. With the furniture placed so that no part of it touches the wall, measure the distance from the rear legs to the

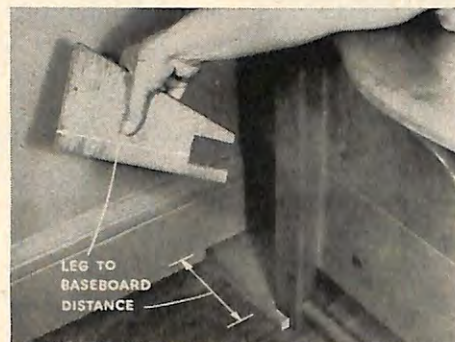

baseboard at the bottom of the wall. Cut two tapering pieces of wood 2" longer than this (a single slanting cut will make both from one piece of plywood or a wide board). Notch the narrow ends to fit the legs, and drop the blocks into place, wide ends against the baseboard. The furniture will never touch the wall again.

## Foil Wrapping

### Keeps Paint Brush Soft



When work on a paint or enamel job must be suspended, you can save yourself the trouble of cleaning the brush by wrapping it in aluminum kitchen foil.

Work out excess paint first. Then wrap the foil tightly around the brush from the ferrule down as shown, using a piece big enough to extend well past the bristles. Fold this end up tightly. Use fresh foil and crease all folds tightly just once; the object is to make an airtight envelope. A properly wrapped brush will stay soft three days or more and can be unwrapped and put to work again to finish the job.—Harry Walton.

# Editorial

## LEE DONALDSON



In September, Lee Donaldson completed twelve months of service as Grand Secretary of the Benevolent and Protective Order of Elks.

That was sufficient time for the members of the Order, very generally, to realize that a most able and worthy successor had been found to fill the place left vacant by the death of the beloved Ed Masters who had served in that office so efficiently for 26 years. This was to be expected, however, because Brother Donaldson came to the Grand Secretaryship remarkably well equipped to meet its responsibilities and administer its affairs.

It is important that the Grand Secretary work in the closest cooperation with the Grand Exalted Ruler. We know that the two Grand Exalted Rulers with whom Brother Donaldson has cooperated will speak only in the highest terms of the intelligent, continuous and loyal support they have had from him.

The Grand Secretary finds that most of his contacts, aside from that with the Grand Exalted Ruler, are with Chairmen of the Grand Lodge Committees, the District Deputies, the Presidents of State Associations and the Exalted Rulers and Secretaries of the 1,746 lodges.

All of these positions Brother Donaldson himself has held and that most creditably.

Strikingly important among his contacts are those with the lodge Secretaries. For this he comes incomparably well equipped as the result of the many years he served his own lodge of Etna, Pennsylvania, in that capacity. Evidence of the success in this vital part of his work is most gratifying.

So long as Lee Donaldson is Grand Secretary we can all know that the office will be diplomatically and effectively administered.

## EDUCATORS AND EDITORS



In 1954, members of the National Education Association and members of the Magazine Publishers Association held, under the auspices of the bicentennial celebration of Columbia University, the first formal meeting to consider their mutual problems, the mutual responsibilities of the schools and the magazines.

A second conference held this year is reported as having carried forward many of the aspirations springing from the first meeting.

The part that each can play was well illustrated by

N.E.A. President, Waurine Walker, when, offering a thanks of the teachers for the "many constructive and informative" articles on education which have appeared in the magazines, she said:

"It is appropriate that we examine and strengthen the very base upon which our freedoms rest, a literate citizenship.

"Our responsibilities might be compared to opposite sides of the same shield. We teachers help our people become literate. You, the writers and publishers help to keep them so."

Walter D. Fuller, Chairman of the Board of Magazine Publishers Association, said:

"Magazine publishers generally regard their periodicals as media for public service rather than purely business. In fact, I do not know of any publisher who has been continuously successful unless he has followed such a philosophy.

"Since we regard the magazine as a great educational institution, we seek close and sympathetic cooperation of the teachers and with organizations for formal education.

"This seems like a natural and a valuable cooperation." We fully agree with Mr. Fuller's concluding statement.

## MOLOTOV'S MISTAKE



The last of the old Bolsheviks holding high place in the Russian government which followed the revolution of 38 years ago in which he was a reasonably important participant has been told to admit that eight months ago he made an "ideological error" that was "theoretically and politically dangerous". He has made the admission and apologized.

This mistake he made was in nearly telling the truth when truth-telling is not a practice in the Communist party.

He said last February that "the foundations of a socialist society have already been built" when he should have said, according to the rulers of the Communist party, the entire structure was completed.

The question now seems to be, shall the man who has been the foreign minister of the Soviet Union for many years be liquidated as was Beria or will he suffer the indignity and humiliation of demotion as did Georgi Malenkov, demoted from Premier to supervisor of electrical industrialization.

Perhaps the answer to this question will be at hand before this reference to the possibility reaches our readers.

Whatever it proves to be may it contribute strength to the fast weakening "Geneva Spirit".

# "Hollywood Bride" WALKING DOLL

UNBREAKABLE PLASTIC

including a Gorgeous  
Trousseau of  
**7 COMPLETE  
OUTFITS**

**BUY DIRECT and SAVE!**  
regular \$14.95  
value **\$5.95**



Coat and Beret



Sheer Nightgown



Plastic Raincoat



Afternoon Dress



Glamorous Hostess Gown



Ballerina Costume

**SHE WALKS!**  
**SHE'S A BIG 19 INCHES TALL**  
**WASH, COMB, CURL HER HAIR**



- SHE HAS ROOTED HAIR
- SHE CAN KNEEL TO PRAY

*Hollywood Bride Has Everything!*

• SITS—STANDS—SLEEPS • HEAD TURNS • UNBREAKABLE  
• WASHABLE FROM HEAD TO TOE • GUARANTEED MECHANISM  
She's really 7 dolls in 1! She's dressed in an exquisite wedding gown of shimmering rayon satin—and has a complete trousseau suitable for any "dress-up" occasion. You can change her costume, wash and wave her hair in any style. She turns her head as she walks. Unbreakable, washable plastic body. Sparkling "go-to-sleep" eyes. She sits up and stands. Fully jointed, finely detailed, 19 in. high. You get all 7 outfits and this lovely doll at one unbelievable low price.

© Niresk Industries, Inc., 4757 Ravenswood Ave., Chicago 40, Ill.

**ROOTED  
SARAN  
HAIR**



Set Hair any Style

## MONEY BACK GUARANTEE

Niresk Industries, Inc., Dept. BTD-8  
4757 Ravenswood Ave., Chicago 40, Ill.  
Please rush glamorous Hollywood Bride doll and 7 outfits at \$5.95 plus C.O.D. postage. Full purchase price refunded if not satisfied.

NAME \_\_\_\_\_

ADDRESS \_\_\_\_\_ (please print)

CITY \_\_\_\_\_ ZONE \_\_\_\_\_ STATE \_\_\_\_\_

To save postage, I enclose \$5.95—ship prepaid.

I enclose \$1.00 deposit—will pay balance C.O.D. plus postage.

(In Canada \$7.95.) Niresk, 214 Main St., Toronto 13, Ont.



# Give Cartons of Pleasure for Christmas



## CAMEL

Year after year, America's most popular cigarette. For more pure pleasure — give Camels! No other cigarette is so rich-tasting, yet so mild!

## WINSTON KING SIZE

FILTER TIP — Now one of America's most popular cigarettes! Finer filter, finer flavor, easy-drawing — Winston tastes good, like a cigarette should!

## CAVALIER KING SIZE

The king-size cigarette with two-way smoking pleasure: feel that lightness . . . taste that flavor!

## PRINCE ALBERT

SMOKING TOBACCO — America's largest-selling smoking tobacco! Give mild, tasty Prince Albert in the 1-lb. tin to pipe smokers on your gift list.

