

THE
Elks
MAGAZINE



DVANE
BRYERS

E DECEMBER 1956
Report on 1957 Cars
BY JOSEPH H. WHERRY

ALAN AMECHE, BALTIMORE COLTS, DISCOVERS WHY

VICEROYS Are Smoother!



Alan "The Horse" Ameche drives off left end on one of the galloping runs that made him the top National Football League ground gainer. After a rough game, relaxing with a Viceroy, he says . . . "Viceroy gives me the smoothest taste in smoking!"



Here's why Alan Ameche finds Viceroy are smoother: Only Viceroy has 20,000 filters in every tip...twice as many as the other two leading filter brands—the *most* filters for the *smoothest* taste!

Twice As Many Filters

in every Viceroy tip as the other two largest-selling filter brands

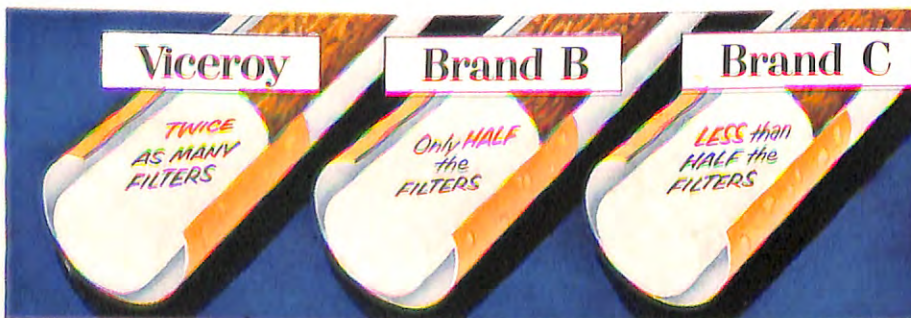

VICEROY'S EXCLUSIVE FILTER IS MADE FROM PURE CELLULOSE—SOFT, SNOW-WHITE, NATURAL!





TOM WRIGLEY WRITES FROM WASHINGTON



A UNEASY CALM has settled over Washington as Congress prepares to open a new session. Looming in the background is a far-reaching scheme on the part of all communist nations, abetted by some of our democratic "Neutrals", to get Red China in the United Nations in 1957. Some in official circles here say the Reds can be kept out for another year. All realize that support for her admission is steadily gaining strength. It takes a two-thirds vote of the UN National Assembly to break the barrier and oust the Nationalist China delegation. The present line-up is 46 against, 24 in favor and six non-committal. Disturbing fact, however, is that a number of the 46 now lined up with the United States are luke-warm or wavering, including three of the 20 Latin-American countries which thus far have stood staunchly on our side. First step to admit Red China will be a move to place the question of China's representation before the annual General Assembly. Only a simple majority is needed. If that is won the two-thirds vote on admitting Red China will follow. Such a victory would be a terrific blow to the United States. Headquarters of all national patriotic organizations in Washington are aware of the consequences. They are alerting their memberships to the danger. At annual meetings soon to be held in 1957, resolutions are being planned demanding this nation resign from the U.N. if Red China, branded as an illegitimate regime and a brazen violator of the Korean armistice, is admitted to the organization.

TO SWAP FAMOUS SHIP

The *Enterprise*, famous aircraft carrier of World War II, is up for sale by the Navy for junk. Veteran of 20 Pacific battles, the *Enterprise* shot down 911 Jap planes, sunk 71 ships and damaged 192 others. The flat-top is obsolete now.

PRESIDENTIAL HOT DOGS

U. S. Secret Service in protecting the life of the President keeps a watchful eye on any food or beverages offered the chief executive when he is away from the White House. At the Army-Navy football game, for instance, if the President wants a hot dog, it is bought at random at one of the stands and taken to the Presidential box. Hot coffee will likely come from thermos bottles prepared in advance. Secret Service operatives carefully check the stadium

in advance, the area around the President's box getting a real going over. And at a game, or theater or other public event where the President is a spectator no one knows how many Secret Service men are stationed at vantage points—except Secret Service Chief U. G. Baughman.

4000 MPH PLANE

In two years USA expects to have a rocket research plane flying faster than 4,000 miles an hour and able to climb 200,000 feet. It's in the planning stage now and will be the X-15. It will fly so fast and so high present type controls will be of little use. Small rockets in wing tips will control direction.

SEE THE SATELLITE

As an added attraction for visitors, Washington will be a viewing point for the earth satellite. Scientists at the Navy say it will be visible at certain times near twilight through binoculars.

RAH FOR BABIES

Birth rates are up in every state and college graduates are joining the boom the Population Reference Bureau reports. A generation ago married college students and grads were mostly in the no-child or one child class. Now many are three or more child families. Moreover, today's graduates are starting their families earlier.

DUCKY DEAL

Ducks have never been a surplus commodity in this country like chickens and turkeys. Production just waddles along and it's duck soup for those who raise the quackers. But ducks, on paper at least, are now a surplus, and the story is this. Agriculture agreed to sell Germany \$1,200,000 worth of surplus chickens and turkeys, but the German hausfrau said they would rather have ducks. So a deal was made whereby the government will pay a 5.5 cent a pound subsidy on ducks shipped to Germany, same as for chickens and turkeys and they will be sold in a combination arrangement. The whole deal is expected to be completed by Christmas.

OUR SHRUNKEN WORLD

According to one way of figuring it, the world is now only 35 miles around. So says Justin Blackwelder, executive secretary of the Atlantic Union Committee. The AUC is working to build stronger political

and economic ties among democratic nations. To illustrate how small the world is, Mr. Blackwelder says it took a courier 24 days to rush a copy of the Declaration of Independence 350 miles from Philadelphia to South Carolina in 1776, or .61 miles an hour. Fast commercial planes now fly 420 miles an hour or 688 times as fast. The earth's circumference of 24,000 miles divided by 688, represents 35 miles compared to travel in 1776 if you figure it that way.

OFFICES FOR FREE

Under certain conditions the Library of Congress provides rooms or desk space free of charge to those engaged in research. Landon P. Marvin, Jr., holds the record for occupancy. He has had free offices in the Library for nine years and at present has four rooms, 139-142 inclusive. Mr. Marvin is engaged in legislative research, sponsored by various senators and representatives. When one withdraws, Mr. Marvin comes up with another. Rep. Daniel Flood of Pa., withdrew sponsorship last August, and Senator Estes Kefauver took over. They call Mr. Marvin the "indestructible tenant."

CAPITOL CORNERS

Stop lights to allow only one-way traffic are planned for Washington for use in case of enemy attack . . . "Siamese" twins, daughters of Mr. and Mrs. Raymond Buntion of Bitler, Tenn., were admitted to National Institute of Health Hospital for a study to see if they can be separated . . . Girl Scouts had to collect D.C. sales taxes on their annual cookie sales . . . Washington Cathedral is getting a statue of George Washington on horseback, gift of the late James Sheldon, New York banker . . . Federal government will spend \$65,000,000 on cancer research in the year ending next July 1, U.S. Surgeon General L. E. Burney reports . . . Washington last year had 2.6 deaths for each 10,000 vehicles, lowest in the country . . . Veterans of Foreign Wars will erect a \$1,500,000 memorial building on Maryland Ave., N.E. . . Dividends on World War II government insurance for veterans will be 13 per cent higher next year . . . U.S. Treasury borrows \$1.6 billion every week in short term "Treasury Bills" . . . Virginia plans to invite Queen Elizabeth II to the 350th anniversary of the founding of the Jamestown colony next year.

1957 WARNING from The Wall Street Journal

During the next three months, you will need to keep up to the minute on news affecting your future and the future of your business.

Because the reports in The Wall Street Journal come to you DAILY, you get the fastest possible warning of any new trend that may affect your business and personal income. You get the facts in time to protect your interests or to seize quickly a new profit-making opportunity.

To assure speedy delivery to you anywhere in the United States, The Journal is printed daily in five cities—New York, Washington, Chicago, Dallas and San Francisco. You are promptly and reliably informed on every major new development regarding Prices, Taxes, Consumer Buying, Government Spending, Inventories, Financing, Production Trends, Commodities, Securities, Marketing and New Legislation.

The Wall Street Journal has the largest staff of writers on business and finance. It costs \$20 a year, but in order to acquaint you with The Journal, we make this offer: You can get a Trial Subscription for three months for \$6. Just send this ad with check for \$6. Or tell us to bill you. Address: The Wall Street Journal, 44 Broad St., New York 4, N. Y. EM-12

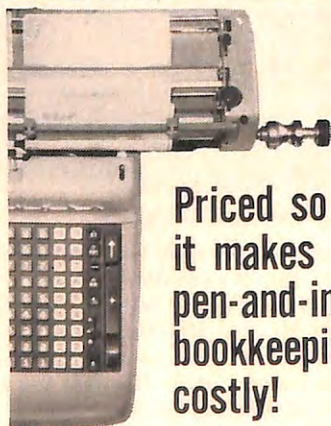

Priced so low,
it makes
pen-and-ink
bookkeeping
costly!

Burroughs Director Accounting Machine

Here's the machine and the plan that put back the dollars that old-hat, pen-and-ink bookkeeping takes out. It's the Burroughs Director Accounting Machine and the complete Director Accounting Plan for every business. The low-cost machine gives you fast front feed, automatic carriage tabulation, short-cut keyboard, and many more big machine features.

—Send for FREE booklet!

BURROUGHS CORP.
Detroit 32, Mich.

Please send me your new booklet: "A Complete Accounting Plan for Burroughs Director Accounting Machines."

EM-43

NAME _____

ADDRESS _____

CITY _____ ZONE _____ STATE _____

THE Elks

VOL. 35

MAGAZINE

No. 7

NATIONAL PUBLICATION OF THE BENEVOLENT AND PROTECTIVE ORDER OF ELKS OF THE UNITED STATES OF AMERICA. PUBLISHED UNDER THE DIRECTION OF THE GRAND LODGE BY THE NATIONAL MEMORIAL AND PUBLICATION COMMISSION.

THE ELKS NATIONAL MEMORIAL AND PUBLICATION COMMISSION

JOHN S. McCLELLAND
Chairman
EMMETT T. ANDERSON
Vice-Chairman
JAMES T. HALLINAN
Treasurer
WADE H. KEPNER
Secretary
CHARLES E. BROUGHTON
Asst. Secy. and Asst. Treas.

JAMES R. NICHOLSON
General Manager

LEE C. HICKEY
Editor

REGINA M. FISHER
Associate Editor

JOSEPH C. JONES
Art Editor

GENEVIEVE G. CONOVER
Advertising Production

W. H. MAGRATH
Controller

JOHN SCHMITT
Circulation Manager

EDWARD FAUST
Promotion Manager

EDITORIAL OFFICES, 386 Fourth Avenue, New York 16, N. Y.

CONTENTS FOR DECEMBER, 1956

COVER BY DUANE BRYERS

TOM WRIGLEY WRITES FROM WASHINGTON.....	1
ONE FOR THE MONEY.....	Octavus Roy Cohen 4
A CHRISTMAS MESSAGE FROM THE GRAND EXALTED RULER....	6
THE ELKS MAGAZINE REPORTS ON 1957 CARS	
Joseph H. Wherry	7
BASEBALL'S MR. FIXITS.....	Harold Rosenthal 12
ELKS NATIONAL SERVICE COMMISSION ACTIVITIES.....	14
PAST GRAND EXALTED RULER CHARLES E. BROUGHTON.....	15
LODGE VISITS OF FRED L. BOHN.....	16
FOR ELKS WHO TRAVEL.....	Horace Sutton 18
NEWS OF THE LODGES.....	20
OLD TIMERS IN ELKDOM.....	23
NEWS OF THE STATE ASSOCIATIONS.....	24
ELKS FAMILY SHOPPER.....	26
ROD AND GUN.....	Dan Holland 36
IN THE DOGHOUSE.....	Ed Faust 38
TRAVELGUIDE.....	42
ELKS NATIONAL FOUNDATION—"The Joy of Giving".....	45
FREEDOM'S FACTS.....	46
ELKS WORKSHOP.....	Harry Walton 54
EDITORIAL.....	56



ADVERTISING OFFICES



CHICAGO 1
360 North Michigan Avenue
STATE 2-6662

NEW YORK 16
386 Fourth Avenue
MURRAY HILL 4-5495

LOS ANGELES 17
1709 West 8th Street
DUNKIRK 8-5187

SAN FRANCISCO 4
927 Mills Building
EXBROOK 2-4073

PORTLAND 4, ORE.
217 Times Building
CAPITOL 7-3718

CHANGE OF ADDRESS: POSTMASTER—Please mail Form 3579 notices to: THE ELKS MAGAZINE, 386 Fourth Avenue, New York 16, N. Y.

Members are asked, in changing address, to send this information (1) Name; (2) Lodge number; (3) Membership Number; (4) New address; (5) Old address. Please allow 30 days for a change of address to be effected. THE ELKS MAGAZINE, Volume 35, No. 7, December, 1956. Published monthly at McCall Street, Dayton, Ohio by the Benevolent and Protective Order of Elks of the United States of America. Entered as second class matter November 2, 1940, at the Post Office at Dayton, Ohio, under the Act of August 24, 1912. Acceptance for mailing at special rate of postage provided for in Section 1103, Act of October 3, 1917, authorized May 20, 1922. Printed in Dayton, Ohio, U.S.A. Single copy price, 20 cents. Subscription price in the United States and its Possessions, for Elks \$1.00 a year; for non-Elks, \$2.00 a year; for Canadian postage, add 50 cents a year; for foreign postage, add \$1.00 a year. Subscriptions are payable in advance. Manuscripts must be typewritten and accompanied by sufficient postage for their return via first class mail. They will be handled with care but this Magazine assumes no responsibility for their safety. Copyright, 1956, by the Benevolent and Protective Order of Elks of the United States of America

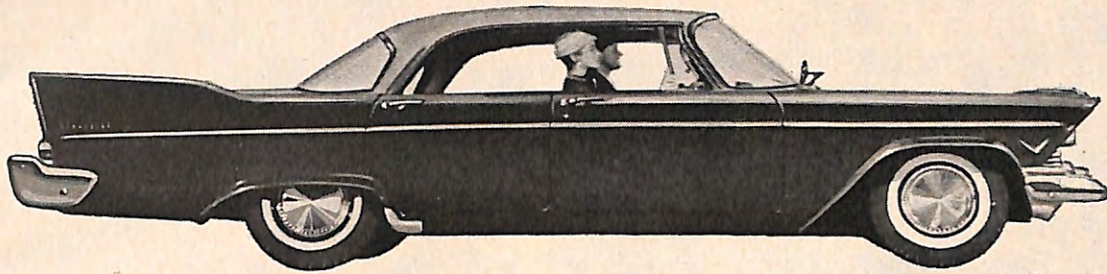

1957 PLYMOUTH

NEWEST NEW CARS IN 20 YEARS

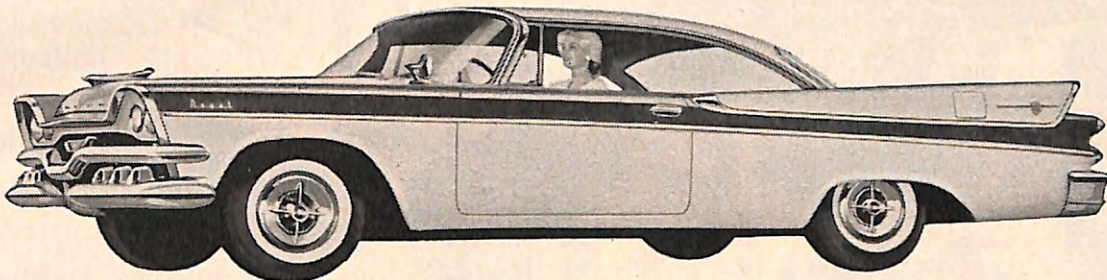

1957 DODGE

WITH THE NEW SHAPE OF MOTION



1957 DE SOTO

WITH THE NEW TORSION-AIRE RIDE



1957 CHRYSLER

AND NEW PUSHBUTTON TORQUEFLITE



1957 IMPERIAL

CHRYSLER CORPORATION  **THE FORWARD LOOK**

COPYRIGHT 1956 BY CHRYSLER CORPORATION



By OCTAVUS ROY COHEN

ILLUSTRATED BY WALTER M. BAUMHOFFER

**Dave knew the voice,
but he'd never
before heard it when
it was quivering
with terror.**

ONE FOR THE MONEY

THE jangling of the telephone shattered the quiet of the tiny apartment.

Dave Norris glanced at the mantel clock as he reached out to answer the call. Five minutes before eleven p.m. He said, "Hello," and then tensed as he caught the desperate urgency of the voice at the other end.

The voice said, "Dave! I need help!"

It was a woman's voice. A young woman. Dave knew who it belonged to all right, but he'd never before heard it when it was quivering with terror. Ann Sherman was usually so quiet and self-controlled, so calmly confident in any situation.

"Steady, kid . . ." That was Dave Norris trying to reassure her. "What's wrong?"

She said, "It's Mr. Waring. He's dead. Murdered."

"You're sure, Ann?"

"Of course I'm sure. I'm a nurse. No heartbeat. No pulse. He's out there in the patio . . . Can you come right away?"

"Could it have been suicide?"

"No. I'm positive. The gun is lying a dozen feet away from where he was sitting."

"You haven't touched anything?"

"Just Mr. . . . just the body."

"Have you called the police?"

"No. I'm frightened. I want you here with me."

"I'm on my way as of right now." He was keeping his voice calm. "Meanwhile you must call the police. You must: Understand? This minute."

"Oh Dave . . . I'm so scared."

"Do what I told you. That's how it's got to be. Tell them everything you know: everything you (Continued on page 44)

Her hands were icy. She was looking everywhere except at the figure in the green chair on the patio.





Merry Christmas

"And lo, they wrapped Him in swaddling clothes and laid Him in a manger, because there was no place for them in the inn."

Christ, the King of Kings, was born into this world in poverty and humility in the shabby stable of Bethlehem. A gracious God so designed that His Son, the Savior, be born to us in such humble surroundings to teach man His way.

Tinsel and toys, the cheery fireplace, footprints in the crunchy snow, steaming platters of turkey and goodies, friendly handclasps and warm greetings, all are typical of the American way of saying, "Merry Christmas."

But under it all lies the greater joy that comes only to those who have given of themselves to the needs of a friend.

Elkdom is dedicated to such noble efforts and I devoutly hope that each and every one of us enjoys the full fruits of the season during this month of the Christmastide and every other month of our lives.

For then, and only then, may we conscientiously say,

"Peace on Earth to Men of Good Will"

Very sincerely,

Fred L. Bohn

FRED L. BOHN
Grand Exalted Ruler

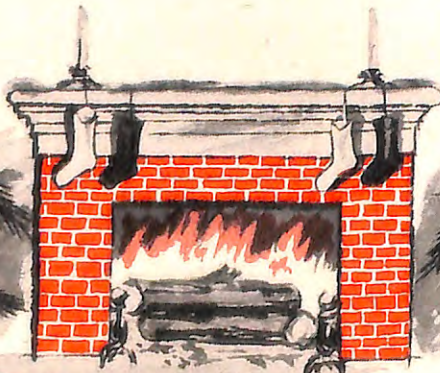



Reports on 1957 Cars

BY JOE H. WHERRY

Photographs by the Author

IN THE JANUARY, 1956, issue of The Elks Magazine, this writer reported the auto industry's target to be around 8-million cars for the year. Before last winter was spent it was evident that the sights were too high. So, for 1957, the industry, while investing nearly a billion dollars in development and new facilities, is playing it cautiously without making unsupported claims. 1957 sales "guesstimates" range from 6½ to over 7-million cars.

In my opinion top sales place will be retained by Chevrolet but the expanded and double-barrelled Ford line will make it a hot contest. I would presume Buick to hold third place, but the Plymouth will begin to close the gap. The expanding appeal of sports type cars will see Chevrolet placing increased emphasis on the new Corvette which will be outsold by Thunderbird simply because of the larger production of the latter, but I believe that the family-sized Studebaker Hawk will out-sell both of the former put together.

As always, each new model has enough new features to fill a book. This year's crop, though, have enough important innovations to warrant skipping comment on the rather obvious styling changes. So, here briefly are the outstanding improvements that will make your new car safer, more comfortable, and, in hushed tones, faster:

AMERICAN MOTORS

A new and highly developed V-8 engine of AMC's own design and manufacture promises to bring the performance of the Nash Ambassador and Hudson Hornet series up to meet the big competition. Rated at 255-horsepower, the big Hudson and Nash share body shells. As a matter of fact, this should cause no alarm in the public's mind, for major makers like Chrysler and GMC apply this same practice of having only two or three bodies for their entire range of mass-produced cars. Not a new innovation but worth mentioning is the *integral* form of structure first placed in regular series by Nash in 1940 (Chrysler in '33 and Lincoln Zephyr in '37 tried this system but despite its technical excellence discontinued it within a few years). Eliminating the traditional chassis frame, body and frame members are

- PERFORMANCE
- STYLING
- INNOVATIONS

welded together by 9,000 welds into one solid box-like structure of superior strength. By next year there will be additional adherents to this type structure, for its benefits and rattle-free life are much respected by the Big Three.

AMC's large cars retain the soft ride, have unseen suspension improvements which increase roadability, and their claim to being fine travel cars is upheld by continued availability of the reclining seats. The most noticeable new development is on the Nash: it is one of two cars with vertically displaced dual headlights.

The compact Rambler, no longer a small car after its body change last year, remains big inside, comparatively smaller than other so-called small cars outside, making it tops for crowded traffic, pre-war garages, and average families on a budget. Like its bigger brothers, Rambler's price will be slightly reduced contrary to the general upward trend. Now the buyer has the choice of sticking with the 125 to 135-horsepower 6-cylinder engine, or he may specify a small version of AMC's V-8 that develops 190 h.p. With this power, economy will still be excellent and performance is, not to coin a term, hot.

Stylewise, little has been done to any of AMC's cars other than shifting the chrome. On the Rambler the bucket-handle look of the roof on the sedans has been eliminated. The bulge at the rear is caused by a girder structure that greatly adds to strength, but no longer is this hoop accented by chrome and two-toning. The big AMC cars now have the smaller wheels, the Rambler retains 15-inchers. With resale value of the Rambler high, that of the Nash and Hudson rising in some regions, these cars are better buys than most realize, for they are tough, easy to handle, and exceptionally long-lived. I suspect the V-8 Rambler will be one of the year's surprise cars.

CHRYSLER CORPORATION

Chrysler is still valiantly working on that 20-per cent of the market that management feels to be rightfully theirs. If they don't make it with their new line, it will surprise many automotive writers. Biggest news out of Highland Park is that
(Continued on following page)



The author, Detroit Editor of "Motor Trend," regularly drives all new models each year; here he is with one of Mercury Division's top engineers, Jerry O'Shea, at left, examining new type carburetor air filter. In the background can be seen Ford's Dearborn proving grounds.



All five Chrysler cars from Plymouth to big Imperial now feature torsion bars rather than traditional coil springs for low and firmer front suspension. Arrows point to the long longitudinal torsion bars which twist with front wheel up-down movements rather than compress.

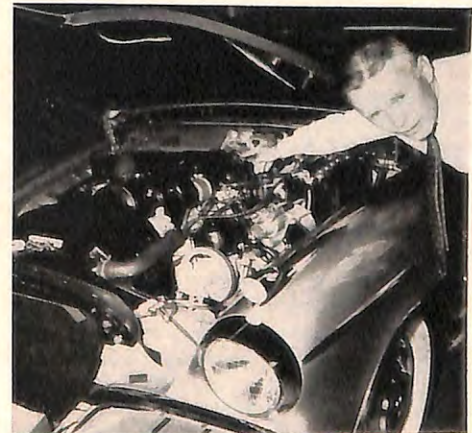

Mike De Blumenthal, Studebaker's Chief Research Engineer, points to the super charger covering carburetor; this pressurizes extra air through carburetor, increasing combustion efficiency of already very warm V-8 engine—gives performance hot enough for anyone to brag about.

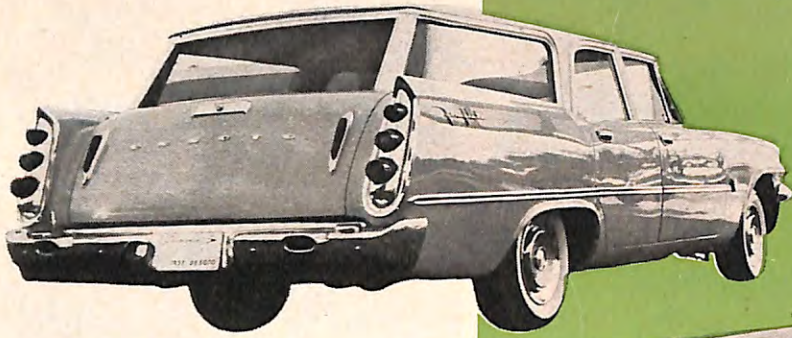

IMPERIAL has 325 horses in all models, a windshield that wraps just a wee bit over the top, and curved windows on each side. The Imperial's new look should win much favor for its distinction and over-all good taste.



DE SOTOS are all-new too; have engines with power available from 245 to 295 h.p. as car hits market. One can expect a super job to appear shortly with increased output. The Firesweep in a new short wheelbase (122 inches) model; Fire dome and Firelite continue to share 126 inch chassis but bodies are same. This is the "Shopper" Firelite wagon.



DODGE is another car definitely now in the super class with V-8 power optional up to a whopping 310 h.p. for those with heavy throttle foot. Most distinctive angle on this all-new car is from rear where unusual fins, called "Swept Wings," will cause many a double-take.

CHRYSLER has a new series too, with the Saratoga again on the scene with 295 h.p. to take its place between the Windsor (285) and the luxury New Yorker (325 h.p.). All have same chassis, share bodies, but have distinctive trim. Dual headlights on the Chrysler are optional.



PLYMOUTH, like rest of Chrysler family, is all new, with wheelbase expanded to 118 and 122 inches for sedans and station wagons respectively. Horsepower of several Six and V-8 engine options was unavailable at writing, but they will climb into high ratings with at least 225 likely in top Belvederes. New torsion bars help handling.



all five makes are completely new—new chassis employ torsion bars for the front wheel suspension. Thus, by eliminating the long coil springs, a lower over-all height is achieved. There are now few cars within whispering distance of five feet. Interior space is not badly affected—where there is a decrease, it's slight and in headroom only. From the Plymouth through to the swank Imperial, a great improvement in roadability is readily noticed with less lean on corners, less effect from cross winds, more level stopping, and a more secure feeling.

A new three-speed automatic transmission, called TorqueFlite, is available throughout the line and will probably completely displace the slightly less costly but not so economical or fast accelerating two-speed PowerFlite unit used the past several years. All cars equipped with either automatic drive have the buttons in the same location as previously, but the Imperial arranges them vertically making for easier selection.

Chrysler

Stylewise, the Imperial is the knockout of the line with a sloping, as opposed to squarish, rear deck. Trunk space is not materially affected because of the lower positioning of the body. The big Imperial is about 6-inches shorter overall than in '56 and it's better than 3-inches lower. With the Crown Imperial and a new custom Le Baron limousine available, Imperial is searching out the very high priced customer who wants something really different.

Plymouth and Dodge are larger. In fact the Plymouth station wagons have 122-inch wheelbase, the same as the Dodge and the smaller of the three De Soto models, the new Firesweep, which is actually assembled in the Dodge plant because of its basic likeness to the latter. Power

ranges from less than 150 h.p. on the Plymouth and Dodge Six to a whacking 325 on the Chrysler New Yorker and Imperial models. Most of the V-8 powered cars have dual exhausts, but, except on the De Soto, the tailpipes are beneath the bumper. Interiors have fewer protruding gadgets, the Imperial's windshield curves when viewed from the side, and so do the side windows of this expensive car.

FORD MOTOR COMPANY

On the top, with increased sales during 1956 (something only the modest Rambler and the rich Cadillac can claim), the Lincoln retains the new body and frame of last year. Horsepower is now 300, but some rather extensive suspension improvements have made the Lincoln handle even better than formerly, and that was good.

Mercury is all new, the top model being the new Turnpike Cruiser (which we cannot show, unfortunately, due to a belated announcement date that follows this issue). It will have nearly as much power

as the Lincoln. Much larger, the all new Mercury makes one wonder where Ford will sandwich the much rumored "E" car late in the year when it will probably come out as a '58 model. Mercury's innovations are two: a free-wheeling fan, optional of course, that cuts out and ceases to waste road horsepower when there is no danger of engine overheating, and an "Air Cushion" mounting for the forward ends of the rear springs. A doughnut-like rubber affair, actually like a tiny tire, cradles the forward spring trunnion and the ride is noticeably smoother under all conditions whether travelling light or loaded. Optional is a limited slip rear axle (originated by Packard last year) which makes getting stuck a less risky business; this is available on Lincoln, too.

The Ford, now, for the first time, has two separate sizes, a 116 and a 118-inch wheelbase model with a good half-foot difference in length. The shorter is the Custom line, the longer the Fairlane. You can still get a good performing Ford Six, but power happy public has caused Ford to go to 245 h.p. in the luxury Fairlane 500 and comparable station wagon models. The bodies, chassis and the works are all new. In fact the new chassis side rails are now full width to allow lower heights—the body sets down between the rails—without decreasing interior space or headroom. The Mercury has a similar wide frame—Lincoln got its wide chassis in '56.

The Lincoln, which has vertically mounted dual headlights (the Mercury Turnpike Cruiser will have these too as well as a roll-down rear window and roof top turn signals), is sticking to 15-inch

wheels, and will, in my opinion, be the stock car to beat again if Mexico decides to run off another international road race. Actually, Lincoln is no faster than in '56, but the handling is improved and the entire car has an air of enlightened conservatism about it. Only the automatically shifted Mercury has push buttons—these are placed as on the Chrysler cars but an addition is the parking brake control incorporated into the console.

GENERAL MOTORS

Still selling more than 50-per cent of the total market, GMC is preparing even more efficient production. Big scoop here is that Chevrolet will be the first with fuel injection at extra cost on V-8 powered passenger cars and on special Corvette sports cars. F. I. eliminates the carburetor, channels the fuel directly into each individual cylinder. Result is faster acceleration, easier starting. You can forget about the inconvenience of a possible vapor lock when you stop on a hot day, but you can expect to await delivery and to pay more—F. I. will be a special order accessory.

Both Chevrolet and Pontiac are facelifted for '57, but considerable restyling can be done with chrome, as we all know. From Oldsmobile up the GMC line has all new bodies and frames. The latter are full width as in the entire Ford line and

the net gained is the same: lower overall height without affecting interior space, greater rigidity, lower center of gravity, and a step-down effect for rear seat occupants.

Improvements have been general in the automatic transmission department, but as this is written, we have no intelligence concerning possible use of push button controls. Personally, I doubt if there will be any change in the lever control, and frankly, the lever still remains the most positive means and does not require one to remove more than a finger from the wheel.

Chevrolet has long needed an improved automatic transmission. This year they have it in the new TurboGlide, which is more economical, faster, and in skilled hands can be tossed around with the ease of a conventional manual shift. Across the board there is higher compression. While Chevrolet's horsepower will be at least 280 with fuel injection, the standard V-8 engine will be competitive with Ford—that means nearly 250.

At the top of the ladder is the all new Cadillac with the special series convertible and hardtop Eldorado model which have 325 horsepower. I'm glad to be able to report that GMC's largest cars now handle much better. They have the maneuverability of many smaller cars and much of this results from incorporating modified and improved versions of Chevrolet's successful ball joint front suspension which not only requires less maintenance but trims up the ride while still allowing a comfortably soft one.

(Continued on following page)

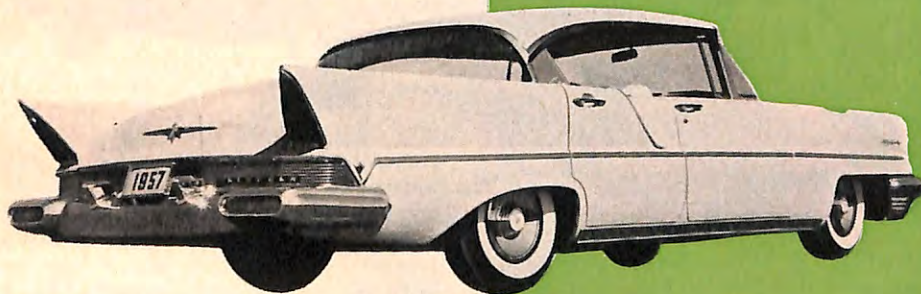

MERCURY: A good foot longer for 1957, new Mercury has upped power too with options running from 255 to 290 h.p. New separate Ford manufacturing division, this car features sculptured rear quarter panels ending in canted fin, huge tail lights. Styling is in line with unannounced (at press time) Turn-Pike Cruiser. Here, a big car, has many engineering innovations but buyer will have to part with more dollars than previously for the extra icing.

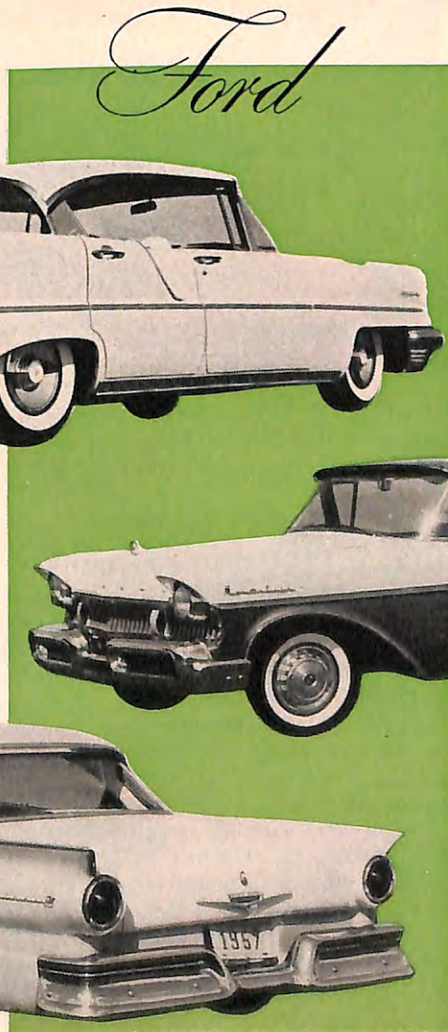

LINCOLN. Basically unchanged for '57 except for dual headlights (over and under like Nash) and increased power (now 300), Lincoln's greatest style change is in the rear where enormous high and canted fins impart fleetness. Note how chrome trim wraps around rear fenders, looks like grille.

FORD Fins canted outward signify the advent of jet age styling in the Ford studios. Two wheelbases are offered for 1957 with Custom and Station Wagon line sharing one chassis, the stylish Fairlane getting the longer of the two. Fords are no longer a small car.

BUICK: 300 horses 'neath the hood will make this Century hardtop one of fastest production cars. 3 inches lower, but with same headroom, Buick line starts with 250 h.p. Special; should retain remarkable popularity with reasonable prices.

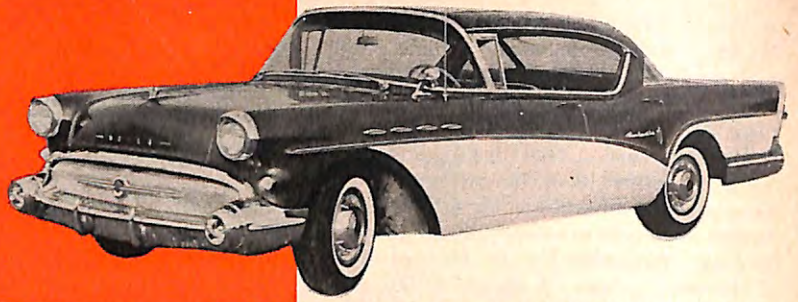

OLDSMOBILE: New throughout with 277 h.p. in all series, the Oldsmobile has returned to ranks of station wagon makers with colorful Fiesta and hardtop wagon models, photos of which were unavailable at press time. 2 inches lower, 5 inches longer, car still looks like itself in spite of sweeping changes. (GMC photo)

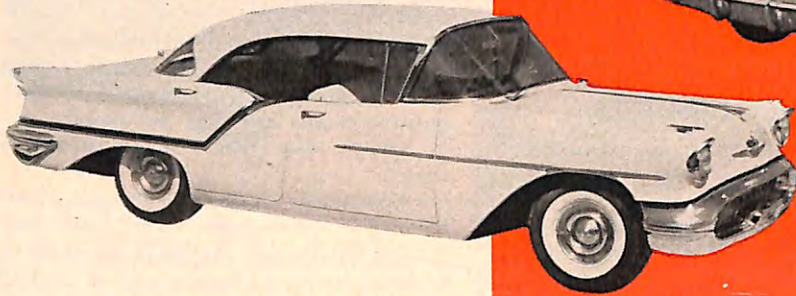

PONTIAC Star Chief, at right, is star of line that, while not all new, is more than slightly changed: new body styling accentuates longer, lower look. Stainless steel side sweep shaped like guided missile. Individual performance of engines range from 252 to 270 horsepower in four model series.



CHEVROLET: Still compact and tastefully styled with less trimming than the competition, the top selling car is lower, sleeker, and features engines ranging from economical sixes to some of the industry's hottest and most efficient V-eights. Styling has that popular sports car flair. (GMC photo)



CADILLAC: There's much gained from sports car styling on this 320-horsepower Eldorado Seville. Smooth, big, long, costly, the Cadillac line includes every body style except wagons.

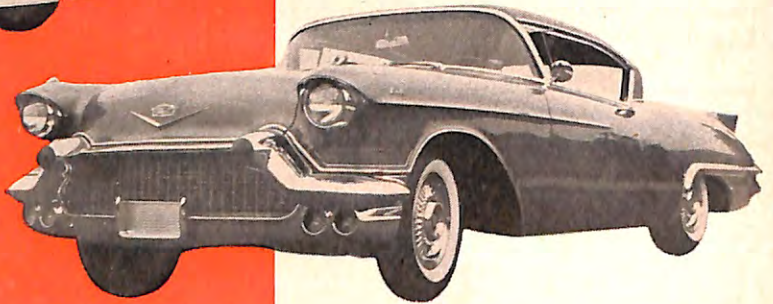

STUDEBAKER-PACKARD

There will be a 1957 Packard—but we cannot illustrate it since the release date is in January. It will be built in South Bend, Indiana, in the Studebaker plant and it will include traditional Packard features. Designed to appeal to those who prefer to buy outside the mass market, both Studebaker cars and the Packard will retain identity and be distinctive in comparison to others.

Curtiss-Wright has not bought S-P; together these two firms have entered into a management consulting arrangement whereby Studebaker will have the advantage of wise counsel and marketing advice and assistance. S-P's defense facilities on the West Coast have been purchased by C-W as have some of the South Bend installations. The entire S-P operation is being pulled in tightly to reduce overhead. The new president, Harold E. Churchill (for many years chief engineer—he originated free-wheeling which lead to overdrive, which in turn paved the way for modern automatic transmission) says that the program now in hand is to aim at gaining a 1.58 per cent piece of the mar-

General Motors

ket. This is said to be sufficient to put S-P into the black. For a company that has been a style leader, the originator of such items as the hill-holder (which holds the car on a hill without need of keeping brake pressure) it seems to us that public confidence and support is deserved.

The Studebaker cars are only moderately changed, mainly by restyling the exterior trim which, incidentally, is stainless steel rather than corrosion-prone chrome. Top model is the Golden Hawk, which has the largest Studebaker engine supercharged to develop 275 horsepower. This is the first supercharger installation in a sports type car since pre-war years. A supercharger rams a greater quantity of air into the carburetor, resulting in greater efficiency and a high power output.

The Silver Hawk V-8 turns 225 h.p. with the same engine minus the supercharger. For the economy-minded who want sports car appearance and room for the family, the Silver Hawk Six has the

venerable 101 h.p. Champion engine. Sedans include the Champion Six, the Commander with 180 to 195 h.p., and the President with 210 to 225 h.p., while the good selling line of station wagons has been expanded to include a very chic 4-door model.

Studebaker, alone, in the low-priced range, has the very useful limited-slip rear axle as an option. 15-inch wheels have been retained and the ride and handling characteristics have been notably improved in the whole line by means of variable-rate springs. Designed so that the ride is soft regardless of the load, this is a Studebaker first. Here again the station wagon has benefited the most. In my opinion, the ride cannot be distinguished from that of a conventional sedan. If the public wants, as indications would lead one to believe, high performance as first consideration, then S-P is ready to deliver the goods with a top power line of Hawks that will top 120 and roomy though quite compact sedans that will reach 110 with little difficulty.

We would like to see the smaller firms prosper—they have done as much pioneer-

Studebaker-Packard

STUDEBAKER Commander V-8 Tudor typifies effort toward Studebaker's setting sights on low priced market whose buyers want something distinctively styled but with all the power options and conveniences of mass-produced makes. Power options range from the 101 h.p. Champion Six to the 225 h.p. V-8 President.



STUDEBAKER Golden Hawk supercharged, 275 h.p. four-five seater sport type ball of fire. On its own in direct competition with two other well-known sport type two-seaters, the Hawk line has sold well, retains resale. Average owner has been found to be family man with two children who have just one car.

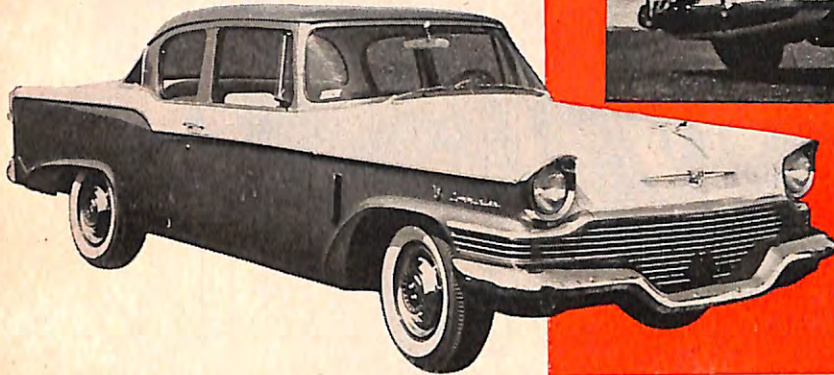

ing as the larger groups. Should they eventually fail, which I for one refuse to believe will happen, the greatest default will be on the side of the public. The more competition, the better will be the cars of the future.

As regards the future, don't be surprised if the new station wagons, most of which will appear after the first of the year, gain

somewhere close to 15-per cent of the market. Many will have longitudinally ribbed roofs, they will have all the luxury gadgets, and they will be as comfortable as any sedan.

As for gas turbine engines, don't hold your breath—they're still several years away. In the meantime, there will be increasing numbers of special cars (see

Chrysler's low production luxury sportster, the Dual-Ghia) both by small and the largest manufacturers. Also, not too far in the future is a television set—personally I hope this item is in the back seat for safety's sake.

The '57 cars are the best yet, but 1958 will bring even more startling developments.

American Motors



RAMBLER, which got its new styling last year, is changed only in small details. Its resale value remains deservedly high. New for '57 is American Motors' own 190 h.p. V-8 engine which makes car truly a hot performer. For economy minded, the reliable 6-cylinder engine now develops up to 135 h.p. and gives good performance; seats six.

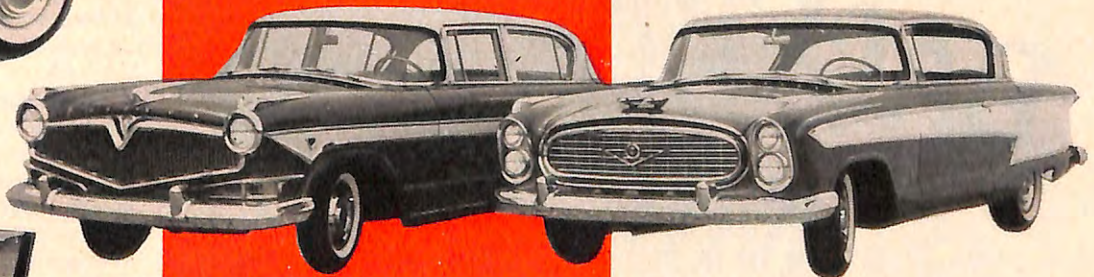

HUDSON (left) and NASH (right) now have their own new and thoroughly tested 255 h.p. V-8 engine which enables them to perform with the rest. Exceptionally roomy, both cars offer distinction while retaining traditional domestic dependability and performance. Nash has dual headlights.

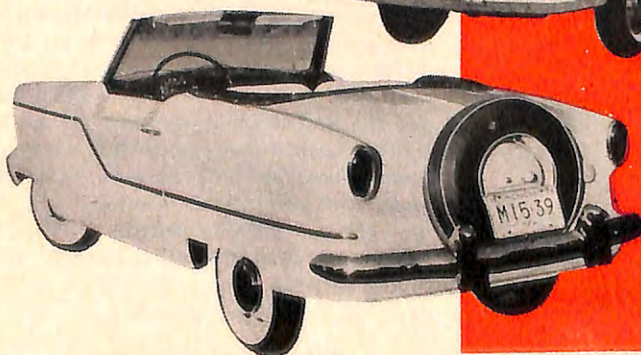

METROPOLITAN by American Motors is curious, though handy, combination of Anglo-American cooperation. Second only to Volkswagen in small car sales, the Metro seats two adults and two children. Available at low prices in both hardtop and convertible models, this is an ideal second car for shopping and utility.



BASEBALL'S MR. FIXITS

BY HAROLD ROSENTHAL

A road secretary for a major league ball club has to be a chameleon kind of fellow.

LONG before the current do-it-yourself craze had progressed beyond the 89-cent hammer and handful of nails stage, a small but dedicated group of Mr. Fixits roamed the country, devoting their 24-hour energies to cleaning-up, patching-up and smoothing-out the rough spots in the nation's national pastime. Baseball's dime hot dog has given way to the 25-cent one-biter; some fiend has jacked up the price of ball-park peanuts to 15 cents, and the only people who sit in the bleachers now apparently are society folk just out slumming for a thrill, but the Mr. Fixits have never swerved from their tasks.

They are the sixteen road secretaries, one to a major-league team. From the day the first candidates report for spring training they seek to guide their flocks of country boys and city sharpies, of music lovers and comic-book devotees, and all the various other personalities that go to make up a major-league entourage, past sundry Scyllas and Charybdises right down to the final locker-cleanout which



From the day the first candidates report for spring training, they seek to guide all the personalities that make up a major league team.

symbolizes the end of another season. They're scorched, scorned, and frequently shouted at; they're also held in high regard, as witnessed by the full share accruing them in all World Series melons. With the Yankees last season that was a nine-grand touch.

One of the top executives in the business once announced solemnly, "There are no hours in baseball." He didn't mean a droopy-lidded fan trying to find his way home at 2 a.m. after a foot-dragging night game. He meant the hired help and the demands made on their time. He was thinking, perhaps a mite self-pityingly, of himself. Subconsciously, he unquestionably meant his road secretary and the road secretaries of his fellow moguls.

Lost in history is how they first came to be called road secretaries. A phrase which would convey the idea perhaps of a "house-mother-on-wheels" would be infinitely more appropriate. And now that ball clubs are flying with increasing regularity, there has to be some indication,

too, that ministrations to the ball players' needs and fancied needs will be handled adequately at elevations of from five to 35,000 feet.

What does a big, strapping ball player in the prime need with tender ministrations? Can't he take care of himself? The answer is "yes," of course, but the unique problems of moving a ball club through a spring barnstorming trip, around the circuit, into and out of a World Series, are such as to baffle even an Army general who blithely moved a half-million men half-way across Europe.

What problems? Ever try to get a bed-board for a pitcher with a bad back at midnight when a hotel has just issued its last one in stock? Ever try to placate some screaming newspaperman after some dumbkopf had placed his portable typewriter with the OUTGOING baggage shortly after a team arrived at a hotel? Ever try to keep the corn-fed girls away from the pennant-winning heroes in Kansas City and in shutting off the phones you also shut off EVERYONE'S in the entire party—club officials, radio men, newspapermen, etc.?

Ever try to hold a bus-load of steak-hungry ball players after a night game while a harried wreck of a newspaperman pecks out his story in the press-box eyrie atop the almost-blacked out ball park?

Ever try to convince a fulminating railroad man that no one really is watching to see whether his trains are actually adhering to scheduled 1:30 a.m. departures and not to worry about being late and being penalized by the government? And through it all, the phone is ringing,—it's always the phone—and the boss is demanding angrily to know why so-and-so, one of the newspaper fellows, isn't writing nice stuff about the ball club and did you do anything to get him mad?

If someone ever advertised for a baseball road secretary the ad would take up

very little space, considering the uniqueness of the job. It would run something like this:

MAN, Mature, diplomatic, to make all arrangements for professional baseball club traveling around country; act as financial representative on road. Should have some experience disbursing funds. Sal. \$7-10,000. Hours unusual but opportunity for bonus. Winter vacation only. Baseball playing experience not necessary but knowledge of game helpful. If inclined toward ulcers, forget whole thing.

After that the successful applicant would be able to write a book within a couple of years.

What kind of book? A book both side-splitting and poignant, one revealing what goes on inside a ball team, and inside a ball player's mind during the half-year of being subjected to the almost unbelievable tensions that go to make up a major-league baseball campaign.

Moreover, a road secretary has to be a chameleon kind of a fellow. Not too long ago I remember one who sluffed around in bedroom slippers for two weeks on a Western trip because the team was winning. The players insisted that the slippers were bringing them luck. The next trip around the team had its worst road trip in history. On the flight back, the same road secretary, back to shoes with laces, sat in the airplane within easy reach of the door just in case any of the despondent players got the wrong kind of ideas.

In point of service, and national recognition, No. 1 road secretary in the business is Eddie Brannick of the New York Giants. A couple of seasons ago he was the recipient of a \$25-a-plate dinner at the Waldorf-Astoria, honoring him for his half-century of unbroken association with

(Continued on page 51)

ILLUSTRATED BY WILLIAM VON RIEGEN



Ever try to hold a bus-load of players after a night game while a newspaperman pecks out his story in the press box?

*At Christmas and every other
time of the year*

ELKS NATIONAL SERVICE COMMISSION ACTIVITIES

*bring warmth and cheer to
our country's defenders*



This scene was shot during one of the "Quiz" programs put on at Jefferson Barracks in St. Louis by the Missouri Elks when the more than \$1,000 worth of merchandise displayed was distributed to the audience, including non-ambulatory patients who could not attend the show.



P.D.D. H. Fancher Phelps, Chairman of the Alabama Elks Hospital Committee, presents to E.R. Melvin L. Dawkins of Montgomery Lodge a handsome plaque, the gift of appreciative VA Hospital patients. The plaque, executed by the patients over a period of months, carries the Elk's emblem in raised copper, and the inscription "To the Alabama Elks Hospital Committee of Montgomery Lodge No. 596 from the Veterans Hospital".



A recent innovation in the veterans entertainment project of the Illinois N.E. District Elks was an Athletic Field Day when patients from Hines Hospital competed with servicemen hospitalized at Downey. The first attempt was such a success that it will be an annual affair. The Elk sponsors donated this plaque won by the Hines veterans and held by their Hospital Manager Harry Pool who accepted the award from State Elks Veterans Service Committee Chairman William A. Lauer.



Photographed when the Rhode Island Elks Assn. presented to the Veterans Hospital in Providence two RCA 400 junior movie projectors were, left to right, Hospital Mgr. Dr. Wm. J. Sullivan, Hospital Service Committee Chairman Dr. Edward C. Morin and D.D. Fred F. Quattromani. The 16 mm. projectors, equipped with sound, cost \$714.



Veterans from the Army's General Hospital at Valley Forge, Pa., enjoyed the "Miss America" Pageant this year as guests of Atlantic City, N. J., Lodge. Welcomed by a committee headed by E.R. Adolph Miller and Chairman Wilbur Schultz, the 14 servicemen received the key to the city from Mayor Joseph Altman, a P.E.R. After luncheon the soldiers visited the Steel Pier, and later dined at the lodge home.

Past Grand Exalted Ruler Charles E. Broughton



On October 31st, Past Grand Exalted Ruler Charles E. Broughton, who for many years was a prominent newspaper publisher in Sheboygan, Wis., passed away at St. Nicholas Hospital, where he had been a patient for eight weeks.

Mr. Broughton was born in Lamartine, Wis., on October 22nd, 1873, and had been a member of the Order since 1903, when he was initiated in Fond du Lac Lodge. In 1922 Mr. Broughton demitted to Sheboygan Lodge, where he was elected Exalted Ruler in 1926. From 1931 to 1939, he was Chairman of the lodge's Board of Trustees.

Past Grand Exalted Ruler Broughton was elected President of the Wisconsin State Elks Association in 1929, and at an early date evidenced interest in the rehabilitation of crippled children. For many years, until 1940, he served as Chairman of the Association's Crippled Children's Commission.

Mr. Broughton had been active in the Grand Lodge since 1930, when he was appointed District Deputy. He served on the Grand Lodge Good of the Order Committee in 1931-32; was Grand Esteemed Leading Knight in 1932; Chairman of the Antlers Council, 1939-40; Chairman of the State Associations Committee, 1940-41, and in 1942 was elected to the Board of Grand Trustees, of which he was Chairman when he was elected Grand Exalted Ruler in New York in 1946.

Mr. Broughton had a distinguished career in journalism that began at the age of eleven when he started work as an apprentice printer with the Fond du Lac "Journal." For many years, until his retirement in 1951, he was editor and publisher of the Sheboygan "Press". After his retirement he continued his outstanding career in journalism as

a commentator on Sheboygan's Radio Station WHBL.

Mr. Broughton had long been a leader in civic affairs of his city and state. He founded the Sheboygan Kiddies' Camp which provides summer vacations for under-privileged children. It was due to his leadership that Sheboygan became one of the first cities in Wisconsin to organize a school for physically handicapped children. He was a life member of the Wisconsin Association for the Disabled.

Past Grand Exalted Ruler Broughton organized Sheboygan's first two benefit balls to aid infantile paralysis victims held on President Roosevelt's birthday, and for many years served as Treasurer of the Sheboygan Chapter of the National Foundation for Infantile Paralysis. He was a founder of the Sheboygan YMCA and of that city's Community Fund.

Mr. Broughton's outstanding public service was recognized in 1933 by his appointment as Colonel on the staff of the Governor of Wisconsin, and in 1942 the Salvation Army awarded him its Distinguished Service Medal. He was a member of the Democratic National Committee from Wisconsin in 1926.

Following his term as Grand Exalted Ruler, Mr. Broughton served as a member of the Elks National Service Commission. Later he served as a Trustee of the Elks National Foundation. Early in 1956 Mr. Broughton was appointed to the Elks National Memorial and Publication Commission.

The Elks Magazine, which Mr. Broughton was serving so capably at the time of his passing, joins with his widow and the entire membership of Elkdom in sharing the loss of one of the best-loved and most able leaders in the history of the Order.



With the Grand Exalted Ruler on the occasion of the 21st annual Upstate Conference held at Oneida, N. Y., Lodge on September 23rd, were from left: Past Grand Exalted Ruler James T. Hallinan (Grand Exalted Ruler Bohn) State Assn. Pres. Francis P. Hart and Chairman Board of Grand Trustees Ronald J. Dunn.

Lodge Visits of FRED L. BOHN

GETTYSBURG, PA.: Grand Exalted Ruler Bohn was at Gettysburg, Pa., Lodge on September 13th to attend the Golden Anniversary banquet and approximately 350 members attended the dinner. The highlight of the program was the presentation of 50-year pins to two charter members: J. A. Holtzworth and William Grenoble. Presentation of the pins was made by Past Grand Exalted Ruler Howard R. Davis and Exalted Ruler C. David McCullough. Youth Activities Committee member H. Earl Pitzer was Master of Ceremonies. State Pres. A. Lewis Heisey spoke at the dinner and congratulated the Gettysburg Lodge for its splendid achievements.

ONEIDA, N. Y.: The 21st annual Upstate Conference of the New York State Elks Assn., held in Oneida on September 22, was an occasion for a visit by the Grand Exalted Ruler. Over 50 upstate lodges were represented at the event. Among the distinguished guests present for the occasion were Past Grand Exalted Ruler James T. Hallinan, Chairman Board of Grand Trustees Ronald J. Dunn, Grand Lodge Auditing Committee member James A. Gunn, State Pres. Francis P. Hart, State Youth Activities Chairman James Hanlon, Past State Pres. Franklin J. Fitzpatrick and James E. Doyle, who is chairman of the scholarship program in the Central District.

PONTIAC, ILL.: Over 300 persons were present on July 14th at Pontiac, Ill., Lodge when Grand Exalted Ruler Fred L. Bohn made his first official lodge visit. Special guests who spoke at the banquet were Past Grand Exalted Ruler Henry C. Warner and State Pres. George F. Thornton. PDD William Wolf was Master of Ceremonies and he was introduced by Exalted Ruler Richard A. Thompson. Other guests included Grand Secretary Lee A. Donaldson, Frank Vessel, Comp-

troller in the G. S.'s office, State Secretary Albert Arnold, State Treasurer Roy W. Smith, and Past State Presidents Denham Harney, Charles W. Clabaugh and Donald Patten. District Deputy Leslie Snyder and Past District Deputy Kenneth B. Clothier were on hand for the occasion as were four 50-year members of Pontiac Lodge, Dr. J. D. Scouler and J. G. Whitson, charter members, Delbert R. Capes and Harrison Smith for this outstanding occasion.



Left: Present with Grand Exalted Ruler Bohn when he was at Easton, Md., Lodge to attend the Dela., Md. and D. C. State Association Convention, Aug. 23-26, were rear row, left to right: Past Pres. Paul Shutt (Mr. Bohn) Pres. Claude S. Martin and Past Grand Exalted Ruler Dr. Robert South Barrett. Second row from left: Elmo Hackett, Andrew Jarboe, DD Lloyd B. Pahlman, DD Charles L. Mobley, Alton Jacob and James Quick. First row: State Association officials, Joseph G. Motyka, R. Edward Dove, Palmer and Robert Zittinger.



Above: Meeting the Grand Exalted Ruler at the Butte, Mont., airport on October 15th were, front row from left: State Trustee Leroy Seymour, Publicity Chairman George Wellcome, PER Carroll Fabian, Karl Deshler, Fred Honeychurch, Jr., and William Stanaway. Rear row: Past Grand Esteemed Lecturing Knight F. R. Venable, State Pres. LeRoy P. Schmid, Past Grand Exalted Ruler Sam Stern (Mr. Bohn) Exalted Ruler James Carden and Past Exalted Rulers Clyde Carpino, Newell Evans and John Cunningham. At a dinner meeting and initiation honoring the Grand Exalted Ruler, 15 of the 24 Montana lodges were represented and Past Exalted Ruler James T. Finlen Jr., was chairman in charge of arrangements for the Grand Exalted Ruler's visit.



Above: Welcoming Grand Exalted Ruler Fred L. Bohn to Brattleboro, Vt., Lodge on October 2nd, were front row from left: State Pres. Charles W. Landry, Exalted Ruler Robert J. Cross (Mr. Bohn) District Deputy Francis P. Ratti and Past Grand Exalted Ruler John F. Malley. Rear row: Henry Ryan, ER of Bennington; Grand Treasurer Edward A. Spry; Elmo Cloutier, ER of Bellows Falls; Bernol Dow, ER of Windsor; PER James C. Irish; Ross Fenno, ER of Montpelier; George Earle, ER of Springfield, Past District Deputies Asa Bloomer, Edward Giovangelli and Dominick Flory and State Trustee Ralph W. Michelman.

Right: With the Grand Exalted Ruler when he visited Newark, Ohio, September 4th, were from left: State Pres. Herschel Deal (Grand Exalted Ruler Bohn) District Deputy James Mills and Exalted Ruler Louis Muenz.





On September 15th Grand Exalted Ruler Bohn visited Gatlinburg, Tenn., Lodge, and photographed with him at his right were Exalted Ruler Robert Miller and at left State Pres. Ed Seagraves.



The first official visit of Grand Exalted Ruler Fred L. Bohn was to Pontiac, Ill., Lodge on July 14th for the 50th Anniversary Celebration. Photographed on the Elks Country Club lawn were, front row, left: Raymond Mathieson, Myron Hiens (Grand Exalted Ruler Bohn) Past Grand Exalted Ruler Henry C. Warner, Arthur Welsh, Francis Smith and Emil Hanson. Second row: ER Richard Thompson, PDD William S. Wolf, Merle Shoop, William Durham, Farley Sparks and Martin Wald.



While at his home city of Zanesville, Ohio, on September 7th, the Grand Exalted Ruler made a tape recording with, from left: William Watson, National Sec'y. of Fraternal Order of Eagles; (Mr. Bohn); T. Vincent McIntire, Pres. of Toastmasters International, and William Wetherald, financial advisor of F.O. Eagles.



Laconia, N. H., Lodge honored the Grand Exalted Ruler with a luncheon on October 4th and present were from left: PER Mayor Bernard L. Boutin, ER Wendell L. Shoza, Grand Treasurer Edward A. Spry, (Mr. Bohn) District Deputy Henry J. Salvail and Past Grand Exalted Ruler John F. Malley.



During his visit to Denver, Colo., Lodge on September 20th, Grand Exalted Ruler Fred L. Bohn went to the Colorado State Capitol for a call on Governor Edwin C. Johnson, who has been a member of Craig Lodge for 40 years. Mr. Bohn is seated at right beside Governor Johnson, and standing left to right are: member Grand Lodge Committee on Judiciary Jacob L. Sherman, District Deputy Albert H. Heller, Exalted Ruler Kirk V. Cammack, State Secretary Frank Buskirk and State Pres. Donald Johnson.



With the Grand Exalted Ruler at Belfast, Me., Lodge the evening of Oct. 6 when the lodge was instituted were front row, from left: Past Grand Exalted Ruler E. Mark Sullivan (Mr. Bohn), Exalted Ruler Walter Omar and Past Grand Exalted Ruler John F. Malley. Rear row: Past Grand Esteemed Lecturing Knight Daniel Crowley, State Pres. Joseph J. Cummings, member Grand Lodge Youth Activities Committee Brian M. Jewett, District Deputy Carl M. Stilphen and Grand Treasurer Edward A. Spry.



Salamanca, N. Y., Lodge held its 50th Anniversary Dinner on September 26th, and present with the Grand Exalted Ruler were, from left, front row: C. A. Crouch, Pres. N. Y. Elks State Assn. Francis P. Hart (Grand Exalted Ruler Bohn) Past State Pres. Franklin J. Fitzpatrick and Exalted Ruler H. A. Campbell. Rear row, left to right: D. J. Fitzgerald, John Crouch, Charles Peterson, John McConnell, Allan Swanson, T. D. Brennan and Mort Cohn.



On Sept. 13th the Grand Exalted Ruler was at Gettysburg, Pa., Lodge to attend a 50th Anniversary banquet at which J. A. Holtzworth of Gettysburg Lodge, seated left, and William Grenoble of Rehoboth Beach, Del., Lodge, right, were presented 50-year pins. Center, first row are Past Grand Exalted Ruler Howard R. Davis and M. Bohn. Standing from left: Member Youth Activities Com. H. Earl Pitzer, State Pres. A. Lewis Heisey, ER C. David McCullough, DD William K. Rice and C. C. Merrill.

ELKS LODGE ACCOMMODATIONS

WE HAVE HAD so many requests for an Elks Lodge accommodation list that we plan to publish portions of the list from time to time in our travel columns. This eighth installment will be followed, as space permits, in later issues, until the entire list is published.

Following the complete publication, we plan to incorporate all this information in a pocket-sized booklet for our traveling readers. If your lodge is not listed, it means we have received no answer to our request for information sent out last May.

ILLINOIS (Continued from October)

EAST ST. LOUIS. Bar
EFFINGHAM. Cocktail Lounge
ELGIN. Lunch & Dinner, Cocktail Lounge
ELMHURST. Cocktail Lounge
EVANSTON. Bar
FAIRFIELD. Lunch & Dinner (Except Thurs. & Sun.) Bar
FLORA. Cocktail Lounge
FREEPORT. Dinner; Cocktail Lounge
GALENA. Bar
GALESBURG. Lunch & Dinner; Cocktail Lounge
GRANITE CITY. Lunch; Cocktail Lounge
HARRISBURG. Bar
HARVEY. Rooms (Elks only); Cocktail Lounge
HIGHLAND PARK. Cocktail Lounge
JACKSONVILLE. Lunch; Cocktail Lounge
JOLIET. Lunch; Bar
KANKAKEE. Lunch; Cocktail Lounge
KEWANEE. Lunch & Dinner; Bar
LA SALLE. Rooms (Elks, Wives & Guests); Dinner (Fri. & Sat. only); Cocktail Lounge
LAWRENCEVILLE. Dinner
LINCOLN. Lunch (Country Club—Golf. Bar)
LITCHFIELD. Rooms (Elks & Male Guests). Breakfast-Lunch-Dinner; Bar
MACOMB. Cocktail Lounge
MARION. Cocktail Lounge
MATTOON. Dinner; Bar
McLEANSBORO. Bar
MENDOTA. Lunch & Dinner; Cocktail Lounge
METROPOLIS. Bar
MOLINE. Lunch & Dinner; Cocktail Lounge
MONMOUTH. Lunch & Dinner; Cocktail Lounge
MT. VERNON. Lunch & Dinner; Cocktail Lounge
MURPHYSBORO. Bar
OAK PARK. Rooms (Elks only); Cocktail Lounge
OLNEY. Dinner; Cocktail Lounge
OTTAWA. Lunch & Dinner; Cocktail Lounge
PARIS. Lunch & Dinner; Bar (Country Club—9 Hole Golf Course)
PEKIN. Bar
PEORIA. Lunch & Dinner (Sat. only); Bar
PONTIAC. Dinner (Sat. only); Cocktail Lounge; (Country Club—9 Hole Golf Course)
PRINCETON. Lunch & Dinner; Bar
QUINCY. Lunch; Bar
ROBINSON. Lunch (Elks) & Dinner (Elks, Guests); Cocktail Lounge
ROCKFORD. Lunch; Cocktail Lounge
ROCK ISLAND. Lunch & Dinner (Sat. only); Rooms (Elks only); Bar
SALEM. Lunch & Dinner; Bar
SPRINGFIELD. Rooms (Elks & Male Guests); Breakfast-Lunch-Dinner; Cocktail Lounge
(Illinois to be continued)

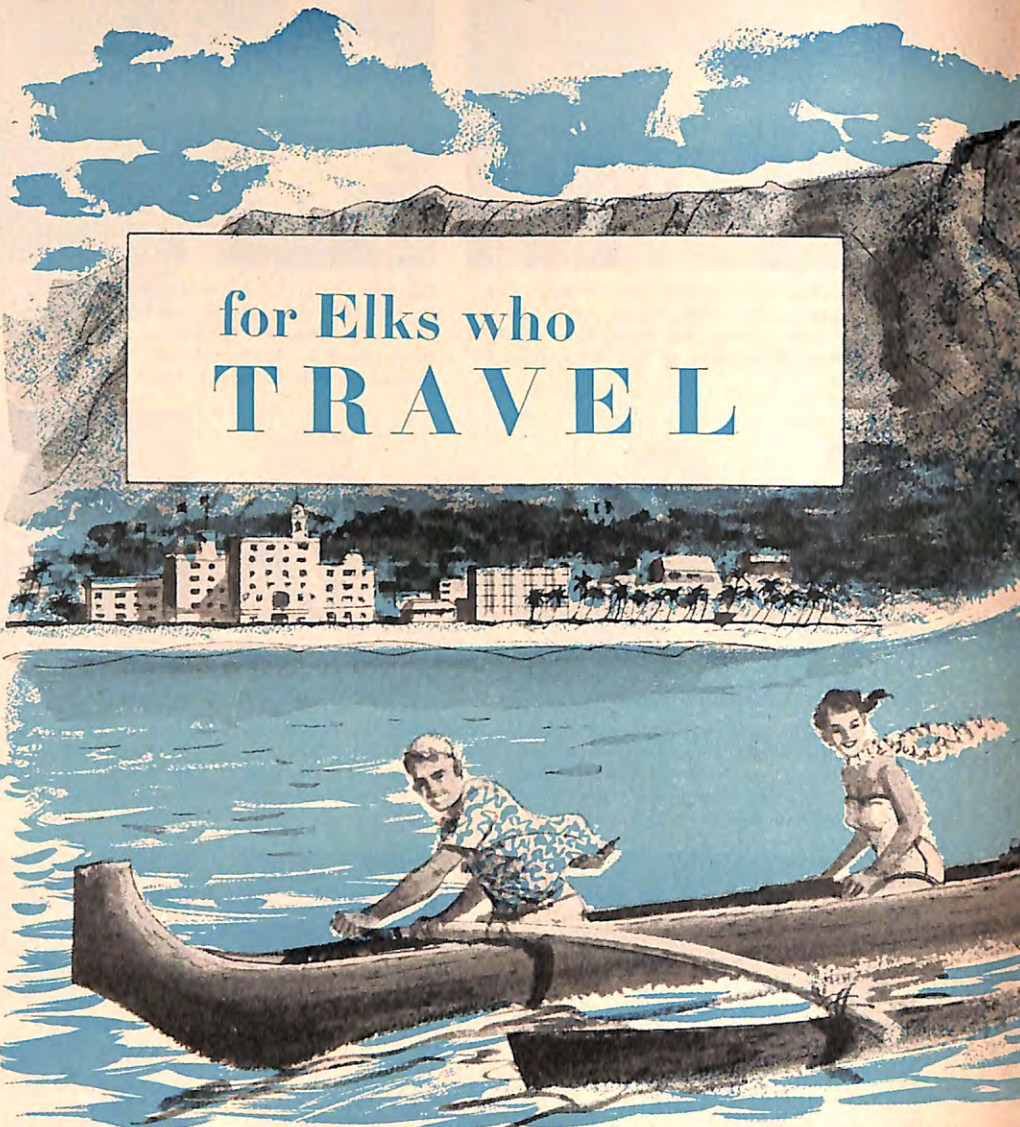

for Elks who
TRAVEL

Hawaii's Waikiki Beach is becoming one of the most populated strips of sand in the world.

BY HORACE SUTTON

IT IS GOING to be touch and go out in Hawaii whether they run out of beach-front before they run out of steel and bricks. Things haven't approached the plight of Miami Beach as yet where you have to breach the Great Wall of hotel-dom in order to see the sea, but things are heading that way. Only ten years ago Hawaii counted 15,000 visitors. It was for travelers a lean year, a year when the DC-4 was just about the jazziest plane in the air and pressurization was a coming improvement.

Well, last year Hawaii racked up well over 100,000 visitors and nobody knows how far over *this* year's figures will be. It is difficult to say which comes first, the people or the hotels, but inns seem to have sprouted everywhere since I visited here last in the late spring of 1954. For one thing, Mr. Henry J. Kaiser had descended on the unsuspecting atoll, swooping up

the old Niunalu hotel as he went. When he got through with it, it wasn't the Niunalu anymore, it was the Hawaiian Village, complete with 220 rooms and 100 more on the way. The roof tops have been woven of thatch in the genuine manner by Samoans. They also got out of hand and put a thatched roof on a station wagon which was henceforth known as the Little Grass Shaxi. Oh, they're cards, out here, I tell you.

Now these thatched roofed houses where the guests sleep are scattered all around a rainforest all Kaiser-manufactured and the place is creeping with bananas, ferns and some carved Polynesian gods that would scare the eyeglasses off a visiting librarian. The only trouble with Kaiser's place was that it was located just shy of Waikiki. Or to put it another way, Waikiki ran out before it got to Kaiser. So Henry J. just pumped himself up a beach



ILLUSTRATED BY TOM HILL

and it runs now for some 2,000 feet. All it cost was a quarter of a million.

If Kaiser is not exactly on Waikiki, a number of places are at least near enough to it to benefit from the magic of the name. Now on hand are the Waikiki Hotel Apartments, the Waikikian, the Waikiki Plaza, Waikiki Studio Apartments, Waikiki Surf, Waikiki Terrace and the Corals in Waikiki. These places vary anywhere from \$30 a week with kitchens up to the fancy Waikikian which is brand new and features a semi-collapsed roof known as a hyperbolic parabola.

The Matson people, which maintain the magnificent Royal Hawaiian, the Moana and the Surftrider, have also added, since my last visit, the Princess Kaiulani, just a block off the beach. It has 288 rooms, an arcade with shops, and that indispensable unit in resort hotels nowadays (no matter how near the sea) a pool. Also new to me was the aforementioned Waikiki Biltmore with 200 rooms and a night-club in the penthouse as well.

I must say that the beach at Waikiki, whether one lives on it or merely comes to it each day, is one of the most active strips of sand in the world. People don't just sit and sun. Nor is the activity solely

the hucksters selling some absolutely necessary accoutrement, the way things are in Acapulco. Here everybody is up surfboard riding, or at least learning how. Or they are off on rides in an outrigger canoe which come zipping in with the waves, the surfboard people skimming just alongside. Or they are way out in the blue on catamaran rides cutting through the blue Pacific. And all the while, at the far end of the crescent of pleasure that is Waikiki, Diamond Head stands guard, a massive extinct volcano rising proudly like a monumental lion as it faces the sea.

At night the lei stringers light their lanterns at their curbside stands and make garlands of orchids, plumeria and white pikake. The lights twinkle on in the sidewalk restaurants that have sprung up on Kalakaua Avenue and men in white and ladies with flowers tucked in their hair dine by flickering candles. Don the Beachcombers is a maze of thatched huts, Polynesian Tikis, oriental bridges, sylvan pools, and tropical foliage—an entrancing place for dinner. The new Canlis's is an enchanting spot, one of the world's most attractive restaurants with a decor that is both modern and yet tropical Hawaiian.

(Continued on page 42)

RETIRE IN MEXICO ON \$150 A MONTH

or less in a resort area, 365 days of sun a year, dry temp. 65-80°. Or maintain lux. villa, servants, ALL expenses \$200-250 a mo. Am.-Eng. colony on lake 60 mi. long. 30 min. to city of 1/2 million, medical center. Schools, arts, sports. Few hours by air. Train, bus, PAVED roads all the way. Full-time servants, maids, cooks, \$6 to \$15 a mo., filet mignon 35c lb., coffee 40c, gas 15c gal. Gin, rum, brandy 65c-85c fth., whiskey \$1.50 qt. Houses \$10 mo. up. No fog, smog, confusion, jitters. Serene living among world's most considerate people. For EXACTLY how Americans are living on \$50—\$90—\$150—\$250 a mo., Airmail \$2.00 for COMPLETE current information, photos, prices, roads, hotels, hunting, fishing, vacationing and living conditions from Am. viewpoint (Pers. Chk. OK) to Bob Thayer, Box 12A, Aijic, Lake Chapala, Jal., Mexico.

HOTEL PICCADILLY

TV and Air-Conditioning Available
GARAGE
Banquet Facilities 50 to 400
James P. Somerville, Resident Mgr.
Fred. J. McBride, Managing Director

Singles \$5.50
Double \$8.50

227 West 45th Street, New York 36 • Circle 6-6600

You'll Enjoy Your Stay in WILLIAMSPORT, PA.

Williamsport, Pa., Lodge No. 173 welcomes traveling Elks. Our hotel facilities are stag only with clean, livable rooms—20 of them with connecting showers for transient guests. Rates—\$2.50 and \$3.00. Well equipped grill with an excellent cuisine. Dining room for public use.

Yes, you'll enjoy your stay in Williamsport if you stay at the Elks.



You'll Remember LAS VEGAS

When you stop at Las Vegas, New Mexico B.P.O. Elks No. 408 you'll find true club life and a friendly greeting. More like a home than a hotel. Eight rooms available most of the time—and if price concerns you, forget it—the rates are very reasonable. Hotel rooms restricted to Elks only. Sorry, no facilities for their ladies. Bar and it serves snack meals. When in this locality give our good club a try. We think you'll like it.

FOR Particular ELKS

ABERDEEN LODGE IS THEIR CHOICE

Here are 32 comfortable rooms, 17 with baths including 3 suites and the rates are only what you'd pay in any public hotel where you *wouldn't* get full club accommodations. Rooms \$2.50 to \$3.50, monthly \$25 to \$45. Limited to Elks only.

Lunch from 11:30 to 1:30. Recreation rooms for cards and billiards. Fine cocktail lounge.

ABERDEEN B. P. O. ELKS No. 593
Broadway and Wishkah Aberdeen, Wash.

News of the Lodges



Tacoma, Wash., Lodge's 52-man Grand Exalted Ruler's Class, with Special Deputy Edwin J. Alexander, eighth from left, foreground, P.D.D. C. J. Weller and E.R. Norbert E. Grove and his officers.

Activities Planned by Wisconsin Elks

The largest delegation ever to attend a Fall Conference of the Wisconsin Elks Assn. attended this year's event at Green Bay, with Pres. Arno J. Miller presiding.

Decisions on various program dates included a Midwinter Conference to be held Feb. 16-17 at Milwaukee; the 1957 Annual Convention at Fond du Lac June 6-7-8, with the Elks' State Golf Tourney to be held at South Hills Country Club there at the same time. The finals of the Elks Constitution Contest, a student essay competition, will take place at Neenah-Menasha in April, with the Annual Bowling Tournament in Milwaukee from Feb. 2nd to April 7th, entries closing Jan. 4th.

Past Pres. Alfred LaFrance was named Chairman of a Committee to sponsor new lodges and reinstate inactive ones, and Dr. M. J. Junion, General Chairman for

the Conference, received a plaque from Grand Lodge Activities Coordinator Bert A. Thompson, in recognition of Dr. Junion's outstanding service as three-year Chairman for the Assn.'s Youth Activities which won first place in the Nation for the past year.

New Mexico Cerebral Palsy Project Expands

The addition of a full-time director for its Cerebral Palsy Program has marked the eighth anniversary of the New Mexico Elks Assn.'s special project. Albert Sparks, former mobile unit therapist for the program is the new director. Another added feature is the brace shop in the Bernalillo County Indian Hospital in Albuquerque where brace prescriptions may be filled for anyone needing the facility.

The project, to which the Elks of the State voted a \$31,620 budget this year, began with a mobile unit manned by a



Well-known Washington Correspondent Tom Wrigley, left, joined 635 guests at the annual outing of his fellow Elks of Elmira, N. Y., this year. With him are Exalted Ruler Owen P. McCarthy and Outing Chairman Richard Tillinghast.

therapist and equipped for visits to afflicted children in their homes. Today, over 200 cerebral-palsied youngsters are being aided and the unit replaced, both units having traveled over 180,000 miles on their tours of mercy. On a state-wide level over \$130,000 has been made available since the program began, and local lodge efforts have brought the total to about \$250,000.

Flora, Ill., Elks Sponsor Junior Gridiron Group

Last year E.R. Clair Christensen of Flora Lodge No. 1659 organized Illinois' first League of Little Football Players. A total of 85 boys, from nine to 12 years old, were equipped by the Elks at a cost of \$700. The movement gained momentum through the efforts of Elk Bill Middleton who supervised the project, with the result that members of the American Legion, the Veterans of Foreign Wars and the Flora Record Publishing Co. jointly took on the sponsorship of 85 13- and 14-year-old boys.

Twenty members of these organizations give from three to five evenings a week to coach the players and officiate at their weekly games which, incidentally, have large and enthusiastic followings. These



E.R. Marvin B. Martinique of Passaic, N. J., Lodge, presents a charter to Richard Mizdal, President of the Junior Elks of the Passaic Boys' Club, as other youthful officers of the organization look on. The group, consisting of 25 boys between the ages of 9 and 16, has as its goal "the building of physically fit, self-reliant, tolerant and all-around good citizens, of good character, who have a belief in the American system of good government and in the Elk ideal of helping others".



Photographed when Rock Hill, S. C., Lodge played host to Elk scholarship winners and faculty members from Winthrop College were, left to right, Dr. Henry Sims, College President; D.D. H. P. Porter; Past State Pres. M. S. Bell; Miss Maxine Carter; E.R. Sam J. Todd, Jr.; Miss Nar Warren Taylor, Winthrop Dean; Miss Gloria Hester, two-time State winner; State winners Miss Kathleen Crain and Miss Joyce Gregory, and Miss Betty Jean Pritchard, \$500 Elks National Foundation award winner.

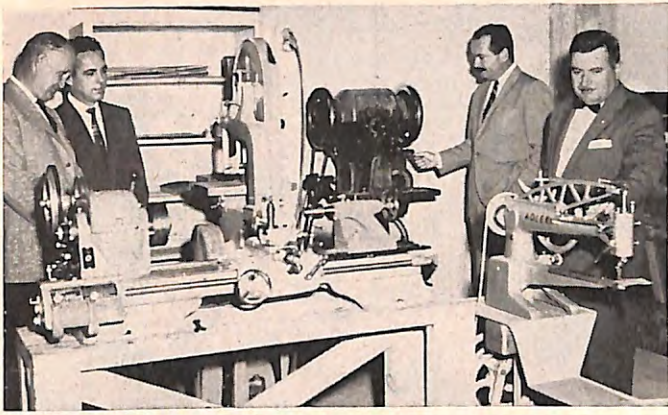

The New Mexico Elks Assn.'s Cerebral Palsy Program has added another valuable service to the existing program, with the installation of a non-profit brace shop in the Bernalillo County Indian Hospital in Albuquerque. The shop will construct and repair all types of orthopedic appliances for crippled children and adults of the State when prescribed by the patient's physician. Inspecting the new facility are, left to right, Special Projects Chairman Ashley Thompson, the Assn.'s CP Committee Chairman Don Childress, Hospital Adm. J. E. Jenkins and State Pres. Fred H. Dilley, Jr.



The Elks of Bronx, N. Y., did their part in promoting registration for the November elections when they distributed several thousand "Register-Vote" strip posters for motor cars. Deputy Traffic Commissioner David R. Post, Chairman of the lodge's Americanization Committee, was pictured as he put a strip in place with the help of Mrs. Helen M. Wacker, President of the Bronx Soroptimist Club. Looking on, left to right, are Exalted Ruler Gene Amabile, J. F. Callo, Alan C. Hart, Matty Miller, the Drive's Publicity Chairman, and Donald Darcy, the Bronx Rotary Club Pres.



Tampa, Fla., Lodge recently dedicated a new school building which it erected at a cost of \$8,500 for the use of the Gulf Coast School of Oral Education. The Elks are sponsoring the institution where deaf children will learn to talk. Grand Trustee W. A. Wall was the principal speaker at the dedication program, at which State Pres. George Carver also made an address. Photographed on this occasion were, left to right, P.E.R. J. P. Williams, Mr. Carver, Pres. K. R. Laminger of the Gulf Coast School of Oral Education, Mr. Wall, E.R. Guy C. Thomas, Ed Slavin, who directed the school's construction, and Social and Community Welfare Committee Chairman R. F. Powers.



Since 1942 the Kentucky Elks Association has presented to the State Department of Health seven mobile X-ray units at a cost of about \$200,000. Four are now operating; one is on a stand-by basis and two, having outlived their usefulness, have been abandoned. Not long ago, the two millionth X-ray was taken by Elk Lawrence Hill, unit technician, at special ceremonies in Lexington. The "patient" was Kentucky's Governor, A. B. "Happy" Chandler, a Frankfort Elk. Photographed on that occasion were, left to right, Past State Presidents S. H. Grove, and Dr. John B. Floyd, Governor Chandler, former Grand Trustee Arnold Westermann, and Dr. Russell Teague, State Medical Director.

exciting contests are played on the local high school football field, with the young girls of the community doing their part as cheer-leaders.

In P.E.R. Mayor Norman Bryden's column in the Flora newspaper, he gave high praise to this very worthwhile effort, the first in his State.

Kinston, N. C., Elks' Home Dedicated

Kinston Lodge No. 740 dedicated its handsome \$100,000 home at ceremonies attended by Elks from all over the State. Past Grand Exalted Ruler John L. Walker was the guest of honor on this occasion,

together with Grand Est. Loyal Knight Thad Eure, Secy. of the State of N. C., State Pres. W. R. Pritchett, Jr., and P.D.D. F. T. Dupree, Jr., of No. Car., and Past Pres. R. M. Ward of the Va. Elks Assn.

E.R. F. A. Leggett opened the program

for which P.D.D. George T. Skinner was master of ceremonies. Mr. Eure presented a special P.E.R.'s pin to Lloyd B. Humphrey, as a token of appreciation for his leadership in planning and construction of the building during his administration.

Pictured at the dedication of the handsome entrance marker they provided for the Keystone Area Council Boy Scouts are Harrisburg, Pa., Elks P.E.R.'s Albert J. Filippelli and Wm. W. Lipsitt, principal speaker, D.D. Wm. K. Rice, Est. Loyal Knight Arthur E. Poorman, Inner Guard Russell Wampler, Secy. A. R. Kerson, J. L. McWilliams, Est. Lect. Knight F. E. Moeslein, Committee Co-Chairman, E.R. John Hill, Chaplain E. J. Huggins, and Scout Committee Co-Chairman M. J. Sachs.



LODGE NOTES

Midwest City, Okla., Lodge is making history with its many large initiations. A class of 101 men became affiliated as a tribute to the Grand Exalted Ruler at ceremonies attended by over 200 Elks, among them Past Grand Exalted Ruler Earl E. James, D.D. Roy Gonders and Past State Pres. Earl McCroskey. A month earlier, 51 members were added to the roster, and 113 applications are in the process of study at this writing.

About 150 Elks and their guests enjoyed a \$15-a-plate Booster Dinner at the home of West Haven, Conn., Lodge recently. A success from every standpoint, the novel and entertaining affair was the brain-child of Charter Member Harry Hart and will no doubt be repeated very soon.

Baseball is as popular in Alaska as it is in the States. The Antlers team representing Anchorage Lodge as League Champion traveled to Juneau in August to participate in the American Legion Junior Baseball Tournament there. While they took the first game, bad weather for the second contest found the Anchorage nine lagging behind their opponents. The rain stopped for the third game, but the visitors were unable to rally for another win. However, the entire trip was a successful one from an over-all standpoint, and the Antlers carried home a handsome plaque as their award as second-place winners.

E.R. R. J. Kitsteiner reports with pride that his five-year-old North Miami, Fla., Lodge leads the State in membership growth for the year. It also had the largest percentage growth for lodges of less than 500 Elks, with 91.77. Of the net gain of 718 members for the South District, North Miami added 424; it also headed the transfer list with 73 dimits.

When D.D. A. H. Eckert of Pennsylvania North paid his official visit to Kane Lodge, E.R. James E. McKenna and his officers initiated a class of 12 candidates during the lodge session.

The passing of several devoted long-time members has just been brought to our attention. Fremont, Ohio, Lodge mourns Wm. A. Adams, an Elk for more than half a century; Edward H. Huggins of Marion, Ohio, Lodge passed away after 65 years' service to the Order, and Palatka, Fla., Lodge recently suffered the loss of Edward A. Perry Ross, one of its Charter Members.

Pottsville, Pa., Lodge's entry in the parade which climaxed that community's Sesqui-Centennial celebration carries Queen Jane Maurer and her court, Peggy Carlin, Shirley Rose, Karen Schlitzer, Barbara Reeves and Sandra Clayton. The girls, all daughters of Elks, were selected in a contest sponsored by the lodge's Youth Activities Committee.



Lodge Instituted at Belfast, Maine

Another link in the chain of Elkdom was forged when Belfast Lodge No. 2012 was instituted, with D.D. Carl M. Stilphen in charge. Assisting in this ceremony were State Assn. Pres. Joseph J. Cumming, P.D.D. Alfred L. Bolduc, and Brian M. Jewett of the Grand Lodge Youth Activities Committee who was the principal speaker.

Over 125 persons gathered on this occasion, when 50 Charter Members were initiated by E.R. Kenneth LeGage and his officers from Rockland Lodge which sponsored this new branch of the Order whose first Exalted Ruler is Walter Omar.

Rochester, Minn., Elks' Hold Golf Tourney

In spite of bad weather, 31 golfers from Austin, Minneapolis, St. Paul, Winona and Rochester participated in the Annual Golf Tournament sponsored by Rochester Lodge No. 1091.

The event, held at the Soldiers' Field Course, found L. D. Stoffer of the host lodge as winner in the Championship

Flight. While Bill Gates of Winona was low man for the first flight, a trio of Rochester Elks took the second, third and fourth rounds, in this order—Dave Shearer, Ralph Graen and Wendell Erbes.

Bridgeport, Conn., Elk Edward Daly Honored

The lodge rooms of Bridgeport Lodge No. 36 were filled to capacity by friends of P.E.R. Edward J. Daly at the testimonial dinner held in his honor. Initiated 52 years ago, Mr. Daly has held a Life Membership since 1929, and has served his lodge as Secretary since 1935. A former Vice-President of the Conn. Elks Assn., Mr. Daly is also the oldest living P.E.R. of No. 36.

P.E.R. Wm. K. Mulvihill served as Toastmaster introducing Past Grand Exalted Ruler James R. Nicholson, Chairman Arthur J. Roy of the Grand Lodge Committee on Lodge Activities, D.D. Warren G. Harold, Mayor Jasper McLevy and Supt. of Welfare John J. Galla. Tokens of esteem were presented to the guest of honor by E.R. E. F. Reagan, P.E.R. J. L. Shalvoy and Henry Greenstein.

(Lodge News continued on page 35)



The Mass. West Central Dist. Ritualistic Champions from Worcester are, left to right foreground, Inner Guard Frank DeCaro, Chaplain Gerald Belanger, Esq. A. J. Mattie; standing, Est. Loyal Knight C. A. Grant, Lead. Knight J. F. McGreevy, E.R. J. A. Aspero and Lect. Knight G. P. Daniels.



Pictured with E.R. Frederick Bold, Jr., a Colonel in the U.S. Army Reserve, during the 45th Anniversary celebration of Richmond, Calif., Lodge were, left to right, Charter Members Dr. E. W. O'Brien, a 53-year Elk, and 46-year members P.E.R.'s Dr. Clark L. Abbott, John A. Bell and Jack W. Mellbourne.

OLD TIMERS IN ELKDOM

ONCE AGAIN we have the opportunity to give recognition to some of the Order's members whose years of service qualify them as "Old Timers in Elkdom".

Modesto, Calif., Lodge boasts three veteran Elks, all Honorary Life Members—Chas. D. Swan, who was its first E.R. will be 91 years old next month; he has been an Elk 55 years. Walter T. Scoon, a 45-year-member, is 78 years old and was the lodge's third E.R.; 80-year-old Harold B. Holman has rarely missed a meeting in all his 55 years' affiliation.

One of Beaver Falls, Pa., Lodge's best known and most respected members is 80-year-old Harry B. Chandley. An Elk since 1902 when he joined Apollo, Pa., Lodge, Mr. Chandley served Beaver Falls Elkdom as E.R. in 1912. Since 1913 he has been its Secretary. In 1954 he received a citation from Grand Exalted Ruler Wm. J. Jernick in recognition of his outstanding service.

Newark, N. J., Lodge, has an active and devoted member in Ernest F. Wilms who joined the Order in October, 1906, and a half-century of service to Monmouth, Ill., Lodge is behind Senior P.E.R. James W. Scott, a record he shares with P.E.R. J. M. Evey, Fred B. Pattee and J. A. Tubbs.

Soon to celebrate his 70th birthday, Louis D. Felsheim has been a member of Coos Bay, Ore., Lodge for 36 years, and

82-year-old Moulton V. Kleckner who was initiated into Allentown, Pa., Lodge 53 years ago, was doorman at his lodge home until very recently.

Edward P. May is about to observe his 50th year with New York, N. Y., Lodge of which he has been an Honorary Life Member since 1944. Two years ago, when he was 80 years old, Mr. May retired after 51 years with New York's Sewer Dept. He made the first comprehensive Manhattan sewer survey in 1903, and no doubt knows more about that Borough's 560-mile underground system than any other living person. For 40 years he has testified on the subject in the higher courts, and his evidence has always held. When he retired he was guest of honor at a dinner attended by 200 persons, including many civic leaders.

Horace Abbaticchio has been an Ellwood City, Pa., Elk for 55 years. At 81, he is a two-year member of the famous Three Quarter Century Soft Ball Club of St. Petersburg, Fla. Marysville, Calif., Lodge is very proud of Walter E. Langdon. Born 81 years ago, Mr. Langdon has served his lodge as Secy. for 49 consecutive terms.

Another long-time member is George Hackett. Initiated into Pittsburgh, Pa., Lodge 51 years ago, he helped organize Kent, Ohio, Lodge in 1919 and was its second E.R. He is now 81 years old.

*A tribute to a few
of Elkdom's
most steadfast
and valued
veteran members*



CHAS. D. SWAN



WALTER T. SCOON
Modesto, California



HAROLD B. HOLMAN



HARRY B. CHANDLEY
Beaver Falls, Pa.



ERNEST F. WILMS
Newark, N. J.



JAMES W. SCOTT
Monmouth, Ill.



LOUIS D. FELSHIM
Coos Bay, Ore.



MOULTON V. KLECKNER
Allentown, Pa.



EDWARD P. MAY
New York, N. Y.



HORACE ABBATICCHIO
Ellwood City, Pa.

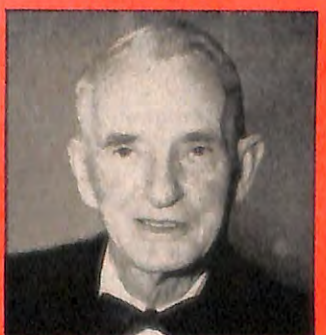

WALTER E. LANGDON
Marysville, Calif.

News of the State Associations



Last year, the Elks of California set \$140,000 as their goal for contributions to their Major Project work for the year. That goal was exceeded by \$8,858. High point in the proceedings during the 1956 Convention was reached as the indicator on the huge clock displayed in Civic Auditorium swung toward the goal and hundreds of multi-colored balloons were released over the stage.

MAJOR PROJECT AGAIN TOP CALIFORNIA ELK EFFORT

**Senator Knowland
Addresses Delegates**

U. S. Senator William Knowland, a member of Oakland Lodge, arrived by plane from Washington, D. C., to address the final session of the California Elks Assn. Convention in San Jose. Acclaimed by the delegates, the Senator also served as Honorary Grand Marshal for the magnificent parade which climaxed the three-day conclave.

Pres. Jim B. Nielsen opened the meeting at Civic Auditorium on October 11th, when Grand Exalted Ruler Fred L. Bohn delivered one of his spirited inspirational addresses, following his introduction by Past Grand Exalted Ruler L. A. Lewis. The balance of the morning was devoted to the extensive reports of the eight Vice-Presidents serving under Mr. Nielsen, all of which attested to the fine growth of Elksdom and its activities in California.

The outstanding efforts of this Association in behalf of cerebral palsy victims, which has been its Major Project since 1950, continues unabated. In his report on this program, Chairman C. P. Hebenstreit revealed that during the year \$54,452.33 had been spent in scholarships for therapists, teachers and post-graduates in this endeavor. This sum, plus expendi-

tures for cars and equipment, operational costs and other purchases, brought the past year's total outlay for the Major Project to over \$203,000. Two divisions were added to the mobile unit operation which now includes 17 units, each consisting of a fully equipped station wagon staffed by a competent therapist. Five hundred youngsters were assisted during the year by the therapists who traveled over 300,000 miles on 13,500 house visits.

Through the popular Piggy Bank activity, a total of \$148,858.71 was realized, with Long Beach Elksdom making the largest contribution, the sum of \$15,000,

E.R. Ira Sanger of Canon City, Colo., Lodge presents his State's "Wandering Yacht" to Grand Exalted Ruler Fred L. Bohn during the Colorado Elks Assn. Convention at Loveland. The "Yacht", a tired old metal row-boat, has traveled all over the State during the year promoting inter-lodge visitations, with members of each host lodge expected to take it with them on a group visit to another branch of the Order. It arrived in Canon City on the eve of the State Association Meeting.



and Huntington Park's Elks donating \$12,500 in this manner. On the per capita level Tulare Lodge's \$5.05 was the highest investment in this effort. Mr. Hebenstreit, who is now Chairman of the Grand Lodge Youth Activities Committee, was replaced as Major Project Committee head by Past State Pres. R. Leonard Bush of Inglewood. New members on this Committee are former State Presidents Earl Williams of Oakland and Robert Mohrbaker of Long Beach.

Robert N. Traver, Chairman of the Calif. Elks Veterans Service Committee, stated that \$500,000 in processed leather had been distributed to veterans' hospitals throughout the country, with Montana Elksdom contributing 2,000 hides. Santa Maria Lodge was commended for its outstanding work in collecting material for therapy departments of these hospitals.

Scholarship presentations reached a new high, with a total of \$10,700 awarded by the Elks National Foundation and the State Association, and youth activities in general were on the increase. Sixty-four lodges had awarded prizes totaling nearly \$6,465 on a local level, with Lancaster receiving high commendation for its splendid youth program, as well as for its 100 per cent paid-up membership, a record Watsonville Lodge has also been holding for the past 14 years. Seven lodges were instituted since the last Convention, and a net gain of 5,573 members was reported.

All of this fine work was delineated in an exhaustive report rendered by State Historian Wm. Gibson Jones of San Jose, who also presented to the retiring President a valuable, hand-lettered bound volume containing clippings and photographs on the year's activities.

Sonora Lodge placed first in the Ritualistic Contest, with San Fernando in second place and El Centro, third. Inglewood's Drill Team was tops in Class A, while Class B honors went to Huntington Park. The billiard players of San Jose Elksdom won that competition, and its four-man golf team captured the title, with Stockton in second place. A one-point lead over Long Beach gave the Pistol Shot cham-

(Continued on page 41)



FOUND



only in a bottle of Seagram's 7 Crown
 the perfection of American
 whiskey at its finest!

Say **Seagram's** and be **Sure**

SEAGRAM-DISTILLERS COMPANY, NEW YORK CITY. BLENDED WHISKEY, 86.8 PROOF, 65% GRAIN NEUTRAL SPIRITS.



IVES MEAT-LIFTERS

the perfect practical gift for the Gourmet!

For any occasion, give a pair of Ives Meat-Lifters. Your thoughtfulness for safety in handling large roasts, hams, steaks, and fowl the easy, convenient way, will be doubly appreciated. No spills—no painful burns—no loss of tasty juices. Features stainless steel tines; natural wood, heat-proof handles. Approx. 12 1/2" long; overall tine spread 6 1/2". Mailed in self-storage box.

Send check or money order—sorry; no C.O.D.'s. **\$2.75 per pair** plus 25c postage in U.S.A. Money-back guarantee.

IVES NEW PRODUCTS, Inc.
211 Medical Arts Building • Richmond, Indiana

Elks FAMILY



GENUINE CULTURED PEARLS. Here's the one piece of jewelry every woman wants—whatever her taste in dress. We haven't seen the equal of this 17" string at less than twice its modest price. Graduated pearls, sterling silver filagree clasp. \$7.95 ppd. House of Pearls, Dept. E, 352 Kings Highway, Brooklyn 23, New York.

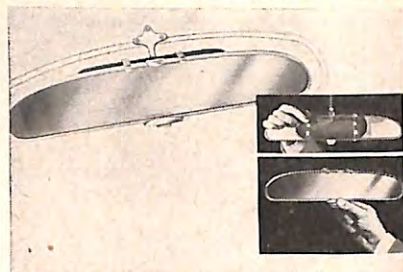

WIDE SCREEN AUTO MIRROR practically gives you eyes in the back of your head. It clips easily on to all auto mirrors. With a flip of the finger you cut out blinding glare . . . but *not* vision. Here's a safety measure every car owner can have economically. \$2.98 ppd. Sta-Dri Products, Dept. E, 147-47 6th Ave., Whitestone 57, N. Y.



KEYED FOR SAFETY. Everytime he puts the key in the ignition, he'll be reminded of his strongest motive for safety: you. Key Tab of top grain leather holds your photo, says "I love you", and urges "Drive Safely". Gold tooling and lettering. Photo frame and keychain are gold-plated. 4 1/2" x 1 1/2". \$1.00 ppd. Elizabeth McCaffrey, Dept. E-12, Orange, N. J.



HORSE-HEAD HUNTING KNIVES. From Finland come these handsome knives, brass topped, hollow ground, hand fabricated, and sheathed in leather. Not only a "man's gift", but a "manly" one, it'll be a sure hit with sportsmen of any age . . . large knife for rough work, the small for cleaning game or fish. 9" long. \$5.98 ppd. Here's How Co., Dept. E, 27 E. 22 St., N. Y. 10, N. Y.

14" TALL HEIDI DOLL

\$1.00

2 HEIDI \$1.95 DOLLS....
Please Add 25c Postage



She is dressed in colorful Swiss costume. Her hair is blonde, her eyes are blue, she wears a slip and panties too. Guaranteed to please any little miss. We don't see how it is possible at this tiny price.

Send For Free Gift Catalog

THE ADDED TOUCH

Wynnewood E12

Pennsylvania

Merchandise shown on these pages can be ordered direct from the companies listed. Enclose a check or money order.



Live Holly Trees

In Pots
3 FOR **\$2.95**
6 FOR **\$5.50**
10 FOR **\$9.00**
ALL PPD.

Make Such Gay Gifts And Festive Decorations

What gift could be more in keeping with Yuletide tradition than real live holly trees? What could look more charming in your own home at the holiday season?

Our pretty little trees have shiny deep green leaves and bright red artificial berries. They come in attractive 2 1/4" fibre pots specially decorated in Christmas red and green. Enjoy them indoors all through the holidays, then plant them outdoors and keep right on enjoying them!

Order by Mail Now For Christmas
Send Check or Money Order
Satisfaction Guaranteed

Stern's Nurseries

GROVE 106 • GENEVA, NEW YORK

Relax in Luxury

DeerMocs

\$8.95

postpaid

MAIL ORDER ONLY

Give men's or women's regular shoe size.

Send for FREE 56-page Catalog featuring leather shirts, exclusive clothing & equipment for sports, country living & gifts

Norm Thompson
Dept. 75 • 1311 N.W. 21st, PORTLAND 9, ORE.



Thick foam rubber insole assures the ultimate in foot comfort.

GENUINE SUNTAN DEERSKIN . . . hand cut by Western leather craftsmen into handsome slippers that mold to your feet for perfect fit. Easy to get on and off, yet hug your feet when you walk. Fold for traveling. Washable! Satisfaction guaranteed or your money back.

the gift supreme!

SPRUCE ELECTRICAL MANICURIST

Only 5 1/2" diameter. For easy, safe personal use. Automatic attachments give superb professional-type manicures quickly, conveniently. Safely erases calluses from the feet, too! Recommended by thousands of users. Fully guaranteed. Made for many years of service. We guarantee pre-Christmas delivery on orders received by Dec. 20th.

ONLY \$29.95
ORDER RIGHT NOW!

A Wonderful Gift! A Pleasure to Use!

ABAR MFG. CO.
quality products since 1931
8851 Woodland Ave., Cleveland 4, Ohio

- Nail Shaping
- Cuticle Lifting
- Cuticle Whisking
- Oil Massaging
- Nail Buffing
- Callus Erasing

SHOPPER



DECK THE HALLS with Fresh English holly. The glossy green sprays are fresh-cut and specially treated to keep their forest-green beauty. 15 big sprays, topped with a sprig of Mistletoe, are shipped boxed, to arrive Christmas week. \$2.50 ppd. per box. Northwest Corner Store, Dept. E, P. O. Box 1138, Longview 9, Washington.

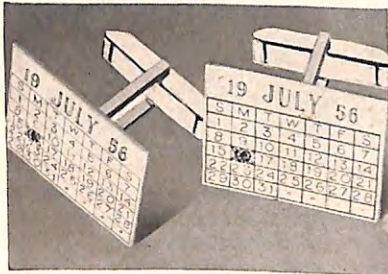

A DATE TO REMEMBER will be marked for you by a hand-set synthetic ruby in these Calendar Cuff Links. You can order a calendar accurate for any month and year. If you're looking for an original gift that really says "For you only", here's a happy answer. Sterling silver or gold-filled, \$15.00. 14K solid gold, \$33.50 ppd. Holiday House, Dept. E, Upper Montclair, N. J.



DON'T FUMBLE for your fare. Petite Coin Compact holds up to \$3.24 in half dollars, quarters, nickels, dimes and pennies. It's made of translucent red styrene embossed in gold. A perfect stocking stuffer (extra nice when filled). \$1.00; 6 for \$5.00; ppd. Western Classics, Dept. E, Box 4035, Tucson, Arizona.

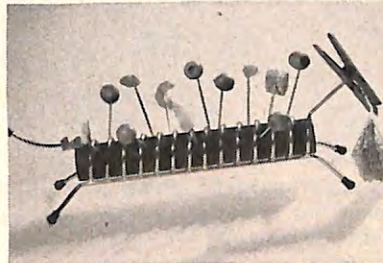

PUT ON THE DOG. Serve your tidbits on the Party Pooch. He'll hold a tempting assortment of olives, cheese meats, all sorts of snacks. The center log of deep black wood is set off by the gleaming brass frame and legs. Log is slotted to hold picks. Get one for yourself and several for gifts. \$1.50 ppd. Monogram Shop, Dept. E, 84 Westminster St., Providence, R. I.

Except for personalized items, there is guaranteed refund on all merchandise returned in good condition within 7 days.

Enjoy

BISOLAR "SUNSHINE" ALL WINTER LONG!



Suntan with a Battle Creek BISOLAR LAMP

Enjoy a much-admired "sun-tanned look" all year—plus wonderful health protection for yourself and family. At the "snap of a switch" the BISOLAR Lamp provides made-to-order light that tans faster than the sun. Yet if you relax and fall asleep, automatic Soltimer Switch turns lamp off at time you set—prevents overexposure! Scientifically balanced artificial sunlight contains both ultra-violet-infrared rays. Pedestal, wall and ceiling models. Money-back guarantee. Write today for Free Literature!

Ceiling Model with Timer Only \$76.50

Battle Creek

EQUIPMENT COMPANY
Battle Creek 13, Michigan



Free PLASTIC CHEESE PRESERVER BAG AND BEAUTIFUL FULL COLOR BROCHURE SENT ON REQUEST!

A gift to please WISCONSIN CHEESE GIFT PACK NO. 5

A truly representative assortment of Aged Wisconsin cheese shipped to you at the peak of their flavorful goodness. Contains Alpine Swiss, Brick, Smoked Cheese, Dessert Cheese, Baby Gouda, Cheddar, Blue Cheese Roll and Wine Cheese. Postpaid \$6.90 Net Weight over 4 lbs. MEMBER WIS. GIFT CHEESE SHIPPERS ASSOCIATION. **THE SWISS CHEESE SHOP** BOX 4294 • MONROE, WISCONSIN

BUY DIRECT and SAVE UP TO 1/2 on ITALIAN ACCORIONS EASY TERMS



AMAZING NO RISK OFFER... Now you can afford a world famous Accordion of finest tone and breathtaking beauty! Low wholesale prices save you half and more.

5 DAYS FREE TRIAL

ACT NOW! FREE—
• Music Stand
• Home Study Course
• Deluxe Case
• Lifetime Guarantee

MONEY BACK GUARANTEE

Buy direct from world's largest dealer. Save 50% or more. 80 newest models to choose from. Extra bonus gifts if you buy now. Satisfaction guaranteed or money back. Trade-ins accepted. Low down payment; pay little as \$10.00 a month. Try before you buy on FIVE DAY TRIAL. Rush coupon now for FREE color catalog and wholesale price list. Write TODAY. **Accordion Manufacturers and Wholesalers Outlet**, Dept. K-126 2003 W. Chicago Ave., Chicago 22, Ill.

COLOR CATALOG FREE
Mail Coupon

Accordion Manufacturers & Wholesalers Outlet
2003 W. Chicago Ave., Dept. K126, Chicago 22, Ill.
Send FREE Color Catalog and price list.

NAME _____
ADDRESS _____
CITY _____ STATE _____



THRILLING SNOW SKATES
\$1.79
Pair, ppd.

For little "Winter Sports" too small to cope with skis—here are skates that take them skimming over the snow almost as swiftly—and safely! Actually, these are miniature skis, 2 1/4" across, 12 1/2" long of steam-bent hardwood with grooved bottoms and metal heel plates. Fit ages 4 to 11. Order No. 3695-6, Snow Skates, \$1.79 by mail, postpaid.

WRITE FOR FREE GIFT CATALOG!

Miles Kimball
415 Bond St., Oshkosh, Wisconsin

New Crop #1 Unshelled **PECANS**
... in colorful Mexican



FIESTA BASKET

Big Stuart and Success Pecans, washed, polished and machine graded.

5 lbs. \$6.00 ppd.

FOR GROUP FUND-RAISING!
Pecan Halves, 1 lb. cello. bags, \$1.40, 25 or more. Send for colorful folder, prices, etc.
DEEP SOUTH PECAN CO., Dept. EK, Biloxi, Miss.



"Give Your Son the GIFT Every Boy Longs For
The Body Building Secrets of 21 SPORTS CHAMPIONS"

says **Mickey Mantle**,

Yankee Star Outfielder, Triple Crown Winner

Now, for the first time, The National Sports Council makes it possible for you to give your son scientific Sports Training by World Famous Champions — RIGHT AT HOME.

In as little as fifteen thrilling minutes a day, he can learn the secrets of his sports heroes — achieve athletic power, gain the perfect control, stamina, and self-confidence necessary for leadership.

Write today for **FREE FULLY ILLUSTRATED CATALOG** with full details of the Greatest Gift You Can Give Your Boy!

Medically approved. Endorsed by Sports Experts, Health and Civic Leaders, Parent Teachers Associations.

The NATIONAL SPORTS COUNCIL
Dept. BU-126, 33 West 46 St.
New York 36, New York

Let 21 Great Athletes Train Your Boy AT HOME

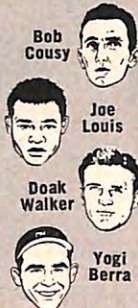

and 15 other sports "greats"



Santa's Best Gift for Dogs

Give your dog luxurious comfort, relief from scratching, restful sleep in its soothing cedar aroma. Kills fleas, doggy "B.O." So enticing he'll forsake chairs, sofa. Long-lasting. Flea-Scat-Pad, 15x28 in., \$3.49; Super size, 28x36 in., \$4.98.

Kitty Cootie-Chaser the pad for Cats—hear pussy purr in luxury and revel in its aroma. Kills fleas and lice. 14x18 in., \$2.49.

Money-Back Guarantee—save postage by sending checks or M.O. Sudbury Laboratory, Box 47E, South Sudbury, Mass.

WHAT IS YOUR HOLIDAY PLEASURE—TURKEY OR HAM?



It's the Rare Forst Smoke-Sweet Flavor—a Family Secret for Generations that Makes the Difference!

Either Delicacy—Unforgettable for Christmas Feasting and Gifting!

The choicest turkeys, applewood smoked, aromatically spiced, golden brown... succulent Southern style hams cured and smoked to insure that different Forst flavor. No cooking—no shopping! Forst delicacies sent to you ready to serve!

FORST CATSKILL MOUNTAIN SMOKED TURKEY
Whole—8 to 20 lbs., net wt. \$1.75 per lb.

FORST CATSKILL MOUNTAIN SMOKED HAM
10 to 18 lbs., net wt. \$1.50 per lb.

Order today. Please enclose gift list, complete addresses and delivery dates with your check. All delicacies gift wrapped, shipped prepaid in U. S. . . FREE on Request—NEW full color catalog.

THE FORSTS, Route 434, Kingston, New York
Important: All Forst Products are Gov't Insp'd

Elks FAMILY SHOPPER



ATOMIC LIGHT BULB. It's magic the way this bulb lights up in your hand, ear, wherever you place it. Baffle your friends but don't reveal its secret: that its self-contained power is turned on by touching metal or metal foil to its base. Light it with a coin, ring, metal watch. \$1.00 ppd. Wayne Mfg., Dept. E, Wayne, Pa.

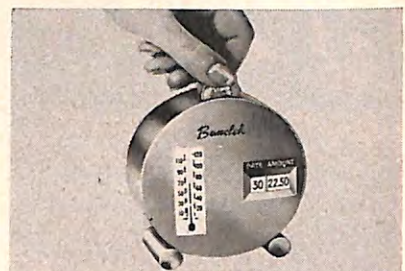

THRIFT THERMOMETER. Every day when you check the temperature, you'll be reminded to drop a quarter into this Thermometer-Date-Amount Bank. The date changes only when you deposit the coin. Running total is also recorded. \$2.95 ea., 2 for \$5.75 ppd. Leecraft, Dept. ELW, 300 Albany Ave., Brooklyn 13, New York.



COWBOY CAPERS call for Fur Chaps and Vest and these of genuine fox fur will certainly please your young broncho buster. They're authentic in style, rugged-looking, but soft and cozily warm. Age 2-4 (Small); Age 4-6 (Medium); Age 6-8 (Large). Vest, \$3.95; Chaps, \$5.95 ppd. Greenhall, Dept. E, 1133 Broadway, New York 10, N. Y.



SWISS WATCHES—for man, woman and child. Handsome and rugged, they have shock and water-resistant jeweled movements, radium numerals, sweep second hands, are guaranteed for 1 year. Man's comes with stainless steel expansion band; woman's or child's with gray leather strap. Only \$8.98 ppd. for either. The Nassau Co., Dept. E, 200 W. 34 St., New York, N. Y.

Unique and Durable Hawaiian Wood Rose CORSAGE
\$2.95 POSTPAID



Imaginative hand-crafting has fashioned this unusual Hawaiian flower with its exquisite shades of Roman Gold 'n bronze into a corsage any lady will wear with pride. Interchangeable ribbon and neutral coloring make it the ideal accessory for suits, furs and most afternoon and evening wear.

ORDER NOW FOR PROMPT DELIVERY

No C.O.D.'s please, send check or money order with order. Add 25c for Canadian deliveries. Quantity Prices on Request.

Ann Imports
P. O. BOX 1637 HOLLYWOOD - IN - FLORIDA

TEXAS 56
XX0000

New! . . . Unbreakable NUMBER PLATE FRAME

Snaps on in a jiffy. Decorative, flexible plastic can't rattle or scratch. Fits all standard 6" x 12" plates. Available with or without Elks Emblem. Colors: Black, White, Red, Yellow, Green or Blue. Please specify color.

with emblem	Pair	without emblem	Pair
	\$1.50		\$1.25

Postpaid. No C.O.D. please! Money back if not satisfied.

BROCK'S NOVELTIES
P.O. Box 151 Lunenburg, Mass.

41 Surplus Twist DRILLS \$2



For hand or electric drills. Brand new, genuine hardened carbon tool steel drills from 1/16" through 1/4". Each drill designed and tempered to give 1800 drillings through steel, aluminum, iron, wood, plastic. Sells in the stores for up to \$6. **\$2 complete set postpaid.**

MONEY BACK IF YOU DON'T AGREE THIS IS THE BEST TOOL VALUE EVER!

Send Check, Cash, Money Order, WE PAY POSTAGE . . . If C. O. D. You Pay Postage

SCOTT-MITCHELL HOUSE, INC.
DEPT. 5112, 611 BROADWAY, N. Y. 12, N. Y.

CUT TV REPAIR BILLS

Check All TV Radio & Picture Tubes Yourself!



new!

When a TV or radio repairman makes a home call to check your set, the first thing he'll do is test the tubes—and most times that'll be the trouble. Just plug any tube into this tube checker and Neon Light will show whether it's good, save you enough money the first time to pay for the \$3.95 it costs. Also has test leads to check circuits on motors, appliances or any electrical device. Strong vinyl case. Safe—quick— Foolproof. No technical knowledge needed. \$3.95 ppd. **MONEYBACK GUARANTEE.**

CHABON SCIENTIFIC CO., 411-H Lincoln Bldg., New York 17, N. Y.

Elks FAMILY SHOPPER



KNOTTY PINE MEMO PAD keeps the note paper rolling along. It holds a full roll of adding machine tape (refills at any stationer.) Holder has hand-rubbed pine finish and brass tear-off strip. 12" high x 3" wide. With paper but not pencil. \$2.95 plus 15¢ postage. Laurie & Co., Dept. EK., 507 5th Ave., New York 17, N. Y.



SUGAR MICE run up the Christmas tree to make a deliciously different decoration. Following an old English custom, you tie these merry mice to the tree by their extra long tails. Each sweet is 1½" long, some pink, some white. Box of 25 assorted Sugar Mice, \$1.00 ppd. Spencer Gifts, A-7 Spencer Building, Atlantic City, New Jersey.

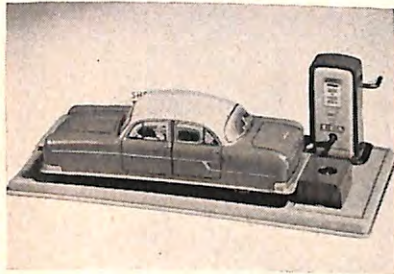

FILL 'ER UP. Miniature Filling Station really works. Electricity, instead of gas, is pumped into a storage battery in the 6" red metal car which then takes off like a shot. Realistic "Shell" pump is 2½" high. Connect pump to tank, crank handle, and away she goes! Complete station, 9" x 4". \$2.49 ppd. Page & Biddle, Dept. E, 21 Station Road, Haverford, Pa.

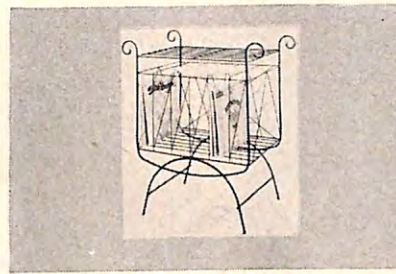

MADE FOR MUSIC. Empress Record Rack, graceful and spacious, will hold a record player on the top shelf, 125 albums in its compartments. There's an extra shelf to hold the empty album covers. Wrought iron, styled in Empire Era elegance. 33" high x 23" x 17". Black with brass trim. \$24.95, exp. chgs. coll. Leslie Creations, Dept. 172, Lafayette Hill, Pa.

Genuine 6 INCH TAMPA PALMA at a 42% saving

For those who delight in the flavor of imported Havana Tobacco

SMOKE SAMPLE BOX AT OUR RISK

We want you to smoke these Tampa Palmas at our risk, and if you don't think they equal any 26¢ Palma on the market, they're "on the house." You're the judge and jury.

One of the largest high-grade cigar factories in Tampa, Florida has a temporary surplus production in their regular 26¢ size. That's why we can offer these Genuine 6 in. TAMPA PALMAS at 42% under the 26¢ price while the quantity lasts. These are luxury cigars, all 100% long filler, No scraps, No dust. They're extra Mild and Mellow because the imported Havana Wrappers are selected light Claro-Claro color from the Vuelta Abajo district of Cuba.

To make this special value possible they left off the fancy bands, labels and boxes and put the cigars in a lower tax bracket. But all the mildness, flavor and smoking pleasure are exactly the same as the regular 26¢ cigar under the maker's brand name (which we're not allowed to mention). Here's how you save 42%. Send us only one dollar and we'll send you postpaid a sample box of 7 Tampa Palmas, that's 42% under the 26¢ price. Now test smoke as many as you like, if not delighted, return the balance for your dollar back. You can't lose. Sorry only 1 sample box to a customer.

WALLY FRANK Ltd. Dept. P104
132 Church St., New York 7, N. Y.

Send me the sample box of 7 Tampa Palmas, on your money-back guarantee as described above. Enclosed find one dollar. (Please print name and address below)

1000 Name & Address Labels \$1.00



Your name and address printed on 1000 fine quality gummed labels. PACKED IN PLASTIC BOX. Use them on stationery, checks, books, greeting cards, records, etc. Your choice of 3 lines printed on fine quality gummed paper. Six orders for \$5. THIS IS A SPECIAL OFFER. A sensational bargain. Ideal for gifts. Makes a wonderful, useful present. Satisfaction guaranteed. **HANDY LABELS**, 1206 Jasperson Building, Culver City 1, California.

RELAX IN



PATAKWA MOCCASINS — Ideal Gift from the Indian Reservation Country of soft, washable sueded cowhide, with flexible padded soles. **BLISS TO WEAR** indoors or out with cuffs rolled up or down. **HANDCRAFTED** in Natural, Turquoise, Brown, Red, Golden Corn, Russet, Indian White.

FOR MEN AND WOMEN	in sizes 4 to 8.....	\$4.95
	in sizes 9 thru 12.....	\$5.95
FOR CHILDREN too, in natural or brown only.	Sizes 11, 12, 2.....	\$3.95
Sizes 5, 7, 9.....		\$2.95

Send cash, check or m.o. For COD's send \$2 deposit. **Immed. delivery. Satisf. guar. Gift orders carefully handled.** Box 4035, Dept. EP-1 Tucson, Arizona

"MY GREY HAIR IS A NATURAL LOOKING COLOR AGAIN" says JAN GARBER, Idol of the Airlines

"TOP SECRET gives my grey hair a natural looking color!" says famous dance band leader Jan Garber. "I noticed results after just a few applications. And TOP SECRET is easy to use—doesn't stain hands or scalp. TOP SECRET is the only hair dressing I use."



A FAVORITE OF THE STARS

TOP SECRET has been a favorite with famous personalities for years. Exclusive formula imparts a natural looking color to grey or faded hair. Does not streak or injure hair; does not wash out. Send \$3.00 (Fed. Tax incl.) for 3 oz. plastic container. (Convenient for traveling, too.) Ppd. No COD's, please. Money back if not delighted with results of first bottle. Albin of California, Room 124, 1401-91 W. 8th St., Los Angeles 17, Calif.



STAINLESS SHEFFIELD STEEL 21"

BARBECUE SET

Imported from England A handsome, last minute Christmas arrival—just in time for Christmas, sure to create a sensation with outdoor chefs everywhere. All implements riveted to 14" hardwood burn-resistant handles. Stainless Turner, Forged Stainless Fork, and Carving Knife (with serrated tip). Leather thong for hanging. Comes in rustic wood gift case.

\$10.95 postpaid

Here's How Co.

Dept. Ek-12
27 E. 22nd St., New York 10, N. Y.



WONDERFUL Butterfly PILLOW

Make hours in bed refreshing, try this amazing new Butterfly Pillow created by Better Sleep Inc. to bring relaxed, contented sleep where conventional pillows fail. Enjoy its contoured, air-cushioned, neck supporting head cradle and its two side wings, just the right height and cushioning to assure neck alignment and soothing sleep comfort. Best of all, you adjust it for height, softness and temperature. Actually cools your head and shoulders all night if desired, even in summer. Use it for two weeks and amaze yourself with restful, natural sleep again. Excellent for travel and TV. Easier on "hair-do's". Money back if not satisfied even up to 30 days. Ideal gift. Immediate delivery. C.O.D.'s extra. Send check NOW for only \$3.95 to

BETTER SLEEP Inc.

Dept. 468, New Providence, New Jersey

You will ENJOY
pleasant, vigorous
VIBRATORY MASSAGE
with the Genuine
**Battle Creek
HEALTH®
BUILDER**



"TOPS" for
the Home, for Athletic Clubs,
for Reducing Salons—for MEN and WOMEN!

Enjoy the relaxing, stimulating benefits of efficient vibratory massage! Health Builder gives you pleasant, scientific deep-tissue manipulation—"at the snap of a switch." Helps weight and figure problems, muscle-toning, blood circulation. Widely used in Health Institutions. Built for years of service—fully guaranteed. WRITE today for literature and new booklet, "BE GOOD TO YOURSELF!"

**Battle Creek
EQUIPMENT CO.**
Battle Creek 11, Mich.

GET
YOUR
COPY



SHOE SHINE KIT

E-Z Shine Holders are made of strong aluminum. Detach from wall bracket. 3 changeable toe plates for men, women and children (for all size shoes). Chrome-like finish. C.O.D.'s pay postage. Look sharp at low cost. Guaranteed to give long, hard family usage.

Penna. residents add 3% sales tax

A useful
gift
for all
occasions



\$2.95

**WAYNE
Mfg. Co.**

WAYNE E-12, PENNA.



The Modern way to list
Telephone numbers

CALLDEX

Is anchored securely to the base of telephone. Has space for two hundred names and numbers. Fits snugly out of sight under phone.

\$1.00 ppd.

Travers Merchandise
309 Travers Ave. Dept. 1
Mamaroneck, New York

NEW! ELECTRIC! SUPER CONTROL ANTI AIRCRAFT JEEP



It drives, turns . . . all parts
move as you control them

ONLY
\$2.98
Post
paid

Action Galore! Battery operated. Throw the switch and the jeep takes off. Left turn, right turn, straight ahead, backwards and forwards (even curves in a figure eight—all directions!) YOU control the action. Front window folds down, turret rotates with 2 guns. Four heavy threaded rubber tires with one spare. A rugged toy. Strong Army green metal. Size: 9 1/2" x 3 1/2". Easy instructions incl. NO COD'S. Order several for GIFTS!

MANOSTRO COMPANY Dept. E-1
Suite 14, Engleman Bldg. Manistee, Mich.

Elks FAMILY SHOPPER

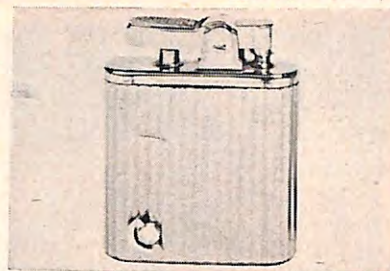

MUSICAL LIGHTER. Press the trigger and light her cigarette to the tune of "Smoke Gets in Your Eyes". This gem of a gift is gold plated, lightweight, equally at home in purse, pocket or on the coffee table. 2 1/2" deep by 2" wide. Luxuriously boxed in a red chamois case. \$9.95 ppd. incl. tax. Spencer Studios, Dept. E. 8446 Grandview Drive, Hollywood 46, Calif.



ANGEL BELL TRIO. Don't be fooled by their star halos—they're full of angel antics. For instance, the middle one has a sling shot behind her back, loaded with a star! The 2 1/2" Baby has a finger in her mouth and holds an angel doll. Ceramic with tiny bell clappers, red and white costumes, gold scrolled. Trio, \$1.95 ppd. Miles Kimball, 99 Bond St., Oshkosh, Wis.



PATTI, THE PRAYING DOLL joins her little mistress in a bedtime prayer: "Now I lay me down to sleep, I pray the Lord my soul to keep, God bless Mommy, God bless Daddy, Amen." Soft and cuddly, she stands 20" tall when erect. The perfect bedtime companion, she's only \$4.95 plus 35¢ postage. Interior Trends, 56E Underhill Ave., Brooklyn 38, New York.



SPEEDY STITCHER GIFT KIT. This popular automatic awl—which stitches leather and the toughest textiles like a machine—is newly packaged in a kit. Awl (holding bobbin of waxed thread in handle. 3 types of needles in chuck); 3 extra needles, 180 yard cone of waxed thread are included. \$3.49 ppd. Sportsman's Post, Inc., 366 Madison Ave., Dept. E, New York 17.

Deliciously Different
SMOKED SNACKER
Five seafoods from the world famous Pacific Northwest—deliciously smoked to savory perfection. Crab's legs, smoked Oysters, Shad, Sturgeon, Salmon—each a meaty treat of incomparable flavor and enjoyment. Surprise your guests and also send us an unusually different gift. \$4.95 ppd.
Write for Catalog
**ZAMBONI'S
NORTHWEST
CORNER STORE**
P.O. Box 1138
Longview 9, Wash.

FREE
GIANT ILLUSTRATED WHOLESALE CATALOG
Buy wholesale . . . cameras, electrical appliances, toys, hunting and fishing equipment and lots more.
Write today, Dept. EL
SANTA FE DISTRIBUTING CO.
1321 Main, Kansas City, Mo.

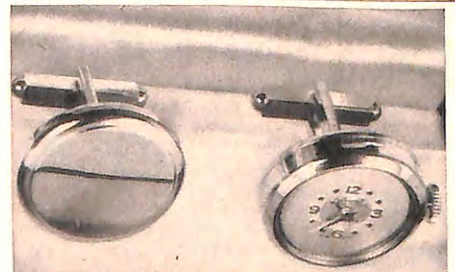

IMPORTED CUFF LINKS—the perfect, unusual gift for him or her. One a jeweled, shock-resistant Swiss watch (penny-sized) with an unbreakable crystal, and a YEAR'S written guarantee. The other opens up into a double, two picture locket. (Can be monogrammed, if desired, by your local engraver.) In tarnish-proof, golden finish. Exclusively ours at only \$14.95 postpaid. "Delivery Guaranteed For Xmas."
THE NASSAU CO., Dept. E
200 WEST 34th STREET, NEW YORK 1, NEW YORK

COLOR TELEVISION TOYS

130 PIECES \$1.00
LARGE SIZE IN FULL COLOR Newest toy sensation. Realistic actors, actresses, acrobats, animals, dancers, clowns, cowboys, singers, props, over 130 performers, TV cameras, etc. All cut out of rigid book-stock and stand up. Average 5" tall. Fun for ages 2-14. Children set up scenes and put on TV shows: westerns, circuses, variety shows, plays, etc. Gayly colored characters make delightful toys for toddlers, too. Educational "Director's Kit" explains authentic TV equipment and how to stage shows. FREE—2 funny TV puppets, arms-legs move. Send \$1 plus 25c for postage and handling (total \$1.25) for each set or 4 sets for \$4 to: **E. P. Mather,** Dept. F, 31 Francisco St., Caldwell, New Jersey.

Elks FAMILY SHOPPER

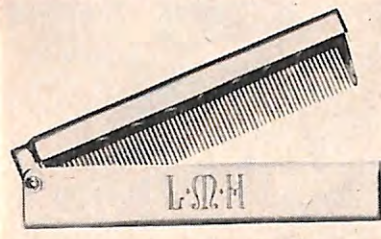

FOLDING COMB. For a man's pocket or a woman's purse, this compact comb is handy and handsome. The tortoise shell comb folds into a gold-or-silver-plated metal case which may be personalized with 2 or 3 initials, or first name. In flannel bag, boxed, it's a "little gift" find. \$1.50 ea., 2 for \$2.75 ppd. Ruth Brawer, Box 4035, Dept. ELC, Tucson, Arizona.

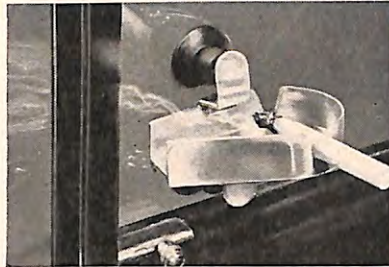

KEEP ASHES OUT of your auto with the Ash-A-Way Vent Window Ash Tray. Mounted on any vent window of car, it holds cigarette within safe, easy reach. Vacuum caused by the slightly open window draws out ashes. It's inserted in a bracket held on window by suction cups. Beautifully chrome-plated. \$1.50 ppd. Dur-Ad Services, P. O. Box 61-B, Charlevoix, Michigan.



KEEP HIM NEAT. Give him the Valet Hanger that "takes" a man's suit the way he takes it off—first the jacket slips onto the "natural shoulder" hanger; then a pushbutton pops the trouser bar forward, the pants go over it, pushbutton releases it. Black lacquer, shiny brass, red trim. \$1.95; 2 for \$3.95; add 25¢ postage. What's New Shop, Dept. E, Wynnewood, Pa.

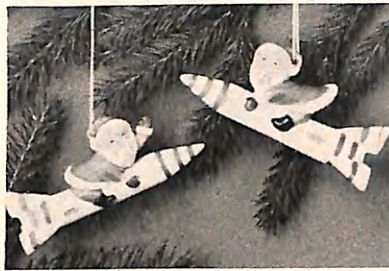

SANTA ON A ROCKET. Brightest, new addition to zoom into the Christmas scene. Dressed in bright red with black boots, Santa rides a sparkling white and red rocket. A strong cord, strung through Santa's floppy red cap, loops over pine needles. 1 3/4" high x 4" long. Sold in pairs only. \$1.00/ pair; 6 pairs, \$5.00 ppd. Taylor Gifts, Dept. E, Wayne, Pa.

EASE TIGHT NECKBANDS NEW WONDERFUL COMFORT with amazing WONDER BUTTON

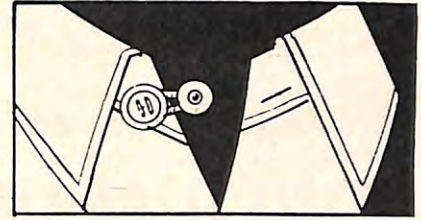

Adds as much as 1/2 size to that too tight or highly starched collar. Saves money; no need to discard that favorite shirt. Expanding spring loop slips easily onto collar button, then the attached all-metal button is inserted in buttonhole. Cannot be seen behind tie. Can be easily transferred from shirt to shirt. Machine tooled to perfection and guaranteed. You'll say it's the best investment you ever made. Gift boxed. Order today at this special introductory price. **\$1.00 POSTPAID**

**SCHAFFER PRODUCTS CO., Dept. 127
UNION CITY, MICHIGAN**

GIVES YOU \$100⁰⁰ a Year Automatically



with each Perpetual Date & Amount Bank. 25c a day keeps Date up-to-date. Also totals amount saved. Forces you to save daily, or Calendar won't change date. Save for gifts, vacations, payments, etc. Use year after year. Start now. Reg. \$3.50, now only \$1.99 each; 3 for \$5.75; 6 for \$11.00 postpaid. Mail

cash, check or money order to LEECRAFT, Dept. EL, 300 Albany Ave., Brooklyn 13, N. Y. Sold by mail only—prompt delivery.



PERSONALIZED HOSTESS TRAY

Charming way to serve! Colorful metal tray is hand painted with first names under appropriate Gay Nineties illustrations; last name follows invitation to join in a drink. Molded easy-grip rim. Measures 15" x 9". PRINT FIRST AND LAST NAMES. 2 week delivery. Postpaid **\$1.98.**

**CHRISTMAS DELIVERY GUARANTEED
ELRON, Inc., 225 W. Erie St., Dept. 269, Chicago 10, Ill.**



CHARMING CENTERPIECE PLANTER AND SWANS

3-Piece Salt and Pepper Set ALL Complete with Colorful Floral Display For Only **50¢**

Bargain—to get new customers! The two lovely Swans (one pours salt, the other pepper) stretch their long graceful necks as if drinking from the charming Flower Ring. An enchanting, imported creation; so pretty as a table centerpiece, or on mantel, end-table, etc. Artistically made of hand-decorated, gleaming white ceramic.

THE CENTER OF ATTRACTION! Comes complete, filled with lovely, multi-colored simulated flowers. If you desire, remove flowers from Planter, and use it for other purposes. Satisfaction guaranteed or money back. Not more than 2 Sets to a customer at this low price. Add only 20¢ to each Set ordered for postage and handling. No C.O.D.'s please.

DOBBS PRODUCTS CO., 1255 S. Wabash, Dept. 341, Chicago 5, Ill.

NEW! SCOTCH OR BOURBON
Flavored WHISKEY MOUTH WASH
\$1.95 Each POSTPAID

What a terrific gag-gift idea. A little brown juze comes with 8-oz. of Scotch or Bourbon flavored mouth wash. But don't worry, it's only 5% alcohol and won't turn your tyecon into a tippler. Better kiss him good morning before he hits the bottle.

SCOTCH, RYE, BOURBON FLAVORED TOOTH PASTE
POSTPAID PER TUBE \$1.00; 3 TUBES PPD. \$2.75
Pa. Residents Add 3% Sales Tax. Send For Free Catalog

TAYLOR GIFTS Wayne E-12, Penna.

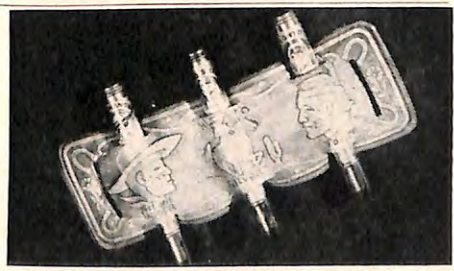

THE LONE RANGER "writes" again 3 ball point pen "bullets" that write blue, red & green, slip over a belt in a leather cartridge holder, embossed with the Lone Ranger, Silver & Tonto. Only **\$1** ea. Special Price of 6 Sets for \$5.

Immediate delivery, No COD's. Send cash, check or m.o. BOX 4035, DEPT. ELC, TUCSON, ARIZONA

WESTERN CLASSICS

POCKET ALARM WATCH

A USEFUL GIFT FOR ANY MAN

Fine 7-jewel Swiss-made pocket alarm watch can be set to go off at any time, rings with a sharp, clear tone. Back opens to form a stand, makes watch double as a desk or night-table clock. Second sweep, luminous dial, hands. Size makes it handy for business or sportsmen. 1 year guarantee.



\$1325 ppd.

Sold on a moneyback guarantee.

PRINCE ENTERPRISES, 103-N PARK AVE., N.Y. 17



"TOWN & COUNTRY" THERMA GLASSES

Keep drinks hot or cold to very last sip! Sweatproof, unbreakable. Lovely satin finish, soft colors of melon, almond green, citrus yellow, charcoal, and white rice trim. Gift packaged in assorted colors. Set of 8, with twig stirrers, \$5.95. Set of 4, \$2.95. Add 35 cts. postage. Helen Finch, Suite 524, Pioneer American Bldg., Houston 2, Texas.



Full Color—Wall Size International
WORLD MAP

OR UNITED STATES, CANADA
 ASIA, AFRICA
 EUROPE & NEAR EAST, SOUTH AMERICA
 AUSTRALIA WITH PACIFIC ISLANDS,
 NORTH AMERICA

They are all wall size! 33 inches x 50 inches. Heavy duty durable stock in 8 full colors with clear type to instantly identify any corner of the globe. All in precision detail. Smart as a mural. Educational for children's rooms, den, office, civic, schools, etc. Order Direct today! Send \$1.00 each prepaid. Your choice, any map, any assortment 3 for \$2.75—any 6 for \$5.00. Mention maps by countries desired.

TERRY ELLIOTT CO., Dept. MP-125
 135 East 44th St. New York 17, N. Y.

WROUGHT IRON SWITCH PLATES

ATTRACTIVE PRACTICAL and DURABLE electric switch ornaments.

Designed to add warmth and beauty to the walls of any styled home from Provincial to Modern. These handsome black wrought iron scrolled-framed plates fit over any wall switch or outlet. Give added protection to walls from finger marks. Ideal for any room . . . Living Room, Kitchen, Bed Room, Den, Foyer, etc.

1 Single Switch \$1.35 ea. 2 Triple Switch \$4.95 ea. 3 Duplex Outlet \$1.35 ea. 4 Double Switch \$1.65 ea. 5 Combination Switch and Outlet \$1.95 ea.

Other types available including Despard Plates No C.O.D.'s please. We pay postage. Money refunded if not delighted. Order NOW!

Write for FREE Gift Catalog

Laurel & Co. Dept. E-18, 507 5th Ave. New York 17, N. Y.



LOW PRICE ELECTRIC STARTER FOR YOUR GAS LAWN MOWER. E-Z-WAY fits all motors, used with any standard 1/4" electric drill. No more pulling rope. E-Z-WAY fits all starter pulleys, disengages as motor starts. E-Z-WAY only \$3.95. If you have no electric drill: SPECIAL OFFER—E-Z-WAY attachment FREE with Thor Speedway 1/4" Drill at regular prices, Jacobs chuck \$19.95 or plain chuck \$16.95 PPD. (No COD's) NORWOOD SALES, Columbus 5, Ohio

1000's of uses

genuine SUEDE LEATHER WHOLESALE! only 39¢ ft. postpaid

SIZES
 2 full sides approx. 16 ft. \$6.25
 1 full side approx. 8 ft. \$3.75
 1/2 side approx. 4 ft. \$1.98
 Sample swatches .25
 Add .50 for shipping & packing

COLORS
 Buckskin Brown, Forest Green
 Blood Red, Royal Blue, and White

We have purchased nearly a carload of premium suede leather at a fraction of its real value. Beautiful tanned leather can be offered to you for a limited time at only 39¢ ft. These handsome hides can be cut and sewn like cloth. Genuine leather lasts a lifetime. - loads of uses - - purses, belts, pillows, bookcovers, jackets, skirts, wallets and sporting goods items. Cover chairs or use as throw rug. It's simple and fun to decorate with our easy instructions and save \$. Order now at this unheard-of low price. Specify color and size. Satisfaction guaranteed. Dozens of patterns, special needle and thread free with your order. Send to WHOLESALE IMPORT CO., Box 12-C, San Gabriel, Calif.

Relaxing COMFORT

A Perfect Gift

This ingenious Knee Lift Cushion gives you contour chair and hospital-bed comfort, achieved by slightly flexing the knees. Now this comfort can be enjoyed in your own home. Your back, hips and legs relax, tensions vanish, sleep comes easily and naturally. Many back and leg aches magically disappear. Wonderful gift for restless sleepers, bed readers, invalids and during pregnancy. Used by many doctors and hospitals. Money back guarantee. Immediate delivery. Only \$2.98.

BETTER SLEEP Inc., Dept. 469, New Providence, N. J.

20 LARGE NEW TOWELS 5¢ EA

Incredible, but true! 20 large-size, new towels (not seconds) in beautiful colors and white, only 5¢ each! Minimum order 20 for \$1.00. (Pls. include 5¢ extra for postage and handling, or \$1.05 in all for 20 Towels.) Others charge \$1.00 for only FIVE unwoven cotton and rayon towels like these, but we made a terrific purchase and are passing the savings on to you. LIMIT—3 orders per customer. Money back guarantee. Order TODAY!

Towel Shop, Dept. 872, Box 881, St. Louis, Mo.

YOUR OLD FUR COAT INTO NEW CAPE, STOLE!

STYLE #55

\$22.95 COMPLETE

ORDER BY MAIL 2-3 week delivery

Send for FREE Style Book

I. R. Fox, fur remodeling specialist, re-styles your old, worn fur coat regardless of condition into glamorous 1957 cape or stole. One low price, \$22.95 complete! This low, low price includes cleaning, glazing, repairing, lusterizing to new sheen, remodel completely, plus a lovely NEW LINING and INTERLINING & Monogram at no extra cost. The thrilling result—a luxuriously beautiful cape, stole or jacket. SEND NO MONEY!

Just wrap up your old fur coat, mail it to us now. Send your dress size and height on postcard. Pay postman \$22.95 plus postage when new cape arrives. Or send for FREE Style Book now! Many different styles to choose from. Write:

I. R. FOX, 146 W. 29th ST., DEPT. E-30, N. Y. C. 1, N. Y.

Elks FAMILY



BIB 'N WHISTLE for happy mealtimes. Santa's jolly face beams forth from this bib. When you squeeze his red nose, it whistles! It's made of red and white plastic-backed cotton twill, and of course is washable. Whistle is easy to remove and put back (for washing). \$1.25 ppd. Sirco Products, Dept. E, 114 East 40th St., New York 16, N. Y.

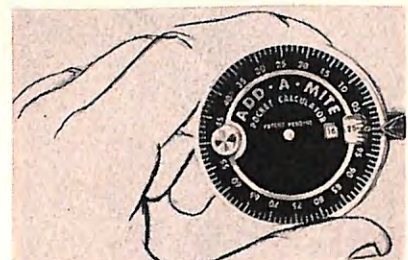

SUPER MARKET SHOPPERS can keep accurate track of their purchases with Add-A-Mite. This tiny calculator adds or subtracts any amount from one cent to \$25, tells you your total bill before you reach the check-out stand and helps you keep your budget in hand. Of polished aluminum, \$2.00 ppd. Arkard Service, Dept. E, 5434 N. Glenwood, Chicago 40, Illinois.



"REVERSIT JACKET", completely weather-proofed and lined with 100% prime down. One side is Autumn Brown Nylon; the other, brilliant Hunter Red Poplin. It has a fitted waist and plenty of pockets, including a reversible zippered pair for hand warming. Sizes 36-44, \$44.89; 46-52, \$49.89. Add 75¢ for shipping. Alaska Sleeping Bag Co., Dept. E, 309 S. W. Third Ave., Portland 4, Ore.

Please mention The Elks Magazine when writing to our Elks Family Shopper Advertisers.

SHOPPER



STAR FINDER. With this "key to the heavens" you can identify 135 stars and planets and 45 constellations. It projects illuminated charts on the heavens; outlines the shapes and names them. Plastic and metal with optical lenses. 2 1/2" x 3 1/2". \$1.98 ppd. Elron Prod., 225 W. Erie Street, Chicago 10, Ill.



COFFEE LOVERS have raved for years about the brew served at New York's Sea Fare Restaurants. The firm has now packaged its private blend of Central and South American beans in regular and drip grind. Tins are designed with Greenwich Village scenes. 1 lb. \$1.25; 2 lbs. \$2.40; 3 lbs. \$3.50 ppd. Sea Fare Restaurants, 1033 First Ave., New York 22, N. Y.



GOOD TIES are welcomed by any man. These of pure silk, with a handsome embroidered monogram, are sure to please the most discriminating male. Rich fall and winter shades of navy, maroon, charcoal gray, silver gray, black, charcoal brown, medium brown—with 2 or 3 initials in contrasting silk. \$4.95 ppd. Tie-Of-The-Month Club, Dept. E, 520 Fifth Ave., New York 17.

You've ample time to order for Christmas from these pages and avoid crowds. But act promptly.

duncraft's all new FLIGHT DECK®

lures WILD BIRDS to your window • a thrilling gift!

Clip Flight Deck to your window and discover the sheer joy of attracting beautiful wild birds. Feed them, photograph them, watch them bathe just inches away, without going outdoors! Shut-ins, camera fans, youngsters, everyone becomes an armchair bird watcher and thrills to the close-up activity and charm of wild birds. New Flight Deck is a large 17 1/4" x 15 1/4", custom-molded of all-weather duralon. Green with white trim, it has hardwood perch rails and feeding stick, 4 seed wells, drinking and bird bath pool. Attach or detach INSTANTLY without tools. Gift packaged with card. All orders acknowledged. WE PAY POSTAGE, both on your order and Flight Deck gifts sent to friends. Money back guarantee.

duncraft • Dept. E-2 • Dunn Bldg., Penacook, New Hampshire

\$795 ppd.
2 for 1495

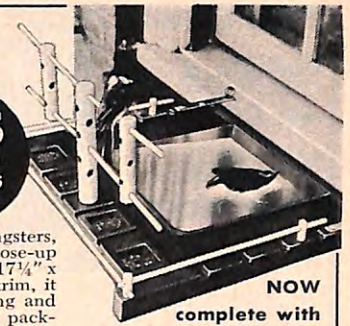

NOW complete with BIRD BATH POOL

Recommended & approved by National Audubon Society.

100x Area Magnifying Projector



JOHNSON SMITH CO., Dept. 508, Detroit 7, Mich.

New Midget Pocket Size Radio

\$2.98



Listen at work, play, in bed. Fits shirt pocket. No tubes. No batteries. No electric plug-ins. No expense. Plays day & night forever. New self-powered diode replaces tube. Red plastic case only 3 x 3 1/4 x 1 1/2 inches. Complete broadcast band. Ready to use; no building. Short aerial used for local stations. Radio (without phone) \$2.98. Hearing Aid Phone (Plugs in ear, flesh-colored, almost invisible) \$1.98. Regular phone \$1.25.

JOHNSON SMITH CO., Dept. 508, Detroit 7, Mich.

Catalog of 3100 Novelties



Novelties, tricks, jokes, gifts, gadgets, funmakers, hobbies, sports, games, etc. Big catalog 10c.

JOHNSON SMITH & CO., Dept. 508, Detroit 7, Mich.

The TIE of the MONTH CLUB

the male
SOLVES HALF OF YOUR GIFT PROBLEMS!
Solve your male gift dilemma all year round! Each month, Tie-of-the-Month fashion specialists scour the world's markets for outstanding ties. Original designs in fabrics imported from France and Italy include silks, jacquards, woven patterns, stripes. Each handsomely gift boxed free. Give "him" the gift that keeps on giving—a subscription to Tie-of-the-Month Club!
Only \$6.00 for 3 months, \$11.00 for 6 months and \$20.00 for 12 months.
INTRODUCTORY LIMITED SAMPLE OFFER
Send \$1.00 for proof of our outstanding values. You must be delighted with your tie or your money will be refunded.

TIE OF THE MONTH CLUB
Dept. E-12 520 Fifth Ave., New York 36, N. Y.

Day or Night ENJOY SOUNDER SLEEP with the Original SLEEP SHADE



No matter what the hour, you sleep in midnight darkness with your amazingly comfortable Sleep Shade. Resting gently on temple and cheek bones, it completely excludes light. Helps to rest tired eyes, soothe nerves and shield nasal sinus. Weighs less than an ounce!

Sleep Shade is scientifically designed with just enough stiffness to permit eyes to blink freely and to prevent harmful pressure on eyeballs. Only Sleep Shade has the patented, adjustable fastening that slips over and under ears to hold shade in place without slipping, pulling or pressure. Over 1,500,000 sold to satisfied users. Price of black sateen Sleep Shade only \$1.25.

Banish disturbing noises with Sleepwell Ear Stops. Soft and sanitary, they fit comfortably into ear openings and can be re-used many times. Only 25 cents a pair. Five pairs for \$1.00.

Both Sleep Shades and Sleepwell Ear Stops are available at Drug and Department Stores . . . or order direct from:

Sleep Shade Company, Dept. E-36
828 Mission St., P.O. Box 968, San Francisco, Calif.
(Postage prepaid if payment sent with order).
Full refund if you are not completely satisfied.



Marriage or Angel Medals

Precious way to say "I love you." Recalls moments to years of wedded bliss. Perfect memento for "Her" bracelet, or "His" key chain.

In Sterling Silver OR Gold Filled
3/4" dia. \$3, 1" \$4, 1-1/4" \$5, 1-1/2" \$7
In 14 Kt. Gold
3/4" dia. \$12, 1" \$15, 1-1/4" \$30, 1-1/2" \$40

Specify style medal desired, full name and number of years married. Prices include engraving, tax and postage. 1 week delivery.

Wayne Silversmiths 546C So. Broadway, Yonkers 5, N. Y.

Unusual! PRACTICAL GIFT! THE adjustable

Appreciated by beginners, regular players or experts. It's so easy and thrifty to play a game with just this one club! The head adjusts to each position from Driving to Putting . . . so, it's all you need. Ideal for traveling, vacationing and guest club. Thousands now enjoy and play better golf . . . and we guarantee, you too, will be pleased or your money back! Try it!

36" Short 37" Medium 38" Long (Specify length)
Send check or money order (we pay postage) or C.O.D. (plus postage)

Left Hand Model \$29.95 Right Hand Model \$24.95

INTERNATIONAL GOLF PRODUCTS
304 Oakbrook Road Hinsdale, Ill.



**PINE CONES
BLAZE
with COLOR . .
MAKE
FIREPLACES
MERRY**



Our beribboned basket of pine cones add dancing color and charm to your fireplace. Each cone, chemically treated, burns with brilliant long-lasting multi-colored flames. The imported fireside basket of split bamboo is 9" high and comes with approximately 40 pinon cones. Can be used as handsome wastebasket after cones are gone. Complete, \$3.95 postpaid.

ARTISAN GALLERIES 2100-Q12 N. Haskell, DALLAS, TEXAS

CUCKOO CLOCK



from GERMAN BLACK FOREST

Now \$3.95 only

postpaid . . . duty-free

Direct to you from EUROPE

Low price only by direct import. German weight and pendulum CUCKOO CLOCK.

Excellent timekeeper. Cuckoos every quarter hour. HAND CARVED. Antique waltz finish. Shipped direct from Free Europe with strange foreign stamps. Order as gifts, too. (Not more than one addressed to the same person.) Send only \$3.95 each. No COD's. Postman collects 15c foreign packet fee which can't be prepaid. Money-back guarantee. Order today.

SEVEN SEAS IMPORTS, Dept. F39C

1717 Westwood Blvd., Los Angeles 24, California



**YOU asked
for it —
and here it is**

In 1953 the Grand Lodge appointed The Elks Magazine sales agent for a line of specially designed official Elk emblem pins. The pins are all 10k gold with gold plated post and attaching button. All are beautiful examples of jeweler's art, brilliantly enameled red, white and blue.

Our advertisements about these pins in The Elks Magazine has resulted in much correspondence among which have been many requests for a lay membership pin less expensive than the 10k solid gold pin.

We have arranged with the manufacturer to provide such a pin in 10k, 1/10 single rolled gold plate to sell for \$4.00 including federal tax. It is identical in design to the pin which sells for \$7.35. For the many who have asked here is the answer. When ordering attach your remittance for \$4.00. For N.Y.C. deliveries please add 11¢.

THE ELKS MAGAZINE

386 Fourth Avenue, New York 16, N. Y.

Elks FAMILY SHOPPER



COCOANUT MACARUMS. These tasty, toasted macaroons have an added attraction: They're laced with West Indian rum to make a succulent morsel sure to please your palate. Packed in tins to preserve the rum flavor, they'll last and last, even after opening. 1 lb. Gift Tin, \$1.85 ppd. A. L. Roth Macaroon Bake Shop, Dept. E. 2627 Boardwalk, Atlantic City, N. J.



FOR AN EXECUTIVE'S DESK there's nothing smarter than this Golden Eagle Paper Weight and Magnifying Glass. The glass magnifies three times, swivels out for reading those speck-sized telephone numbers, examining stamps, etc. Jeweler gold finish on metal. 3" glass. Gift boxed. \$3.98 ppd. Mastercraft, 212K Summer, Boston, Mass.



ELEVEN USEFUL TOOLS. Fitted into a genuine stag handle are: 3 1/2" knife blade, stainless steel fork and spoon, reamer, corkscrew, scissors, file, awl, saw, carving blade, can and bottle opener. 4 1/2" long, closed. Comes in real leather holster with belt lock and ring for hanging. \$3.95 ppd. Scott-Mitchell House, Inc., Dept. K-51, 611 Broadway, New York 12, N. Y.



PARTY PICKS. Serve these smooth plastic picks for spearing hors d'oeuvres, relishes, small fruits. Washable and re-usable, they're topped with amusing little figures, a gay addition to fall parties. Big assortment in 4 colors comes in hinged plastic box. \$1.49 ppd. Mrs. Dorothy Damar, 720 Damar Bldg., Elizabeth, N. J.

**ACE
LATHER
SPREADER**

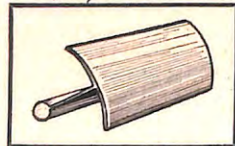

Send \$1.00 ppd. to

LANE SALES CO., Box 1059, Rocky Mount, N. C.

Attractive gold anodized metal for applying instant or push-button shave creams. Spreads thin and massages in, softening the beard at skin surface with possible saving of more than half the lather of that wasted by the messy finger application. A small deposit on wet surface of spreader goes a long way. Neat, quick and a pleasure to use. Appropriate gift for men.

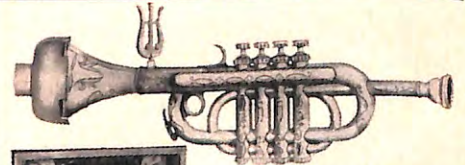

**educational! fun!
easy to play!
8-NOTE TOY TRUMPET**

Most sensible way to introduce music to your child . . . give this beautifully engraved, professional-looking, goldplated trumpet! Book of 40 easy-to-play songs, removable, washable mouth-pieces, and smart luggage-type carrying case all included. A full 16" long. For boys and girls of all ages. \$3.98 ppd. Sorry, no C.O.D.'s

BROWN & KANE 800 Broad St., Dept. A-1, NEWARK, N.J.

Elks Lodge Ring



Your price including all taxes.....

\$58.61 (same ring less diamond 28.44)

Send check or money order, no c.o.d.

Satisfaction guaranteed or money refunded.

MALCO Inc.

319 Madrona Av. Chula Vista, Calif. Specializing in fraternal rings and emblems



Musical Dolly Rocker. Delightful lullabies of built-in music box soothe dolly and "mummy" in this old time New England Dolly Rocker sturdily made of native hardwood and genuine plywood panels. Lovely natural blonde finish. Roomy 21" x 13" x 12 1/2", complete with bright reversible quilted plastic mattress. A gift with real old fashioned Christmas joy! Only \$9.98 ppd. (Please add 50¢ W. of Miss. R.) Money back if not "Pinked Pink".

PUDDIN' HOLLER, Box 622, East Swanzy, New Hampshire.

NEWS of the LODGES



John L. Walker, the Order's 1955-56 leader, is pictured, center, with E.R. F. A. Leggett, second from left foreground, and P.E.R.'s of Kinston, N. C., Lodge, when that lodge dedicated its new home. They include John Harvey, Thomas Hewitt, L. L. Mallard, George T. Skinner and Wm. F. Stanley, foreground, and H. P. Rasberry, Lloyd B. Humphrey, E. R. Wooten, Jr., W. C. Boone, E. I. Langrall and E. L. Scott, background.

Quincy, Mass., Elks' Youth Club Hears Forceful Address

Quincy Lodge No. 943 has organized a Youth Club which had Police Chief William Ferrazzi as guest speaker at its organizational meeting. Hitting hard against the coddling of juvenile delinquents, Chief Ferrazzi asked "their own generation" to expose these offenders. In forceful and derogatory terms he characterized young criminals vicious and cowardly troublemakers. He appealed to the Youth Club members to band together as a constructive influence, taking every opportunity to humiliate and disparage the hoodlum element in the community.

The club is composed of high school students within lodge jurisdiction, and the Quincy Elks' home is the scene of its weekly meetings. It has elected its own staff of officers from among its membership with Mary L. Nason as President and Atty. Joseph P. McDonough of Quincy Lodge as adviser.

Visits to Umatilla Home Popular Among Florida Elks

A group of 37 members of Stuart-Jensen Lodge No. 1870, led by E.R. Linwood I. Simmons, recently made a 200-mile bus trip to visit the Harry-Anna Home for Crippled Children at Umatilla.

On their arrival at the institution, which is sponsored and maintained by the Florida Elks, they were welcomed by Grand Trustee William A. Wall and State Assn. Secy. James J. Fernandez.

So successful was the trip, whose purpose was to better acquaint the membership with the splendid work being accomplished at Umatilla, that another visit was made in October.

Another group of Florida Elks to visit Umatilla was composed of 31 members of Vero Beach Lodge No. 1774, led by E.R. C. T. Walker and laden with gifts and treats for the Home's 70 young residents.

(Lodge News continued on page 40)

CORRECTION

We regret that in our listing of the 1956-57 Grand Lodge Officers and Committeemen which appears in our November issue, the name of the Grand Tiler was omitted.

As published in our Grand Lodge Convention report in August, the new Grand Tiler is John P. Martin, Jr., of San Pedro, Calif., Lodge No. 966, 979 Eighth Street.

Wisconsin Elks Assn. Pres. and Mrs. Arno J. Miller, right, and Grand Lodge Activities Coordinator and Mrs. Bert A. Thompson, second from right, are welcomed by E.R. and Mrs. Sherman Golden, left, and General Chairman Dr. M. J. Junion, third from left, on their arrival at Green Bay for the Assn.'s Fall Conference.



Standing in the third row behind the 14-man Grand Exalted Ruler's Class they initiated are Eustis, Fla., Lodge's Organist Fred Koss, Chaplain Harry Matthews, Est. Loyal Knight Art Hampy, E.R. John M. Kennedy, Lead Knight Fred Belton, Lect. Knight E. E. Phinney, Secy. P. H. Hethcox, Tiler Bo Smith and Esq. Robert J. Koss. Among the candidates was the son of Eustis Mayor Frank W. Stebbins.



Pres. A. Lewis Heisey of the Pennsylvania Elks Assn., second from right, foreground, congratulates Larry DiGiacinto and Miss Carol L. Hite on their receipt of \$400 Elk scholarships at a Middletown Lodge ceremony. Miss Hite received an Elks National Foundation award, while Mr. DiGiacinto's scholarship was given under the Student Assistance Program of the State Assn. and the So. Cent. Dist. Middletown Lodge officers look on.

ROD & GUN

BY DAN HOLLAND

As a quail hunter, Dan isn't much of a horseman—so he likes a jeep.



THE bobwhite quail is in all respects one of the finest of game birds. He handles well to a pointing dog; he has speed, maneuverability and a fast get-away; and he doesn't come easy. If a man

intends to bring some home, he has to get out and hunt, and hunt hard. He has to cover ground.

The optimum population for bobwhite, they tell me, is one bird to the acre. With a minimum of vermin and a maximum of both food and cover, this is the saturation point. In other words, it would require about twenty acres of range to support one covey if conditions were ideal—which they likely never are.

This bit of information accounts for several phenomena I experience at the end of a day of bird hunting: why there are holes in the heels of my socks, why I can trip on a spider web strung across the path, and why once I sit down, I find it almost impossible to get up again. There have been days when I have walked from dawn till dusk and apparently never beat my way out of the first acre. At least I failed to fly the first bird. And on those days I am just as tired as though I had gone to all the effort of shooting a limit. Yet the next day I work the kinks out of the old legs and hopefully walk another four hundred miles, more or less.

Hunters who recognize this fact—that a man has to put a lot of distance behind him to get quail shooting—have used their heads instead of their legs to solve the problem. Some of them have come up with a better means than mine of getting

to the birds. On occasion I have hunted with several such men, and the purpose of this article is to describe their hunting rigs for the education and envy of other leg hunters like myself.

The original leg saver—and still the most versatile in the hunting field—is the horse. The hunting horse is still used quite extensively in some parts of the South and is considered a luxurious means of bird hunting. I have my own personal opinion about this. About the nineteenth time I climb up into the saddle, I conclude it would have been easier to have walked. Also, for the wear and tear a horse saves on one part of my anatomy, it makes up for on another part—and I do like to sit down at the end of the day. But my grievances aren't shared by quail hunters in general. Those who know and use horses say there is no finer way of bird hunting.

The country cousin of the horse, the mule, being more passive, is used in some sections, although I am told that a horse which has been broken to hunting is preferable. Some horses are so tractable that they will even permit a hunter to shoot from the saddle. This is something I have

never tried, nor do I intend to. I have troubles enough on horseback without shooting a twelve-gauge shotgun between the ears of one of the critters. I can picture myself, as a result, draped over the bottom branch of a long-leaf pine.

Horses or any other leg-saving hunting rigs presuppose the use of fast dogs capable of covering all the ground ahead of the riding hunters. I have shot numerous quail while propelled only by my own two feet and without the use of any dog whatsoever, which is a sign of two things: one, that I like to hunt; and, two, that I lack good sense. Bobwhite range over such a wide area that the use of a bird dog is all but essential; and, for good results, the dog—or dogs—should be fast, keen-nosed and steady.

Since a quail dog must cover so much ground and since it is often warm in bobwhite country, a dog should not be left down more than a half-day even while foot hunting. In horse-back hunting, the dog—or brace—should be rested more often. This presents a problem. The hunt must be arranged to return to the base of

(Continued on page 43)

Photos by Dan Holland



Quail hunting rig of Ed Inglis is built on a pickup truck. The hunting jeep has rear platform and gun rack to the right.

FOR

The Height of Elegance

IN HOLIDAY GIFTS... GIVE

Schenley

It's America's most wanted gift whiskey — clearly finer Schenley Reserve in the towering "Skyline" decanter. Here is a gift every man on your list will welcome warmly! Comes pre-wrapped in a handsome holiday gift box, at the same price as the regular fifth.

"SKYLINE"
DECANTER

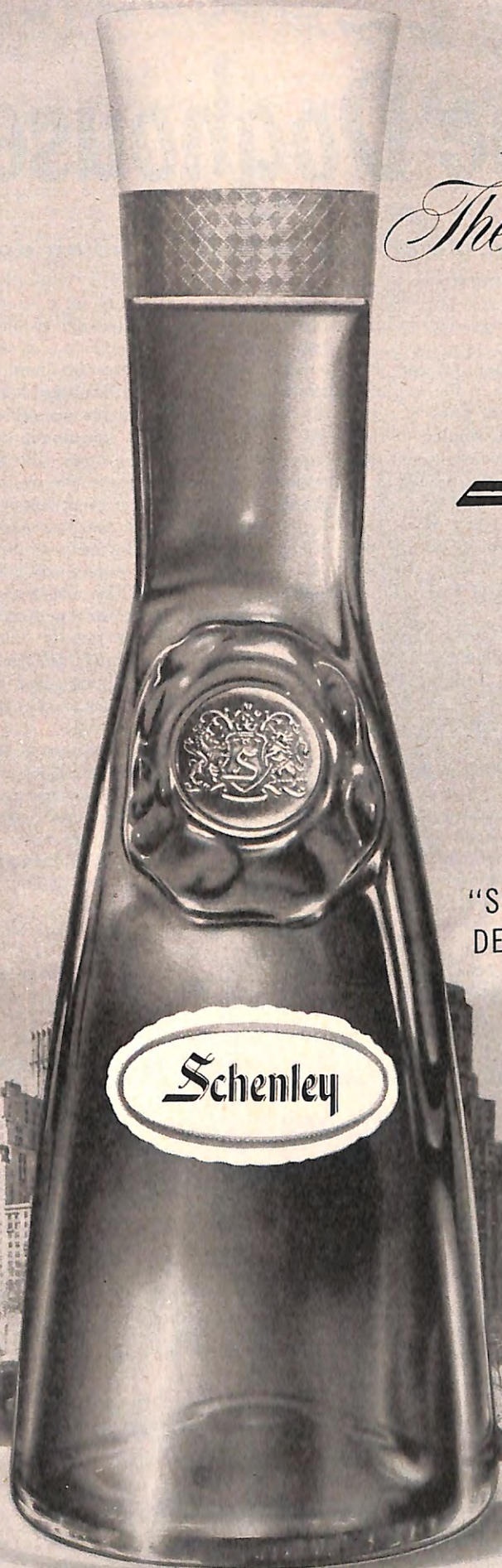

SCHENLEY DISTILLERS CO., N. Y. C. BLENDED WHISKEY, 86 PROOF. 65% GRAIN NEUTRAL SPIRITS.

with Ed Faust



In the Doghouse

Faust offers some minor first-aid for the ailing dog.

SOME OF THE CUSTOMERS (another way of saying indulgent readers) who are either new to dog owning, or if accustomed to this amiable practice and to the equally amiable habit of reading these articles, seemingly are not aware that only for the most simple, easily discernible ailments that afflict the pooch do I attempt to offer, by mail or otherwise, medical advice. At such time I always add a cautionary warning to have the dog taken as soon as possible to a veterinarian, preferably a small animal vet.

The reason for the latter advice is that in remote communities that have the benefits of such medical service the vets are likely to be more experienced with larger animals of the farm than with dogs, which have some sicknesses peculiar to themselves. The reason I decline to give advice in matters that seem serious is simple—I'm not a veterinarian, and in simple justice to the dog and its owner I tell owners to get the first-hand opinion of one who is licensed to doctor sick animals.

I have no patience with those who would attempt to prescribe for an animal by mail. Too often the owner is not able to describe the dogs' symptoms fully and accurately and, in view of this, how anyone can be brash enough to advise about a sick dog under such circumstances is a mystery I know I'll never solve.

Now in the light of this, what follows may seem contradictory because it's going to tell what to do when an emergency arises that finds Fido in the middle. What to do when the dog gets hurt and until he can be given the services of skilled medical or surgical attention. Some few of the accidents dogs encounter can be treated at home, but bear in mind that for most dog injuries veterinarian service is a must. Yes, I'll even say for minor injuries that you can attend to, it is best to have your vet check what you have done.

In addition to the pain of an injury there is more often a lack of understanding on the part of the dog as to what caused it and this of course frightens him. Even without injury, a frightened dog is difficult to handle, and frequently dangerous. If the dog is not too big and can be cornered, a blanket can be thrown over him and this will help in putting a muzzle on him. An injured dog is likely to snap and bite even the best of masters. The blanket business is really a two-person

job, particularly if the dog is on the large side.

For the really big dog that can still move around, a loop snare at the end of a pole or other large piece of wood is about the only method you can employ to capture him. If you lack a conventional dog muzzle, you can make one by using a long strip of cloth or a piece of rope, wrapping this around the dog's jaws and tying it underneath the lower jaw. After this is done, bring the two ends up behind the dog's ears and tie them there.

TRY TO keep fear or alarm out of your voice and at no time should an injured dog be handled roughly. Either will only add to his fright and dispel his confidence in you. If the injury is an open wound and the bleeding is not too profuse, a simple bandage of a few strips of clean cloth will usually check it. You might use the regular packaged bandage (always good to have around the house in several widths) or a clean, large handkerchief. But the bandage of whatever material,

should be tied tight enough so the dog cannot "worry" it off.

If bleeding is severe this may mean that a vein or an artery has been damaged. If it is a leg wound, or on any other part of the body where a tourniquet can be applied, this should be done. The tourniquet should be tied above the wound. A handkerchief, a rope or your belt will do with a stick inserted to serve as a lever to tighten that part of the body by twisting the stick in the tourniquet until bleeding is checked or fully stopped. The pressure should not be continuous. Never should the tourniquet remain taut for more than 10 minutes. If the wound is only superficial let it bleed for a while, as the bleeding will help wash out any germs.

When bleeding stops the wound should be bathed with clean, warm water and sterilization treatment be given. For cleansing use a wash of boric acid—a teaspoonful to a half glass of water. Follow this by swabbing with iodine, creolin or a weak solution of lysol. Better still,

New York Daily News photo

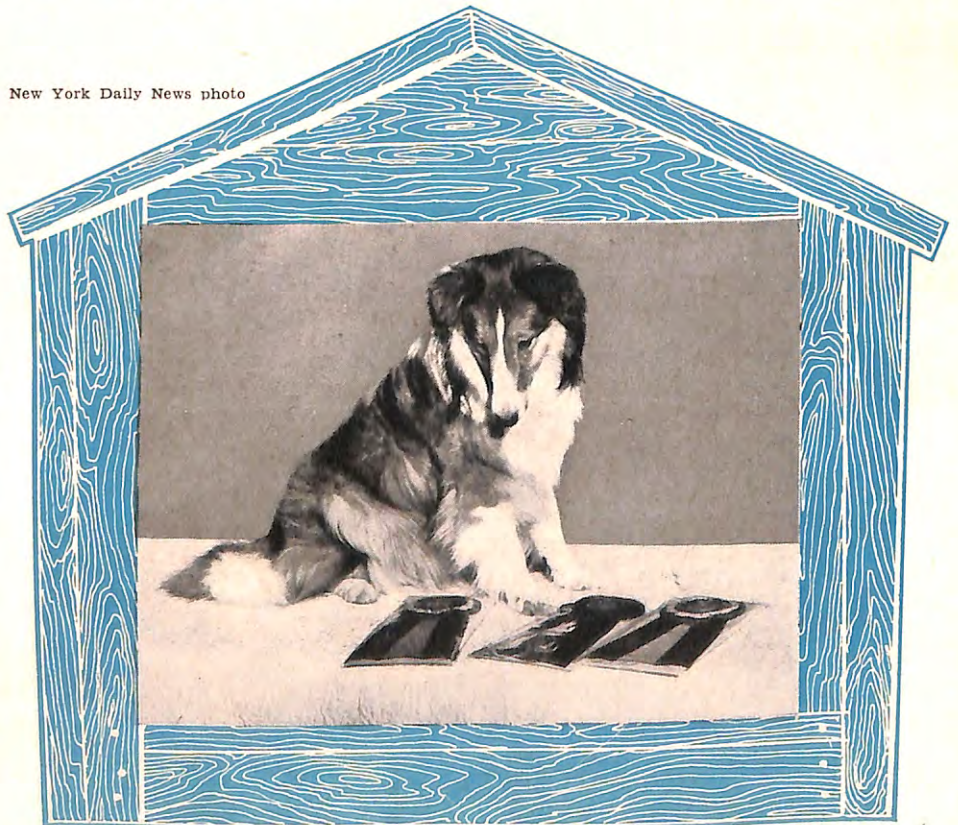

Emerald's Nina O'Cherrilon, Shetland sheepdog, admires her ribbons.

follow your bandaging and cleansing by taking the dog to a vet. To help stop moderate bleeding, powdered alum or tannic acid are useful.

Handling of a burn in emergency treatment differs from that applied to a wound or cut. Burns should not be washed with water. A soothing oil, olive, cottonseed or mineral if nothing else is available, should be applied. A mixture of linseed oil and lime water is an excellent dressing, and a beaten egg added to this is better. This should be mixed in equal parts and applied gently. Following this a pad should be soaked in the mixture and bound to the burned area. Another good healing agent is a solution of one hundred parts of water to one part of picric acid. Your local druggist can prepare this for you. Here again, you begin with muzzling the dog and end by taking it to a vet. The treatment I've outlined is for emergency only. Don't indulge in the mistaken kindness of trying to save the life of a badly burned animal. If necessary and advised by the vet, have the dog put out of this world. Your vet can do this in a way that works almost instantly and with no pain to the dog.

USUALLY it is accidental when a dog is poisoned, because some dogs will eat almost anything. Sometimes the poisoning is the work of a sadistically minded human being, and that is one of the best of all reasons why a dog should not be permitted to roam freely. Properly confined to his own home, he'll get the kind of food you choose for him and is far less likely to be exposed to the dog poisoner. But even at home Fido does sometimes get poisoned. He may lick fresh paint, and certain antiseptics, household cleansing fluids and powders are highly dangerous.

If the poisoning is detected quickly enough, the first thing is to get the dog to empty its stomach before the poison works into the blood stream. With some of the poisons which are rapid in their effects this may not be possible. But if time permits there are any one of several emetics that can be employed. A teaspoonful of washing soda in a half pint of warm water should be poured down the dog's throat—slowly poured so he can absorb it. But be *sure* this is washing soda and not one of the household bleaching fluids.

A mixture of mustard and warm water in proportions given here, or even plain table salt or the unbeaten whites of two eggs, should help in the business of getting the dog's stomach cleansed. It is important to know what it was that poisoned the dog and immediately after the home treatment it should be taken to a vet for examination and further treatment, should such treatment be necessary. Symptoms of poisoning are violent retching, emptying of stomach with greenish or bloody content, inordinate thirst, twitching, trembling, yelping or extreme tenderness and sensitivity to touch around sides of body or stomach.

3 SECRETS OF COOLER SMOKING

WITH ANY PIPE

1. The Right Tobacco

Experts agree white burley is the finest, coolest smoking tobacco of all. For this reason, many pipe tobaccos contain burley. But not one in over 50 years has ever equalled Edgeworth's way with white burley. Edgeworth tobacco buyers look for a certain type of white burley, grown on well-drained land on sunny hillsides, just like fine wine grapes or fine coffee. Then, like fine wine, these special burleys are aged for years before blending.

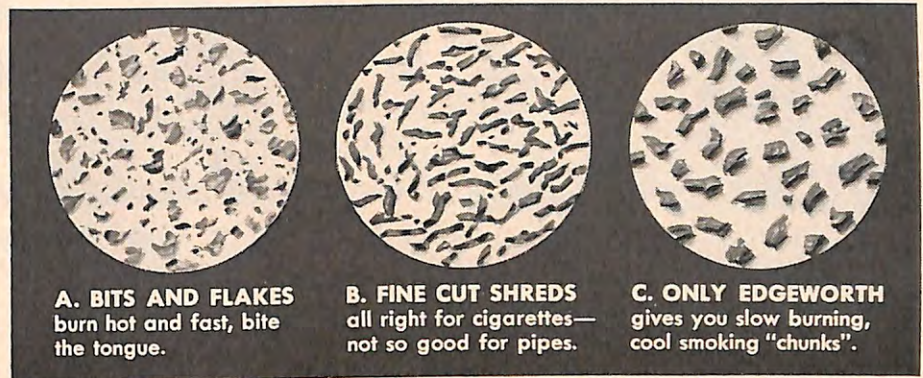

A. BITS AND FLAKES burn hot and fast, bite the tongue.

B. FINE CUT SHREDS all right for cigarettes—not so good for pipes.

C. ONLY EDGEWORTH gives you slow burning, cool smoking "chunks".

2. The Correct Cut

Many a smoker used to rub a slice of tobacco carefully between his palms, until it formed chunks of just the right size to pack right and smoke cool. Now Edgeworth does all this before the tobacco is packaged. No other tobacco manufacturer can duplicate the Edgeworth cut—because it's actually "ready-rubbed" by an exclusive process. See in the picture what a difference this makes. Edgeworth's even-sized chunks (Picture C) burn slow and cool with never a touch of tongue bite. No other tobacco is "ready-rubbed" like this. And tests show that Edgeworth smokes 8 to 10 degrees cooler than other tobaccos tested.



3. Factory Freshness

Edgeworth's exclusive wrap-around pouch is heat-sealed. Moisture can't get in—proof that freshness can't get out! And no bulky corners in your pocket. You can always count on Edgeworth, America's finest pipe tobacco for over 50 years.

LARUS & BROTHER CO., INC.
RICHMOND, VIRGINIA

AMERICA'S COOLEST SMOKE
(8 TO 10 DEGREES COOLER)



EDGEWORTH

AMERICA'S FINEST PIPE TOBACCO

NEWS of the LODGES

Right: When Leominster, Mass., Lodge started its campaign for funds to aid six-year-old Johnny Granata who had been struck down by a hit-and-run driver, they received the assistance of Fitchburg Elks who held their own house-to-house canvass which added \$746.78 to the ultimate \$10,000 fund. Pictured when the Fitchburg donation was made were, left to right, foreground, State Rep. J. Robert Mahan; Police Chief George H. Smith who accepted the check from former Mayor P. J. Levanti, P.E.R. of Fitchburg Lodge; Mayor L. J. Cormier, and Michael Pandiscio, Treas. of the Fitchburg Committee. In the background are Leominster Treas. Deane Foster, Fitchburg Committee Chairman Samuel Rizzo, P.E.R. Anthony Angelini of Leominster and Secy. Joseph Albert of Fitchburg.



Above: Bob Eberly, nationally known singer of popular songs, headlined the three-hour variety show sponsored by Quincy, Mass., Lodge to raise \$3,000 for ten-year-old Irene Sutherland, pictured, center, with her six-year-old sister Margaret. Irene, a cerebral-palsy victim since birth, was the beneficiary of the first in a series of special programs to be given annually by the lodge to assist afflicted persons.



Left: Donald G. Nantes, left, Pres. of the Pennsylvania N.W. Dist., presents a \$200 Corry, Pa., Elk scholarship and a \$400 State Assn. award to James Watson, in the presence of Miss Madeline Myers, another recipient of a \$200 Corry Elk award, and E.R. Olin W. Bracken.



Right: E.R. Roland J. Sell of Scottsdale, Pa., Lodge, left, congratulates Harold Davis, recipient of the lodge's \$100 Student Aid award, as P.E.R. Donald Laughrey, Fund Chairman, looks on.



Above: Richard M. Blake, left, E.R. of Springfield, N. J., Lodge, No. 2004, presents the new lodge's gift of a clock for the local First Aid Squad Home to John Baier, President of the Squad.



Left: Members of Arlington, Mass., Lodge man the refreshment table to dispense over 1,900 hot dogs to local children on the 1956 Annual Kiddies Day sponsored jointly by the Arlington Elks and the local Park Dept.



Above: When E.R. Edward G. Johnson of Ogdensburg, N. Y., Lodge, left, initiated his son Edward, Jr., center, State Assn. Pres. Francis P. Hart, right, was on hand to congratulate them.

Right: When D.D. Ned C. Cook visited the Elks of Bloomsburg, Pa., he was a witness to the presentation of a \$200 lodge scholarship to JoAnne Schneider, and a \$200 No. Cent. Dist. Elk scholarship to Alice Wirt. Pictured were, left to right, Mr. and Mrs. Gerard Schneider who accepted their daughter's award in her absence, E.R. G. W. Traub, D.D. Cook, P.D.D. Arthur Cox, lodge Secy., and Miss Wirt.



News of the State Associations

(Continued from page 24)

pionship to San Bernardino Lodge in Class A, although the Class B entry from Long Beach vanquished the Alhambra contingent. The team from Long Beach also won the softball contest.

Many fine social activities were enjoyed by the delegates and their guests, with the second day highlighted by the Annual Memorial Service, handled by Past Pres. Mohrbacker with Past President J. Thomas Crowe delivering an eloquent address.

Serving the Association until the 1957 conclave in Santa Barbara are Pres. Owen Keown, Santa Monica; Vice-Presidents Leslie Whealy, Ontario; Frank Bowdern, Escondido; John Cabot, Pasadena; Leroy Koos, Culver City; Curtis Clark, Los Gatos; George Godfrey, Visalia; Frank Luttig, Sacramento; Granville Burke, Oakland; Otto Recknagel, Vallejo, and Harold Clarke, Redding; Treas. Robert Walker, Santa Ana; Secy. (17th year) Edgar W. Dale, Richmond; Chaplain Rt. Rev. Msgr. George Scott, San Pedro; Sgt.-at-Arms John Shea, Santa Ana; Asst. Sgt.-at-Arms Lloyd Stolich, Salinas; Tiler Stanley Stebbins, San Francisco; Asst. Tiler Monte Pearson, Madera, and Trustees Kenneth Husby, Banning-Beaumont; George Stephenson, San Pedro; Charles Kaiser, Coalinga; John Kenward, Marysville; Henry Budde, San Francisco, and Paul Wemple, Susanville.

GRAND EXALTED RULER BOHN ADDRESSES COLORADO ELKS

Grand Exalted Ruler Fred L. Bohn was the principal speaker at the opening session of the Colorado Elks Assn. on Sept. 20th, stressing a new and positive approach to the national problems of juvenile delinquency. "I have no use for the term 'juvenile delinquency,'" he stated. "Rather we should encourage examples of 'juvenile decency'."

A total of 1,220 Elks from 39 Colorado cities and from 17 States and foreign countries attended the three-day conclave at Loveland, at which Salida Lodge's team became State Ritualistic Champion. Robert J. Barth of Brighton succeeds Donald Johnson as President of this organization. Other officers elected at this time were Byron Anderson, Denver, 1st Vice-Pres.; Dr. Leo Schneider, Craig, 2nd Vice-Pres., and Frank Buskirk of Montrose and Eugene Welch of Grand Junction were reelected Secy. and Treas., respectively. Warren K. Phillips of Pueblo is Sgt.-at-Arms; C. B. Millen, Brighton, Chaplain, and Joseph Thomas, Central City, Tiler.

During this Convention, it was reported that the Colorado Elks had given a total of \$39,930.43 during the year to Elks Laradon Hall, the school for exceptional children which has been the Association's main project since 1950.

There's nothing to compare with
MELROSE
RARE
Beautiful GIFT DECANTER

A whiskey of Rare quality.
A Decanter of rare beauty... in a gift box that proudly says: "The very best"... at no extra charge.

"My master gives Melrose"

BLENDING WHISKEY, 86.8 AND 90 PROOF, 40% STRAIGHT WHISKIES 7 YEARS OLD, 60% GRAIN NEUTRAL SPIRITS, MELROSE DISTILLERS CO., N. Y.

Since 1926! The Halvorfold

Loose-leaf Pass Case, Billfold, Card Case. Note exclusive features. Read Special Offer below

Billfold
Card Pocket
Card Pocket
Your name, address etc. in 23K Gold FREE.
Exclusive Loose-leaf Device
8-pass capacity replaceable
\$5.00 Black or brown Morocco
\$7.50 Smooth black or brown Calfskin
Now with or without emboss. ELK emblem outside front
Gold Filled Snap and Corners \$1.00 extra

"Made to Order" for ELKS

Free Examination!
Send No Money—Pay No C.O.D.

NOW in its 30th year—The HALVORFOLD bill-fold, pass-case, card-case. Just what every Elk needs. No fumbling for your passes. Unsnap Halvorfold, and each pass shows under separate, transparent face, protected from dirt and wear. Ingenious loose-leaf device shows 8, 12 or 16 membership cards, photos, etc. Also has three card pockets and extra size bill compartment at back. Made of the Finest, Genuine Leathers (see above) specially tanned for Halvorfold. Tough, durable and has that beautiful, soft texture that shows real quality. All nylon stitched, extra heavy. Just the right size for hip pocket. Backbone of loose-leaf device prevents breaking down. You can't wear out the leather body of Halvorfold.

Means exactly what it says. No strings. Mail coupon. Halvorfold comes by return mail. Examine it carefully. Slip in passes and cards. See how handy it is. Show it to your friends and note their admiration. Compare it with other cases at more money. I trust Elks and all the Mrs. Elks, who buy annually, as square-shooters. And I am so sure the Halvorfold is just what you need that I am making you the fairest offer I know how. Send coupon NOW. Avoid last minute rush!

FREE in 23K Gold, Name, Address and any Emblem. Would ordinarily cost \$2.50 extra. Ideal Gift with friend's name and any fraternal emblem.

HALVORSEN, P.C.M.—Station G—Jacksonville, Fla., Dept. 79

Send HALVORFOLDS for free examination as per instructions below. If I decide to keep them, I will send check at once. If not, I will return merchandise in three (3) days and call the deal closed. (HALVORFOLD comes regularly for 8 passes. For 12-pass add 25c, 16-pass 50c, etc.) Please check squares at right and below. Also "PELVY" 23K gold engraving instructions to avoid mistakes. Do you want the ELK emblem embossed on the outside? Yes No.

PLEASE CHECK HERE:
 Black Brown Calfskin
 Black Brown Morocco
 Gold Filled Snap & Corners (\$1.50 extra)
 8-pass 12-p. 16-p.

Name..... 23K Gold Inside Emblem:

Address..... Money back if not satisfied.

5% off to save bookkeeping, if you prefer to send cash with order.



TRAVELGUIDE

The 1957 Hawaiian Elks Post Convention Tour of the Islands is now the "Official Elks Tour of Hawaii." The Convention Committee of the Grand Lodge at Chicago last year authorized sanction of the Grand Lodge for the future post convention Hawaiian tours as the "Official" one. Plans are now under way for next year from San Francisco and as soon as we have a report from the Committee, which has had several meetings, we will publish more details.

★ ★ ★

The Congress of Motor Hotels' \$5,000 contest, which was announced in our October issue, has created quite a stir among our many traveling readers. After spending a night in one of the Congress Hotels, our readers report it quite easy to write, "Why I patronize Motor Hotels." First prize is a 1957 Dodge hardtop, second prize an RCA Victor color TV. When you are on the road, stop at a Congress

Motor Hotel and send in your official entry before January 31, 1957.

★ ★ ★

We have been sending out a number of official folders on the 1957 Post Convention Tour to Alaska, sponsored by the Elks Alaska Territorial Association. The tour will follow the San Francisco Convention in July next year, and, if you are interested, write us for a folder which gives detailed information.

★ ★ ★

Phoenix and the Valley of the Sun, where it's Indian Summer all winter, reports more than \$8,000,000 worth of new and refurbished accommodations for the travelers this season. More than a half dozen sleek new establishments offer a wider choice of accommodations and practically all the older resorts, hotels and motor courts, have been spruced up with new decorations, furnishings and facilities. Complete information from Vacation Advisor, Phoenix Chamber of Commerce, Phoenix, Arizona.

★ ★ ★

French Motels are new but are combining the assets of both the American and French ways of living. The Motel Cote d'Azur (Antibes) offers a full-scale swimming pool; the Motel de Louveciennes has auto-

matic washer facilities; the Motel's Basques (St. Jean de Luz) features four person units for only \$11.43 to \$17.14 and the Motel de Golf (Le Touquet) is next to tennis courts, golf course, the sea and less than a mile from the airport.

★ ★ ★

The Mid-South is preparing for its winter season with superb fishing, hunting, fairs and golf. October saw the opening of the resort hotels in Pinehurst and Southern Pines, North Carolina, and the Southern Pines Golf Club owned and operated by Elks invites all golfers to play the course—one of the finest in the country. You'll get a real Elks welcome—write us for a descriptive folder.

★ ★ ★

For those going to Alaska next summer there is a new, scenic highway into Mt. McKinley National Park to be opened in June, 1957. It will be the first time motorists will have been able to get into the park, hitherto available only by train.

★ ★ ★

A new low-cost de-luxe air service has been inaugurated by Cinta-Chilean Air Line between Miami and Santiago, Chile. Fare for the 8,000-mile round trip is \$349.20. Stop-overs are permitted at Panama and Lima, Peru.

For Elks Who Travel

(Continued from page 19)

A piano tinkles through dinner and the broil chef works behind a glass screen.

By day the shops along Kalakaua offer what to my mind is a unique selection of goods. For one thing, there is a tasteful selection of things up from Hong Kong culled and laid out in air-conditioned shops—hand-painted screens, bamboo handbags, and silks. For another, there are the goods of Japan—lacquered boxes and vases, delicate rice-paper lamps and Japanese cloisssoné. There are wood roses from Hawaii and aloha shirts and guava jelly made in the islands to remember them by when the jar shows up on your kitchen table at home.

But this is just Honolulu on the island of Oahu. There is still Maui and Kauai and the big island of Hawaii. The Big Island has black sand beaches and fern forests. It has a fertile fishing area off the Kona Coast, and most of all it has the great volcano of Mauna Loa which boils and bubbles periodically and spills hot lava down its sloping sides boiling water and fish at once. The 1950 eruption was the greatest since 1859, but the visitor will be able to trace lava outpourings both old and new all around the great cone. Up at the brink of Kilauea crater is Volcano House, a precariously positioned inn that has greeted everyone from Mark Twain to Franklin Roosevelt.

Maui and Kauai are more gentle islands where flowers grow and Hawaiians dance and life is about as strenuous as the

weather—almost a constant 73 degrees. The Hana Maui on Maui, built by Paul Fagan, a West Coast millionaire, is certainly one of the most beautiful spots in the Pacific, with its soft rolling grounds, its tropical trees and flowers, and above all its beautifully appointed cottages and rooms. Kauai is the greenest of the islands where the pineapple fields run out to the sea and the beaches rim the shore waiting for the tired traveler from the mainland. The Coca Palms Hotel makes a Herculean effort to reproduce the old Hawaiian ways. At night Hawaiians run about the grounds lighting the flaming torches. Drums beat and a boy with a conch shell stands on a wooden bridge and blows the call to dinner. There is hardly

Grand Secretary Receives Good Neighbor Award

At the Grand Aerie Convention in Pittsburgh last summer, Grand Secretary Lee A. Donaldson was presented with the Good Neighbor Award of the Fraternal Order of Eagles, the presentation being made by Past Grand Worthy President Maurice J. Splain. The award is in the form of a beautifully engraved plaque, which reads: "Fraternal Order of Eagles . . . International Good Neighbor Award . . . Presented to The Benevolent and Protective Order of Elks for your Order's Many Contributions to the Welfare of our Country and Its Citizens."

a hotel about making a more dramatic invitation to sit down and eat.

Travel from island to island can be done with dispatch on Hawaiian Airlines' Convairs. The distances are short. Kauai to Honolulu, for example, is forty-five minutes. As for getting back and forth to the West Coast, I must impress upon you—some of my friends feel Hawaii is on the other side of the world—that it is for those who want to fly, a simple flight, and a treat to consider for those Elks attending next summer's West Coast convention and the post-convention tour to Hawaii (See "Travelguide" on this page). If you want to sleep overnight, Pan American is still flying the wonderfully comfortable Boeings, but progress is unstoppable, and United has already brought its flight time down to where it is moving too fast to provide a whole night's sleep. Its DC-7s make the crossing in seven hours or so, sometimes a bit longer, but in any case scarcely time to get bedded down before you are there.

The leisurely way is by ship, a crossing which takes some four days. For those who have the time it is in good weather a vacation in itself. American President Lines on its Orient cruises stop for the day in Honolulu, and Matson Line makes a specialty of cruising out to Hawaii.

A taste of things to come was provided not long ago when de Havilland's improved Comet III made a jet run from Hawaii to Vancouver, British Columbia, in five and a half hours. It will be less than that to U. S. West Coast landing grounds, and by 1959 Waikiki will be merely a whoosh away.

"Journal" Article Pays Tribute to Elkdom

Under the heading "The Brothers", in its customary thorough coverage of important subjects, the "Wall Street Journal" recently ran an article about fraternal organizations which was written by staff reporter John S. Cooper. The Benevolent and Protective Order of Elks, of course, was included in the article, and particular reference was made to the never-forgotten contribution that the Elks made in 1906 at the time of the disaster in San Francisco following the earthquake when Grand Exalted Ruler Robert W. Brown went there immediately to super-

vide relief work that Elks were giving.

"The fraternal orders and service clubs, of course, are best known for their charitable works, which are of incredible size and diversity," wrote Mr. Cooper, continuing:

"The first provision wagons into San Francisco after the big earthquake and fire of 1906 were manned by Elks from Oakland, who in 12 hours set up a tented city and hospitals and were taking care of 2,000 homeless people. Nearly every major disaster from the Johnstown flood down to the present has been the occasion

for more aid from the Elks. Last year its lodges spent \$6,489,021 on various good works such as aid for needy families, crippled children and cerebral palsy victims."

This memorable work of the Order in its early days when it was less than a quarter of a million strong created a deep and lasting impression. We were reminded of this by Mrs. Gertrude Bamberger, who wrote to the Riverside, Calif., "Daily Enterprise" last spring and said that she was one of the refugees who was permitted to stay in the camp that the Elks set up in Oakland immediately after the earthquake. This letter of Mrs. Bamberger was used in our June issue as the basis of an editorial.

Rod and Gun

(Continued from page 36)

operations before the dogs are exhausted or to rendezvous along the way with a mule cart bringing a fresh brace.

A more modern rig—and one to which I adapt more readily than the horse—is the jeep.

A jeep isn't capable of traversing quite the variety of country that a horse can negotiate. It cannot make its way through a heavy stand of timber, for instance, which might be manipulated with ease by a horse and rider, but it can do well enough. It has a surprising range, and until a person has actually ridden one cross-country, he can't realize just how serviceable a jeep can be for quail hunting. There are thousands of acres of bird country in the flatlands of the South which fall easily within the capabilities of the jeep. Also, the jeep can carry considerably more than just its riders with no extra effort, including such important things as extra shells, lunch, and even a resting dog or two.

In jeep hunting, as in horse-back hunting, the dogs range ahead while the vehicle follows slowly along. When a covey is located, the hunters pile out of the jeep, load up and walk to the point. The singles are followed on foot, then the dogs and jeep take off in search of another covey of quail.

A man I jeep-hunted with for several days in Georgia had added a couple of accessories worth noting. One of these is a foot-wide step or platform which he welded onto the frame at the rear end of the jeep. This permits a couple of hunters to ride on the rear, standing on the platform. Not only is this more convenient than climbing in and out of the jeep, but it puts the hunters in a position to see clearly on all sides and to keep a constant eye on the dogs working ahead and to the sides.

Another idea he incorporated on his hunting jeep is a two-gun rack mounted to the rear and right for the convenience of the hunters riding the platform. This leaves their hands free to hold on when the riding is rough, and it also holds the shotguns in a handy and safe position. He also added an extra-heavy front bump-

er to clear the way in thick going. Last, the hunting jeep should be equipped with a winch for emergencies.

But as satisfactory as such a jeep can be, it is merely a start in the right direction compared to the hunting rig belonging to Ed Inglis, of Miami, Florida. It is a pleasure to witness perfection in anything, and his rig is perfection. It is the ultimate for the foot-sore bird hunter.

Ed Inglis' hunting car is built on a pickup truck which has ample ground clearance. To increase the clearance and to give it footing where the going may be

a bit soft, it is fitted with oversized tires, as shown in the photograph. As a result, it can straddle and ride over a pine stump without a pause. Also, an extra low gear has been added to the transmission for difficult terrain.

On the body of the pickup are mounted two kennels, each capable of carrying four pointers. While one brace is in the field, the others are held here in reserve. Being a perfectionist, Ed Inglis has dogs which are not only fast, capable and stylish, but they are all one color: lemon and white. This is partly whim, of course. Color ob-

ALL THESE PRESENTS JUST FOR ME?

I LOVE YOU BOYS, REALLY! BUT...YOU SEE...

SMELLS GRAND!
PACKS RIGHT!
SMOKES SWEET!
CAN'T BITE!

A PIPE SMOKIN' MAN ALWAYS WINS WITH ME!

IT'S SIR WALTER RALEIGH - NATURALLY!

SIR WALTER RALEIGH'S BLEND OF CHOICE KENTUCKY BURLEYS IS EXTRA-AGED TO GUARD AGAINST TONGUE BITE. XMAS-WRAPPED ...IT MAKES A PERFECT GIFT.

It costs no more to smoke the best!

SIR WALTER RALEIGH
SMOKING TOBACCO
FOR PIPE AND CIGARETTES

viously doesn't have anything to do with a dog's hunting ability. But his insistence on only lemon-and-white pointers does have one practical aspect. When dogs range as fast and far as his do—often a half-mile ahead—the lighter they are in color, the more white they show, the easier they are to keep in sight.

With this same thought in mind, one of the finest features of his hunting rig is a seat mounted topsides, to the rear and above the cab. From this high vantage point, there is little chance of losing track of a wide-going dog. Since there is considerable toss to such a high seat, a heavy grill erected in front of the seat acts as a sturdy foot brace, and there are hand grasps on either side. This top-side seat, which has sponge-rubber bottom and back,

folds down out of the way when not in use.

Over the kennels at the rear are compartmented spaces for shells, jackets, and the like, and sheepskin-lined gun racks. Other refinements are: a tank of water, permitting watering hot and thirsty dogs regardless of local conditions; a small ice box for carrying a cool lunch, and drinking water; a folding table and chairs for a comfortable lunch and mid-day break under the shade of some live-oak trees. In fact, about the only thing Ed Inglis' rig doesn't carry with it is a covey of birds, but his pointers experience little difficulty finding and holding these, and he can hit them. That about completes the picture.

I have never hunted in such style and seldom have witnessed such dog work or experienced such quail shooting as the

time I hunted with Ed Inglis and his rig among the open piney woods of west Florida. That was several years ago, and since then I have reverted to type. I'm cut out to be a foot-slogger. I admit that I wouldn't walk two city blocks to a grocery store unless I was practically starving, but it is amazing the miles I can get out of my legs when I'm carrying a shotgun.

And we long-legged hunters do have a certain advantage over those who hunt in style. We can kick out the briars and tangles and occasionally walk into a covey that somehow the dog has missed. That's a bonus in the way of a hunting thrill that the man on a horse, jeep or swamp buggy will never know—and likely will never regret either.

One For the Money

(Continued from page 5)

believe. I'll be there as soon as I get my car out of the garage."

She started to say something else, but he refused to let her continue. Police, he kept repeating: Get the police. He replaced the telephone and reached for his coat.

He'd never heard Ann so jittery. She was a professional nurse. She'd always seemed to take things in stride. But if she was alone in the house on Fairhill Drive with the murdered body of her patient . . . well, that was more than enough to upset anyone.

Dave lived only a few blocks away. He donned his coat, turned out the lights and went down to the line of garages in the rear of the apartment house. He backed out of the garage, hoping that Ann had already called the police.

Half a block away from Stewart Waring's home, Dave realized that Ann had followed instructions. In front he saw two black and white patrol cars and an ordinary sedan which he figured was a detective car. They sure worked fast. The lights blazed in the house, neighbors stood on the sidewalks, held in check by a couple of uniformed men.

Dave parked across the street. As always, he was impressed by the unimpressiveness of Stewart Waring's house. It was a one-story affair, architecturally unimaginative. It was only after you entered the front door that you could believe that it had cost \$40,000 six years previously. Three bedrooms, three baths, living room, den, dining room and kitchen. Oh! he knew every inch of it: He'd visited there many times. To see Ann, to chat or play cards or watch television with her and her patient.

Dave knew something about the patient, too. Mr. Waring was 63 years old and a widower. He was reputed to be quite wealthy. For more than two years his health had been bad, but recently he'd been on the convalescent side. Taking more of an interest in life, putting up a gallant fight to recover his former good health. That was where Ann fitted

in. She was a graduate nurse, and more. She had a B.S. degree. Her relationship with Mr. Waring had always seemed like a father-and-daughter setup. She took pride in her patient's improvement. Dave knew that she was on duty with him every night, all night: 7 p.m. to 7 a.m. In the day he had a maid to look after him. Well, maybe now that he was dead, Ann would return to normal private duty. Maybe she wouldn't devote the best hours of her youth to helping an elderly man who didn't have too long to go anyway. Dave had never known Ann to take a night off: not one in two years. She not only had been Mr. Waring's nurse, but also a friend and companion.

A policeman halted Dave. The young man explained that he was a friend of the deceased and of the nurse, Miss Sherman. He said, "She called me first. I was the one who advised her to telephone the police."

Dave was escorted inside. It was a U-shaped house. Two lights illumined the patio. On either side of the house were vacant lots, but everything about the house was bright as day.

The patrolman summoned a wiry, compact detective who was talking to Ann in the patio. He introduced Dave Norris, Lieutenant Marty Walsh, Homicide Division, Los Angeles Police Department, gave the young man a firm handshake. He said, "Come on out, Norris. Miss Sherman told us you were on the way over."

Ann looked attractive in her crisp, starched uniform. It was complete except for the cap which she would have been wearing at the hospital.

She had been crying. She was still crying, although Dave Norris could see that she was making a prodigious effort to keep herself under control.

Even under these circumstances, he noticed how pretty she was. 26 years of age, blonde, about five-four in height, weighing in the neighborhood of 120. She came to him and said: "Oh, Dave, I'm so glad you could come."

Her hands were icy. She was looking

everywhere except at the figure sprawled in the green patio chair. That had been Stewart Waring, that had been her patient. Beside the chair were bits of broken glass, a dozen feet away was a .32 caliber revolver. Dave recognized it. It belonged to Mr. Waring and was usually kept in the desk in the den. He'd seen it dozens of times when he'd gone to the desk to fetch cards and score pads for the games of gin-rummy and canasta which Mr. Waring had seemed so greatly to enjoy.

There was blood on the front of Mr. Waring's coat and shirt: not a lot of blood, but enough.

"The heart?" inquired Dave.

Lieutenant Marty Walsh said, "Yep. The heart."

He looked the young man over and liked what he saw. Dave was 29, average height, average build, pleasantly homely. His hair and eyes were brown. He looked like what Ann Sherman had said he was: a graduate of Caltech in electronics engineering who worked for a modest salary in the research laboratory of a firm known simply as Davis Associates. Kind of a lad you'd see anywhere and everywhere and never notice. Confident but not cocky, obviously shocked by the completeness and suddenness of this tragedy.

Marty Walsh returned his attention to Ann. He said, "The boys from the crime lab are on the way. Also the deputy coroner. We're not touching anything until they get here. Meanwhile, we can pick up your story where you left off."

Ann was hesitant. The place was crawling with cops: the four uniformed men, two Homicide detectives, two more from West Los Angeles Division. One of them, a long, lanky individual with keen gray eyes who was introduced as Lieutenant Bert Lane, made a brief report to Walsh.

He said, "The place is wide open, Marty. Vacant lots on both sides. Nice landscaping but no fence. An intruder could have simply walked through one of the lots and into the patio. If Mr. Waring was here alone . . ."

(Continued on page 46)

ELKS NATIONAL FOUNDATION

"The Joy of Giving"



Hand training in occupational therapy for the activities of daily living is being given to this little boy at the North Carolina Cerebral Palsy Hospital at Durham by Miss Flora W. Spurgeon, who is the grateful recipient of a Foundation grant. Miss Spurgeon has been working in the occupational therapy field since 1938.

This gracious letter from Mrs. Dorothy Singer of West Newton, Massachusetts, was received with great pleasure by Past Grand Exalted Ruler John F. Malley, Chairman of the Elks National Foundation, as an expression of appreciation.

"The wide scope of information we were given at the Cerebral Palsy Institute, Boston University, certainly far exceeded my expectations in a course of such short duration. I only wish that every member of your organization could have sat in on the lectures and shared the field trips with us and thereby realize what an outstanding job the Elks are doing in assisting others to solve the many problems of cerebral palsy."

For his outstanding student record, Ward C. Hoskins, Dayton, Washington, was given a dinner in his honor this fall by Walla Walla Lodge, at which time he was presented with a scholarship check for \$500 from the Elks National Foundation. Mr. Hoskins was also granted \$475 from the Washington Elks and a scholarship of \$100 from Walla Wal-



la Lodge for his long list of successes as a high school student. In the accompanying photograph, Exalted Ruler Buck Weathers looks on as Walla Walla Youth Activities Chairman Leonard Cooper makes the presentation.

The Boston School of Occupational Therapy is doing a notable job in training cerebral palsy therapists, and Acile Harrison, Director of Admissions, recently wrote to Chairman Malley, saying: "What a wonderful work you are doing, and how we appreciate your recognition of the need for trained therapists. Your letter has been received, informing me of your generous scholarships of \$750 for each of five of our students, three of whom are Juniors, one a Senior and the fifth a Post Degree student. We shall do everything in our power to assist them to be a credit to the school, the profession and to the kindness shown them by the Elks National Foundation."

First-award "Most Valuable Student" winner of 1955, Kathleen Kampmann, after arriving in England this fall to become a Fulbright student at Oxford, wrote this letter of gratitude to Chairman Malley, showing that our students do not readily or soon forget the generosity of Elksdom.

"I'm realizing more than ever that no matter what the next few years bring in my educational endeavors, this year of liberal arts study at Oxford will be invaluable.

"I think of you and the Foundation so often—and so very gratefully. The Elks National Foundation Scholarship was a wonderful blessing to me last year. It would have been very difficult for me to have finished my senior year at the University of Washington without it. I continue to make every effort to be worthy of the confidence you have placed in me by awarding me the scholarship."

Monroe FOLDING BANQUET TABLES

Direct Prices & Discounts to Clubs, Churches, Lodges, Schools and All Organizations

COMPLETE CATALOG ON REQUEST

MONROE TRUCKS

For handling and storing folding tables and chairs. The easy, modern way. Choice of models.

PORTABLE PARTITIONS

Change your idle space into useful areas with these Partitions. Masonite panels in tubular steel frames with swivel action pedestals and casters or glides.

FOLDING CHAIRS
Steel built, sturdy, convenient.

THE Monroe COMPANY
90 Church St. Colfax, Iowa

LAW...

STUDY AT HOME Legally trained men win higher positions and bigger success in business and public life. Greater opportunities now than ever before.

More Ability: More Prestige: More Money We guide you step by step. You can train at home during spare time. Degree of LL.B. We furnish all text material, including 14-volume Law Library. Low cost, easy terms. Get our valuable "Law Training for Leadership" and "Evidence" books FREE. Send NOW.

LASALLE EXTENSION UNIVERSITY, 417 South Dearborn Street
A Correspondence Institution Dept. 12328L Chicago 5, Ill.

REAL ESTATE

BE A BROKER

PAYS BIG! SEND FOR FREE, BIG, ILLUSTRATED CATALOG NOW! Graduates report making substantial incomes. Start and run your own business quickly. Men, women of all ages, learn easily. Course covers Sales, Property Management, Appraising, Loans, Mortgages, and related subjects. **STUDY AT HOME** or in classrooms in leading cities. Diploma awarded. Write TODAY for free book! No obligation.

Approved for World War II and Korean Veterans

WEAVER SCHOOL OF REAL ESTATE (Est. 1936)
2020H Grand Avenue Kansas City, Mo.

FREE BOOK TELLS HOW

Everlasting Bronze BOOK OF MEMORY

For listing 100 to 3000 names economically. Write for free catalog including photos of hand-chased cast bronze plaques.

NEWMAN BROTHERS, Inc.
Dept. 722, Cincinnati 3, Ohio

SAVE \$7.20 on NORELCO MEN'S ELECTRIC SHAVER...

Latest model, brand new and fully guaranteed. Complete with case, cord and cleaning brush. Regularly retails at \$24.95. Our price \$17.75 postage paid. All orders filled within 24 hours. Your money back if you are not fully satisfied. Send check or money order to:

JOHN BROOKS, Dept. 306, Box 212, St. Louis 3, Mo.

GIVE GOOD CHEER THROUGHOUT THE YEAR

HULL AUTO COMPASS

All on your gift list who receive a HULL AUTO COMPASS will find it a cheerful, welcome companion on every motoring trip... assurance of direct, speedy travel to every destination. Insist on HULL, famous for lasting accuracy, true professional instrument service.

Beaconlite ILLUMINATED \$6.50
Streamline NON-ILLUMINATED \$4.95

At Your Dealer's Write For Literature

HULL MFG. CO. P. O. Box 246, EE-II, Warren, O.

"FREEDOM'S FACTS"—How Communists Exploit World's Youth



The excerpt we are running this month from "Freedom's Facts" is of particular importance because it exposes a facet of Communism which is of utmost concern to this country, namely the at-

tempts to enlist the support of young people by the devious use of so-called "festivals." "Freedom's Facts" is a monthly bulletin of the All-American Conference to Combat Communism, membership of which is made up of fifty national organizations, including the BPOE.

During the next twelve months there is a good chance that some young person in your community will raise a question about a world youth festival to be held in Moscow from July 28 to August 11, 1957.

The event is being billed as non-political. Announcement of the festival from Moscow on August 18 states plainly: "The Sixth World Festival of Youth and Students is open to all youth, irrespective of their convictions, race, religious beliefs, or nationality. No political, philosophical or other tendencies will prevail at the festival. The festival will be held in the spirit of mutual respect and understanding, in the spirit of friendship of the youth of all countries.

In this age of relaxed international tensions, how could an adventurous youngster turn down such an appeal? Even if he does not have money for the trip he can apply to a special "International Festival Fund" which has been set up to pay expenses of young people wanting to visit Moscow.

The recent re-emphasis on the importance of youth activities by the Communist Party, U.S.A., may be reflected in greater efforts to get non-Party American young people to attend the Moscow festival. American youth groups can, at least, expect to receive some of the many propaganda pamphlets, posters and copies of a special newspaper, "The Festival", which the Festival Preparatory Committee will begin to publish this month.

What is behind the youth festival? These festivals are the product of the World Federation of Democratic Youth (WFDY)—one of the many international front groups formed by Communists just after World War II for the purpose of spreading Communism into areas not controlled by the Reds.

The WFDY was formed in November 1945. Coincidentally, the Communist Party, U.S.A., began a review of its own youth activities which—according to testimony before the Subversive Activities Control Board (SACB)—eventually led to the formation of the Labor Youth League (LYL). Primarily, the LYL's job has been to distribute Marxist propaganda to American school and college students.

Any thought that opposition to the Communist point of view might be tolerated at the World Youth Festival is dispelled by the statement by Bruno Bernini, Chairman of the World Federation of Democratic Youth. He said on August 14: "Anyone can take part no matter what organization he belongs to. But the festival is not a tourist measure. Its main demand of young men and women is the sharing of the idea expressed by the festival."

The festival idea is stated in the slogan, "For Peace and Friendship." But to that could be added, peace and friendship along lines set down by Moscow. As has been demonstrated time after time, it is

Moscow's view that those who disagree with Moscow are opposed to peace and are against friendship.

Many people who have seen very little reference to the World Federation of Democratic Youth or to the World Youth Festival in the newspaper might tend to discount the importance of the forthcoming World Youth Festival in Moscow.

Yet such festivals have a great appeal to young people throughout the world. The WFDY claims 83,000,000 members in ninety countries. The actual totals likely are much less than that. Nonetheless, its festivals do attract some very vocal people from many key countries.

The Communist appeals to youth, particularly in the Afro-Asian countries and in Latin America, should be taken seriously. For when world issues such as the seizure of the Suez Canal arise, Communist-dominated youth in many countries shout their cries of support for the Egyptian dictator, Nasser, and against the West almost at the press of a button in Moscow.

As one Latin American government said recently, "Our students who go to Prague will be interviewed and their pictures will appear in the newspapers. They will be overwhelmed by flattery and will believe all that is said to them. Thus, they will return home as propagandists of Lenin and Communism."

If during the next twelve months questions are raised about the World Youth Festival in Moscow, or propaganda for it appears in local youth organizations, every effort should be made to expose the sponsorship and the purposes of the Festival. Parents and youths who might be tempted to favor the Festival through lack of knowledge about it should be courageously and completely informed that it will be a thoroughly Kremlin-controlled affair aimed at exploiting youth in Moscow's drive to Communize the World.

One For the Money

(Continued from page 44)

Walsh said, "Start at the beginning again, Miss Sherman. Make it as brief as you want, but complete."

She took a tight grip on herself, evidently drawing courage from Dave Norris's presence.

"This is all a matter of clinical record," she said. "You can check with Mr. Waring's doctor. Up to a few years ago he apparently had enjoyed perfect health. Then personal tragedy intruded and his health started to fail. They took him to the hospital for observation and an operation."

"He had been living alone?"

"Except for the day maid who has never lived on the premises. Mr. Waring had a de luxe room in the hospital and three special nurses. I was on duty with him from 11 p.m. to 7 a.m. The day they

operated, we all thought we were going to lose him. For a good many days his condition was desperate. Then he started to recover.

"It was a slow job. After six weeks of hospitalization the doctor let him come home. He brought two nurses with him: myself and the day nurse. We worked twelve hour shifts. Eventually he let the day nurse go, but he begged me to stay."

"Why were you more important than the day nurse?"

"He has always had trouble sleeping. My job since then has been more of a companion than a nurse. We watch television together, bet quarters on athletic events, talk, play card games. He usually turns in between 10:30 and 11 p.m. Just before bedtime I give him a glass of wine, which seems to relax him. After he's in bed I give him a vitamin hypo prescribed by the doctor. Then a sedative.

"But he never goes to sleep before one

or two o'clock. Occasionally a second sedative is necessary. The doctor has my charts on all of this. After Mr. Waring turns in, we talk: He in bed, I in an easy chair next to the bed. I try to adjust my conversation to his interests. When I see him getting sleepy I leave the room. The doors are left open. I sit in the den, with my feet on a hassock and—if it's cool—with a blanket over me. If he sleeps, I sleep, too. Two or three times a night, he calls me, using a little bell on a nightstand by the bedside."

"What does he call you for?"

"Maybe because he can't go to sleep and wants to talk some more. Maybe for a relaxing alcohol rub. Most often I fix some warm milk for him. In more than two years I haven't had a night off, and I didn't want one."

"Why?"

"He was dependent on me. I have grown fond of him. And in the last six

or eight months, I've seen him begin to improve. I took professional pride in helping him get well. I got him started going to motion pictures. He has always liked my friends: Dave, here, and one other. They'd drop in occasionally and spend the evening with us. But I made it a rule that whoever was here had to leave at Mr. Waring's bedtime.

"Quite recently I've been convinced that he was really getting well. About two months ago he and I started bowling on Saturday nights. That's where we were tonight."

Walsh asked, "Why Saturday?"

"The alleys around here are usually reserved for league play except on weekends. So we have a standing reservation at a place in Santa Monica at 7:30 every Saturday night. I never bowled before and I'm pretty bad, but he and I have gotten to be good friends and he kids me when I do badly and praises me when I do well. He has been improving. He used to be good until his strength failed. Just tonight he was enthusiastic as a kid because he bowled 168."

"That's better than I ever did," commented Lieutenant Walsh, and Dave Norris said that it also topped his best score.

"Don't get the wrong impression," Ann said. "That was unusual. His average has been about 125. But I have watched the improvement, the reawakening of interest."

Walsh chose his next words with care. "You spent every night here alone with Mr. Waring. I'm just asking . . ."

She met his question squarely. "I told you before that he was like a father to me."

"Yeah . . . I know, Miss Sherman. But sometimes a rich widower and a pretty nurse . . . well, you know what I mean."

Dave Norris broke in: "It's just the way she says, Lieutenant. If there was anything more to it, I'd have noticed."

"Why?"

"Because I used to think I had a chance of marrying Ann."

"And since she's been with Mr. Waring . . . ?"

"Wrong again, Lieutenant. The competition here is another man of my age. Fellow named Ronnie Vickers. He's a good guy. We're friends."

"You're not jealous of him?"

"Sure, I'm jealous of anyone who beats my time with Ann. But what's my bad luck is good luck for him. If she won't have me, then I'd rather see her tied up with a chap like Ronnie."

The men from the crime lab arrived just then, followed by photographers. The patio was suddenly crowded and busy. Marty Walsh said, "They won't take long. We'll continue this after they finish."

Dave nodded. He glanced again at what had been Stewart Waring. He noticed the half-smoked cigarette in the ashtray, the bits of broken glass beside the chair. Marty Walsh said, "They won't take long. We'll continue this after they finish."

"Yeh. Looks like a wine glass. The technical boys at the lab will find out for sure."

Walsh gave some directions to the newcomers. Then he escorted Ann Sherman and Dave into the den. "No use sticking around out there now. Mr. Waring's doctor and the deputy coroner are both on the way. They'll move the body . . ." He offered cigarettes and lighted one for himself.

"One more thing, Miss Sherman: Where were you when Mr. Waring was killed?"

She hesitated. Then she said, "I was in the back bedroom taking a shower. I keep a couple of street dresses here. I never go bowling in my uniform. When we got back tonight—"

"What time was that?"

"Almost exactly ten o'clock. I remember because Mr. Waring had planned to look at a show on television."

"And he didn't?"

"No . . ." For the first time the blonde nurse seemed upset. "He went into the patio instead."

"Why?"

The pause was long and significant. Ann looked first at the detective and then at Dave Norris. Then she said with obvious reluctance, "Ronnie Vickers was here. He'd been waiting for us in his car. He knew we always went bowling on Saturday night. He said he wanted to chat with Mr. Waring."

"So-o-o . . . ?"

"I left them in the patio. I had things to do. I sterilized my needle to give Mr. Waring his vitamin shot. I washed the few dishes he had used for his supper. He eats before I get here. Then I went into the back bedroom and took my shower. I got back into my uniform."

"Was Mr. Vickers still here when you got dressed?"

"No."

"And Mr. Waring was dead?"

Dave Norris broke in, a touch of anger in his voice:

"Is that being fair, Lieutenant? You're setting up something that answers only one way. The chances are Ronnie finished his talk with Mr. Waring while Ann was showering. He probably left right then. Any prowler could have entered the patio from either side. There aren't any fences. It's damned unfair to tie it to Ronnie Vickers."

"Maybe." Walsh got Vickers' address from Ann. Then he asked Lieutenant Lane to take one of his detectives and bring the other young man over for interrogation. Lane said, "Will do," and he and his partner went out through the front door.

Walsh continued his questioning of Ann. "Were you surprised to find Mr. Vickers gone after you got back into your uniform?"

"Not 'specially."

"Any idea what they were talking about?"

"No. I was working in the kitchen at



MEN! Make up to \$1,000 IN A MONTH!

without "SELLING"

Sensational Demand for Low-Priced Fire Alarm PLUS Sure-Fire "No-Selling" Plan Offers Ambitious Men Huge Profit Opportunities



Even beginners cleaning up unbelievable profits with first practical, effective, low-priced Fire Alarm. Needed in homes, factories, offices, stores, on farms, etc. Merlite Fire Alarm hangs on wall like a picture. . . no wiring, no installation. It's always on guard, "smells" fire before danger point. When temperature rises, Fire Alarm goes off automatically, how's loud warning that can be heard 1/5 mile, wakes up soundest sleeper, gives precious time to put out fire, call fire department, or escape. Sells for only \$4.95, with profit up to \$2.70 on each one.

Nearest Thing to Automation Selling

With our field-tested plan customers sell themselves. No cold canvassing; no hard selling. It's the nearest thing to "Automation Selling". Even a child can use plan successfully with powerful sales tools we give you (which you leave with prospects). This plan makes money for you even while you sleep! No room here to give you full details, but write for amazing facts.

DRAMATIC LIGHTED-MATCH DEMONSTRATION

Sensitive! Lighted match triggers Alarm in 3 seconds!

FREE SALES KIT!

Send no money. Just rush your name and address for all the exciting money-making facts, complete Illustrated Sales Kit, everything you need to make money first day. Learn how selling only 20 Fire Alarms a day brings you \$1,080.00 a month. No competition. Get in on ground floor now. Rush your name and address—that's all.

MERLITE INDUSTRIES, INC. (Alarm Div.)
114 E. 32nd St., Dept. S-41P, New York 16, N. Y.

ACCOUNTANT

BECOME AN EXPERT

SEND FOR FREE BOOK

Executive Accountants and C. P. A.'s earn \$4,000 to \$10,000 a year and up. Thousands needed. We train you thoroughly at home in spare time for C. P. A. examinations or executive accounting positions. Previous experience unnecessary. Personal training under supervision of staff of C. P. A.'s and Expert Accountants. Get all the facts. Write for free book, "Accountancy, the Profession That Pays."

LASALLE Extension University, 417 So. Dearborn St.
A Correspondence Institution, Dept. 12325 H Chicago 5, Ill.



KIDS! "BIG" RACKET

Make your Bike sound and feel like a real Motorcycle. Adjustable amplifier for normal or loud noise. Simply attached with screw driver, only **\$1.50**

BIG RACKET MFG. CO.
Box 2121
Colorado Springs 7, Colo.

Midwest FOLDING BANQUET TABLES



A style and size for every need

*** EASY TO SET UP!**
*** STORES COMPACTLY!**

Midwest

When your church, school or club needs folding banquet tables, be sure to see the magnificent MIDWEST line before you buy. No other table offers you so many value-packed features at true budget prices.

Write for FREE catalog, today!
FOLDING PRODUCTS SALES CO., INC.
Dept. 32L
ROSELLE, ILLINOIS

Elks! FOR ALL MEMORABLE OCCASIONS BRONZE PLAQUES

Say it better . . . Say it forever . . . Say it for less
U. S. Bronze leadership in quality and artistry is forever impressing everybody everywhere, and low prices keep our customers pleased, too. Write now for new complete FREE color catalog and information — helpful suggestions for honor rolls, awards, memorials, testimonials, for everything. Write to

"Bronze Tablet Headquarters"
UNITED STATES BRONZE CO., Inc.
570 Broadway, Dept. E, N. Y. 12, N. Y.

March of Dimes Girl Wins Elk Backing



Marlene Olsen, 1957 March of Dimes Poster Girl, was a caller at the Zanesville, Ohio, office of Grand Exalted Ruler Bohn in October. The 4-year-old Burlington, Mass., girl, herself a victim of paralytic polio in 1955, wanted to know whether the

Elks were going to support the 1957 March of Dimes as they have in the past, and took away with her Brother Bohn's assurance that they were.

"I told Marlene that I knew that I could speak with confidence for every Elk in promising her that we would contribute just as generously to the March of Dimes and work just as hard to make the 1957 campaign a success as we have in past years", Grand Exalted Ruler Bohn said. "Our dimes and dollars helped bring about the Salk vaccine that was too late for her, but is protecting her little sister and millions of other boys and girls. We realize that there are many thousands of children and older people, too, crippled with polio, who must be helped and we are not going to let them down. Our March of Dimes contributions will also help to pay for the research that scientists are doing to improve our protection against polio, and that without doubt will lead to conquest of other virus diseases.

"I earnestly urge every Elk and every Elk Lodge to support generously the 1957 March of Dimes."

"How long do you think Mr. Waring would have kept you on as his nurse?"

"Indefinitely. He was desperately ill when I was first with him. He's had a couple of setbacks since. Recently, he's been improving. I take pride in feeling that at least part of it has been due to my help. I'd gladly have remained with him until he was completely well."

Walsh said, "I believe you told me that when you finished showering and got into your uniform, Ronnie had already gone?"

"Yes. I didn't come right out to the patio. I straightened Mr. Waring's room and did other little tasks. I knew he'd be quite tired after bowling. When I did go outside, he was alone."

"And dead?"

She winced and nodded.

"What did you do then, Miss Sherman?"

"I tried to telephone Ronnie. His 'phone didn't answer. I knew he had left here shortly before, and figured he hadn't had time to reach home yet. So I called Dave Norris."

Lieutenant Walsh said, "If he did leave the kind of will you believe, Miss Sherman, that would constitute quite a motive. Some cops might even think you shot him, knowing that Ronnie had been here and could be blamed for it."

She looked at him, saying nothing. The den seemed crowded despite the fact that only three of them were in it. And Marty was thinking. The situation was too simple and too complex. Even if Waring's will did not designate Ann Sherman his heir, it was enough that she *thought* it did. Enough motive for Ronnie, too. As her husband, he'd be sitting pretty financially. And if he had shown up at the house that night in an ugly humor . . . well, anything could have happened.

The front door opened and Bert Lane and his partner returned with Ronnie Vickers.

Vickers was entirely different from Dave Norris in appearance. Whereas the latter was attractively plain, Vickers was a considerable hunk of man: six feet tall, weighing maybe 180, dark, handsome and most definitely angry. Bert Lane propelled him into the den and said, "Here's your boy, Marty. He's been sorta acting up."

"You told him . . . ?"

"Yeh. It seemed best. He started sounding off quick and loud. He doesn't like cops."

Ronnie amplified that statement with a few well-chosen words. Dave Norris said, "Keep your shirt on, fella. That isn't going to get you anywhere."

Marty Walsh came right to the point. "Did you kill Mr. Waring?" he asked Ronnie.

"Oh sure. I machine-gunned him. I stabbed him with a paper cutter. Isn't that the way it's usually done? I choked him to death. Just take your choice."

"Wise guy, huh? Well, that's your

first. When I went back for my shower, they were still there. I didn't hurry. I figured Mr. Waring had company and there wasn't any rush."

"So we don't yet know why Vickers was waiting outside in his car at ten at night. That could be interesting."

Dave Norris said, "I can tell you that much, Lieutenant. But I'm afraid to."

"Why?"

"You seem to be twisting things so that they look bad for Ronnie. But he'll tell you himself . . ."

Marty said, "We've got a dead man out yonder, Mr. Norris. The sooner I get the essential facts, the better off we'll all be. Now then, how do you know what was on Vickers' mind?"

"He told me. We had dinner together tonight. He said—and please don't go putting a wrong interpretation on this—he said that he was getting fed up with the situation."

"Meaning . . . ?"

"He's engaged to Ann. He wants to marry her. She has been with Mr. Waring for more than two years. Ronnie figured that Mr. Waring could afford to keep her indefinitely, and he wanted to talk him into letting her go: to get another nurse. Ronnie was tired of waiting. And I don't blame him."

"Tired enough to—"

"No! Not to shoot him. But he could have become irritated if Mr. Waring refused to release Ann. He probably left Mr. Waring here in the patio, and then some prowler entered through the hedge . . ."

Walsh said, "Nice try, Son. But I can't buy it. There's something missing."

Ann said, "Maybe I can supply that, Lieutenant. You'll find out anyway. Mr.

Waring told me—"

"Ann!" That was Dave Norris talking. "Why diagram it? You don't *know* it was that way."

She said, "I'm reasonably sure. Mr. Waring had no relatives of any sort. He was a wealthy man. Some months ago he told me—in front of both Ronnie and Dave—that he had made a new will designating me his sole heir. Of course, he could have been just talking, but I think you'll find that's how it is."

"Hmmm!" Walsh was really alert now. "So just on the strength of your belief, Miss Sherman, you make yourself a suspect. Do you realize that?"

"Certainly. But I didn't do it, and I'm not frightened."

But she *was* frightened. She was biting her lips and making a too obvious effort to appear calm.

"Just talking to myself," stated the detective. "No offense meant. Groping for the right answers. You can see for yourself how neat the setup is. Mr. Waring dies: You inherit . . . or you believe you do. Not a bad deal for Ronnie Vickers, either. A rich girl eager to marry him. What's his job, Miss Sherman: How much does he make?"

"Ronnie? He's in the advertising business: junior executive. Makes about \$600 per month."

Our January Issue

Next month, Dr. Marcus Nadler, who is Professor of Finance at New York University, will again contribute his annual review of business prospects for the forthcoming year and make suggestions as to how businessmen can meet economic problems.

privilege. Now then, about your visit here tonight—”

“Make anything out of it you want. You obviously know why I came. I told Dave I was planning a showdown with Mr. Waring. He couldn’t see it my way. I got mad.”

“How mad?”

“Plenty. I told him I was fed up. I’d have told Ann that, too, but I didn’t see her.”

“I understand you once heard Mr. Waring say that when he died Miss Sherman would inherit: Is that correct?”

“Sure I heard him say that. And you can build it up real cozy. He gets knocked off. Ann is free. She inherits. We marry. What more could you or the jury want?”

“But you’re trying to create the impression that you didn’t do it.”

“Would I be dumb enough to kill him under these circumstances?”

“I don’t know how dumb you are. But also, it could have been a smart move. The very obviousness of it could work in your favor.”

“Cops!” sneered Ronnie. “Dumb, stupid policemen. Twisting things the way you want them to be. Well, have your fun. I aint playing any more.”

“We could book you,” observed Marty, “on suspicion of murder.”

“What’s holding you? Am I kicking?”

Marty’s voice was level and persistent. “Did you know where Mr. Waring kept his gun?”

“Sure. In that desk yonder.”

“What time did you leave here?”

“About ten-twenty, give or take a few minutes.”

“How did you leave?”

“I walked. On my own two feet. Right around the side of the house. On the concrete. I drove home. I stayed there until these two clowns came and picked me up.” Ronnie was burning. “How come you haven’t got handcuffs on me? Aint you scared?”

“Frightened to death, Ronnie.” The voice of Lieutenant Walsh became suddenly harsh and bitter. “Who are you trying to put on the spot?” he asked.

“Nobody.”

“If you didn’t do it, that leaves Miss Sherman. She was here after you say you left.”

“Yeh. And she says she found Mr. Waring dead. That would eliminate her.”

“Sure. If we knew she was telling the truth.”

“Why wouldn’t she be . . .” Ronnie deflated suddenly. He looked at the pretty young nurse, sitting alone and frightened in the corner. “All right,” he said abruptly. “Let’s say I did it.”

“Playing noble?”

“I haven’t got a noble bone in my body. I hate noble people. But to accuse Ann of doing anything like that . . . who do you think you’re kidding?”

“That’s what I’m trying to find out.”

Dave Norris broke in. His tone was controlled and patient. He said, “Look,

Lieutenant: There’s no sense regarding Ann as a suspect. All right: So she was determined to stay on with Mr. Waring as long as he thought he wanted or needed her. If she changed her mind, all she’d have to do would be to leave. She wouldn’t have to shoot him.”

Marty Walsh said mildly, “That aint quite the way it figures, Son. If Miss Sherman had done that, Mr. Waring would be alive . . . and she wouldn’t inherit his money.”

“We don’t know for sure that she will.”

“We’ll know tomorrow.”

Ronnie asked sharply, “And in the meantime . . . ?”

“One of you could make things easy for us, Vickers. The right one . . . with the right answers.”

Ronnie uttered a single profane word. “So you’ve checked out any idea of a prowler, huh?”

“Just about. No sign of robbery or burglary. A prowler wouldn’t have known that Miss Sherman was in the back bedroom taking a shower. No, it doesn’t add up to a prowler.”

“Then who . . . ?”

“You, Ronnie: You. You had the motive and the opportunity. Oh sure, that goes for Miss Sherman, too, but I don’t figure she did it. Not from what I know so far.”

The two other detectives moved unobtrusively closer to where Ronnie Vickers was standing. They knew he wasn’t armed, but there was always a chance that he’d make a move. Dave Norris said, “Don’t worry, Ronnie. They can’t prove a thing.”

“No,” responded Walsh, “but it’ll sound impressive before a jury.”

“Circumstantial evidence!” snapped Ronnie. “What good is that?”

“In murder cases it’s often enough. Killers don’t usually distribute tickets in advance.”

Ronnie Vickers stood tensely for a moment. Then he made the move that had been anticipated.

He lashed out suddenly and slugged the detective nearest to him. He made a leap for the door leading to the patio. Bert Lane and Marty Walsh were on him instantly.

They thrashed around on the floor, knocking over furniture, smashing a lamp. Ronnie was tough. It was a brief but merry fight. When it was over they hauled Ronnie to his feet. There was blood on his lip, and Marty Walsh’s nose was bleeding. Walsh said, “That does it. Put the cuffs on him.”

The second detective pinioned Ronnie’s arms behind his back—not without difficulty—and Bert Lane’s handcuffs clicked. Walsh said bitterly, “How far did you think you’d get with that dumb play, Vickers? One block maybe: two blocks? Let me give you some advice for future reference: Never fight cops. You’re outmanned and outgunned.”

Ronnie’s reply was graphic and terse. He stood motionless while Ann Sherman



Checkерette
COAT and HAT RACKS
for every Church need

A 4 ft. (S-4-CT) Checkерette provides ventilated hat shelves and either 24 coat hangers or 32 coat hooks. A double (D-4-CT) Checkерette of equal length accommodates 48 on hangers or 64 on hooks. Both can be set-up anywhere or disassembled in less than a minute without nuts, bolts or tools, can be stored like folding chairs, or will stand rigid for years. The double Checkерette comes on large casters for easy movement when it is assembled. Checkерettes can be assembled “high” for robes or vestments, “normal” for adult wraps or “low” for children. Checkерette Wall Racks come in 2, 3 and 4 ft. lengths and will accommodate up to 12 coats and hats per running foot. They are mounted on wall at proper heights for each age group. Write for Bulletin CT-3 showing these and other modern steel wardrobe units.

VOGEL-PETERSON COMPANY
The Coat Rack People
1127 West 37th Street, Chicago 9, Illinois



Reflexite
AUTO EMBLEM

4 1/2" Emblem in 5 colors. Stainless Steel frame. Attaches to license plate. Shows up clearly day and night.

Price each, prepaid \$1.75

RUSSELL-HAMPTON CO.
303 W. Monroe St., Chicago 6, Ill.

\$495 down starts you in your OWN \$25,000 yr. Business

World-wide organization seeks reliable men. Start part time if you wish. We locally train you, furnish everything to clean & mothproof rugs, upholstery on location. No shop needed. Quickly established. Just 3 average jobs a day bring \$25,000 in business. Employ helpers and multiply profits. You will be only service in town receiving National Advertising. Parents' Seal. 25 other regular services. \$495 down required. Balance on easy terms. Send for FREE Dealership Program. Duraclean Co., 6-54D Duraclean Bldg., Deerfield, Ill.



UNIQUE NEW DISCOVERY! PIPE!

Why smoke ordinary pipes when you can enjoy the luxury of this new miracle? Write postcard, or coupon, get my EYE-OPENING picture explanation and unusual 30 day free trial offer. You'll say it's too good to be true. Made in England. E. A. CAREY, 1920 Sunnyside Ave., Dept. 1012, Chicago 40, Ill.

Mr. Carey: Please send facts about the Carey Pipe. No obligation.

Name _____
Address _____
City _____ Zone _____ State _____

BOOK MANUSCRIPTS
CONSIDERED

by cooperative publisher who offers authors early publication, higher royalty, national distribution, and beautifully designed books. All subjects welcomed. Write, or send your manuscript directly.

GREENWICH BOOK PUBLISHERS
Attn. Mr. Essex 489 Fifth Avenue
New York 17, N. Y.

HUNDREDS OF IDEAS
for **BRONZE PLAQUES**

FREE illustrated brochure shows hundreds of original ideas for reasonably priced solid bronze plaques—nameplates, awards, testimonials, honorrolls, memorials, markers.

Write For **FREE BROCHURE A**
For trophy, medal, cup ideas ask for Brochure B.

INTERNATIONAL BRONZE TABLET CO., INC.
Dept. 40—150 West 22 St., New York 11

A PROCLAMATION

WHEREAS, the Order of Elks maintains at Bedford, Virginia, the Elks National Home, where members who have retired are privileged to live as guests of the Order, enjoying all the comforts and conveniences that this great fraternity can provide, and

WHEREAS, the spirit of Brotherly Love that brought the Home into being has blessed it with peace and happiness, the warmth of good fellowship and abundant hospitality, thus making it a Home where life is attractive and full, providing not alone for the physical comfort and well being of the gentlemen who dwell there, but also for their spiritual and intellectual needs,

NOW, THEREFORE, I, Fred L. Bohn, Grand Exalted Ruler, do proclaim Elks National Home Month to be observed during the month of January throughout the Order in all appropriate ways that will focus attention on this achievement that reflects so much credit upon the Order, so that all members will become more fully aware of the Home. I ask those with friends or acquaintances resident in the Home to write to them and otherwise remember them during this month. I suggest, also, that those Lodges that have members living in the Home extend official greetings to them so that the bonds of Brotherhood be strengthened.

FRED L. BOHN, *Grand Exalted Ruler*

"I am thinking carefully. It just took me a long time to understand."

Walsh said kindly, "Let's have it, Miss Sherman."

She pulled herself together with an effort. "Dave claims he wasn't here at all tonight. He was. I figure he saw Ronnie leave, saw I wasn't around . . . and went into the patio then."

"Go ahead."

"When you were showing me Mr. Waring's body," she went on, "Dave Norris was here. Before that I had described my nursing routine. I told you that always, before bedtime, I served Mr. Waring a glass of wine. He never was a drinker, but that helped to relax him. The wine is kept in a kitchen cabinet."

"So-o-o. . . . ?"

"You showed me the pieces of broken glass right alongside of Mr. Waring's chair. We all agreed that he was holding it when he was killed. Well, Lieutenant, I didn't give any wine to Mr. Waring tonight."

Dave Norris said sharply, "That doesn't prove a thing. He could have gotten it himself."

"Maybe. But, Dave, when you mentioned it, you said sherry. Mr. Waring never drank sherry. Always port. Tonight he decided to change. On my way here to work I bought one bottle. Only one. It's the first sherry that has been in this house in all the time I've been here."

"That doesn't prove. . . ."

"Yes it does, Dave. You haven't been out of sight of the detectives since you arrived. You certainly haven't been in the kitchen. Yet somehow you knew the wine in that glass was sherry. You opened the bottle and served it to Mr. Waring. That's how I know you had been here. You were here after Ronnie left and before I finished getting into my uniform."

Walsh made an exclamation. He directed one of the other detectives to take the cuffs off Ronnie Vickers and to snap them on Dave Norris's wrists.

"Sounds good to me, Miss Sherman. But the motive?"

"I used to be in love with Dave," she stated quietly. "He knew that Ronnie was coming here tonight for a showdown with Mr. Waring. It was a perfect setup. If Ronnie were convicted of murder I had only one friend left. It would have been simple—perhaps—to have fallen in love with Dave again."

Marty Walsh said, "Thanks, Miss Sherman. You've really wrapped it up."

And it was still being done. But this time in a different way. Ronnie Vickers, his belligerence gone, was in the process of wrapping Ann Sherman up.

"I'm awful sorry for Dave," he said, "but glad for us." He shook his head and spoke to Marty Walsh. "What impresses me," he said, "is that this is a mighty unusual setting for a love scene."

"Go right ahead," grinned Lieutenant Walsh. "This one is on the house."

walked over to him and inspected the cut on his mouth. She said, "Oh, darling . . . I wish you hadn't . . ."

He said, "They were ganging up on you, Ann. That's what they had in mind from the first."

"Yeah?" Marty was speaking. "So maybe we changed our minds. Every minute that passes, Vickers, you look more like our boy."

"If you didn't have these cuffs on me—"

"But we have. And so maybe we'd better go downtown where we can talk it over at leisure."

Ann said, "I'll go with you, darling," and Dave Norris said, "So will I."

"Quite a party." Ronnie was still belligerent. "Meanwhile, some stranger is probably walking the streets wondering why he isn't being molested."

"Maybe." Marty had staunched his nosebleed. "You said a little while ago we were trying to gang up on Miss Sherman—trying to catch her with her guard down. That was cute thinking. But it wasn't accurate. You've been our baby ever since you were brought into this room. This time we know we're not wrong."

Ann Sherman's voice, low and clear, picked up Marty's statement.

"Yes, you are," she said.

"Huh?" All three of the detectives looked at her. She was white and shaken, but her voice was steady.

"You're wrong," she repeated. "Ronnie didn't kill Mr. Waring."

Walsh said, "You seem mighty sure of yourself, Miss Sherman."

"I am sure. Now. At first it didn't register. Just this instant I got the answer."

"Are you confessing?" inquired Marty.

"No."

"Then who killed Waring?"

She was having a tough time. The words were there, but she had difficulty getting them out. Finally they came.

She said, "Dave Norris killed Mr. Waring."

There was an instant of shocked, startled silence. Then Dave's voice broke it. "I wasn't even here," he said. "I had been to a movie in Westwood. I had gotten home less than ten minutes before you telephoned me."

Ann said, "You'd swear to that, Dave?"

"Of course I'd swear to it."

Ann Sherman faced Marty Walsh. She said, "Dave Norris was here," she said. "He's lying when he says he wasn't."

Marty Walsh said, "Did you see him, Miss Sherman?"

"No."

"Then how can you be sure?"

She said simply, "He told me."

Marty shrugged. "Reckon I'm stupid," he said, and Ronnie Vickers broke in with, "You sure are, Buster."

Walsh focussed his attention on Ann Sherman: "You say Dave Norris told you . . . ?"

"He told you, too," she said. "But it didn't register. There was no reason why it should."

Dave interrupted. He said, "You're all unstrung, Ann. Please think very carefully."

Baseball's Mr. Fixits

(Continued from page 13)

one ball club. No other baseball man can make a similar claim.

Eddie Brannick goes all the way back to the days when he was John McGraw's office boy and his memories are a melange of Merkle, Mathewson, the mid-30s of Hubbell and Schumacher and Terry, the miracle club of '51 and the devastating four-game sweep over the '54 Indians in the World Series. He is the handiest kind of a fellow to know if you ever get into a jam—with a traffic cop, the tax man, or your mother-in-law.

Brannick is a baseball man in a baseball job, but the road secretary slot is open to others. Newspapermen gravitate toward it, and some make excellent functionaries. In Brooklyn, Lee Scott, once a baseball writer on the defunct "Brooklyn Citizen," followed Harold Parrott, former "Brooklyn Eagle" columnist, as Dodger road secretary. As a newspaperman, Parrott is remembered as being socked once with a \$500 fine by Happy Chandler because he had pointed the finger at a couple of people while writing under Leo Durocher's by-line. Chandler found out who was spelling correctly for Durocher and nailed Parrott, who has gone on to become business manager of the ball club.

LEE SCOTT worked for a tiny paper of almost non-existent circulation which survived for a great many years on legal-notice advertising. Finally even that wasn't enough to keep the "Citizen" afloat. It floundered but not before Scott set some kind of a record for an unrecognized scoop. Two weeks before the official announcement of a change of managers Scott had it, in print, too.

No one bothered to read it because no one saw it. When the ball club finally made its announcement it provided headlines even though Scott insisted, "Hey, I had that two weeks ago."

As road secretary for the Dodgers, Scott has had a lot of entertaining things happen to him—entertaining of course in retrospect. Only as recently as last season he had one of those "lost-list" jobs pop up, right in the middle of a scorching pennant race. Funny enough now but horrifying when a club is engaged in a to-the-death struggle with teams like Milwaukee and Cincinnati, and certainly in no position to give up a night's sleep dozing in hotel lobby chairs.

Hotels don't break their necks today for ball-club business the way they did in the pre-World War II days of 70 per cent occupancy. Today a ball club asks for a special rate and frequently a hotel will take its chance on the full rate from a lot of separate customers against the assurance that the Dodgers, or the Yankees, or any other club is bringing in between forty and sixty customers, none of them especially careful about the prices on the menu, for a definite number of days.

Chicago has been an unsatisfactory hotel town for the Dodgers for a decade. They've bounced around from one hotel to another, smarting under indifferent service but with no noticeable improvements stemming from the changes. They went from the Stevens, to the Knickerbocker, to the Edgewater Beach and back to the Stevens which had undergone a name-change and was now the Conrad Hilton. Always there was some rub, like the night one hotel sent half the ball club off to sleep in some nearby small hotel because some underling had made a mistake with the rooming list and had released half the rooms blocked off for the Dodgers.

Last summer's mix-up was the best of all, however. The club had ridden the train over from Milwaukee and now they were in the surging lobby looking for their rooms. There weren't any. Moreover, they ran into a one-in-a-million situation in a rooming clerk who not only was unaware of any reservations for a party of fifty-five but didn't even know who the Dodgers were, an almost fantastic development in this age.

Anyway, there was no room at the inn, and he was very, very sorry. Scott stormed around a while and finally wheels began to move, ever so slowly. Brooms were emptied from closets and ball players installed therein. Eventually everyone was assured of a bed for the night—everyone except the newspapermen.

What to do about them? Best accommodations the hotel was able to offer in this respect was a small ballroom with twelve hastily thrown-together beds. It had been some time since most of the newspapermen had been in the Army or had been war correspondents enjoying barracks accommodations. For one of them the last time he had slept under such conditions was during the Spanish-American War.

There were complaints when they started to kick off their shoes. The complaints swelled when it was discovered that there was only one key to the room. When further examination revealed only one bathroom, oh boy! By morning the fierce complaining could be heard away over on the Loop.

One of the reluctant bedfellows summed it up neatly with, "Imagine them putting twelve newspapermen into one room and asking that they live together! It's tough enough for us guys even to live by ourselves. Wait'll I see the road secretary."

Baseball players, officials, newspapermen, and even fans, red-hots whose slightly-nutty rooting gives them the cock-eyed idea that they're entitled to special privileges, have been "seeing" road secretaries for years. It makes you wonder why a fellow ever takes the job, particularly when there isn't the remotest possibility in some cases of a World Series cut be-

"I'M MAKING MORE THAN \$1000 a Month



C. KAMA



HAVEN'T TOUCHED BOTTOM YET!"

—reports Charles Kama, Texas, one of many who are "cleaning up" with orders for PRESTO. Science's New Midget Miracle Fire Extinguisher. So can YOU!

Amazing new kind of fire extinguisher. Tiny "Presto" does job of bulky extinguishers that cost 4 times as much, are 8 times as heavy. Ends fires fast as 2 seconds. Never corrodes. Guaranteed for 20 years! Over 2 million sold! Sells for only \$4.95.

Show it to civil defense workers, owners of homes, cars, boats, farms, etc., and to stores for re-sale—make good income. H. J. Kerr reports \$20 a day.

Wm. Wydallis \$15.20 an hour. FREE Sales Kit. No obligation.

MERLITE INDUSTRIES, Dept. P-41R
PRESTO DIV., 114 East 32 St., New York 16, N.Y.
Canada: Mopa Co., Ltd., 371 Dowd St., Montreal 1, P.Q.

62 BALLOONS \$1
THAT MAKE GIANT
CIRCUS ANIMALS

GREAT FOR PARTIES, Instructions Included.

124 BALLOONS \$1.75

ADD 10c POSTAGE PER ORDER

Circus Balloons, Dept. D3 • Scarsdale, N. Y.

AUTHORS:
TALENT
GOING TO
WASTE?

If you are the talented author of an unpublished manuscript, let us help gain the recognition you deserve. We will publish your BOOK—we will edit, design, print, promote, advertise and sell it! Good royalties.

WRITE FOR FREE COPY OF HOW TO PUBLISH YOUR BOOK

COMET PRESS BOOKS, Dept. BP2, 200 Varick St., N. Y. 14



for
AULD
LANG
SYNE

For that worthy member who can point to 25 years of membership in the Elks here is a gift that he's sure to prize highly as a token of the many years he has been an Elk and for the whole-hearted warmth of feeling it expresses. Yes, 25 years IS a long time and well warrants recognition and there's scarcely a better way to show this than by giving that Elk one of these handsome, 10 kt gold, splendidly enameled red, white and blue 25 year membership pins. A Christmas gift unusual. 10 kt gold plated post and attaching button. Please order by number. 25 year pin No. 3—\$8.25. Price includes Federal tax. For N. Y. City sales add 3% tax. Delivery within 2 weeks. Order TODAY from THE ELKS MAGAZINE, 386 Fourth Ave., N. Y. City 16, N. Y.

SALES OPPORTUNITY

If your present income has been reduced due to short work week, or you have reached retirement, this is an opportunity to earn from \$150 to \$500 per month on a part time basis, selling our exclusive calendars, plastics, specialties and executive gifts to banks and business firms. Full time earnings much larger. No investment necessary. Year-round income. Local territory. Write for 48 page illustrated brochure of details. Our company established 1896 and serving thousands of customers throughout the nation. Write Bankers Advertising Co., Dept. E, Iowa City, Iowa.

cause of a club's chronic second-division status.

Road secretaries come from all walks of life. Some, like the Braves' Duffy Lewis, who played in the best Red Sox outfield of all time—Lewis, Tris Speaker and Harry Hooper, have had impressive careers as major-league players. Others have had only a "cuppa coffee" in the big leagues as a player. Some are ex-transportation officials attracted by the lure of the game. Some are road secretaries because baseball runs in the family.

Duffy Lewis's reason for becoming a road secretary was simple, if you'd believe Casey Stengel. Stengel managed the threadbare Boston Braves in the days when Duffy was his road secretary, spending most of his time ducking irate railroad men waving unpaid bills.

"Duffy became a road secretary," advises Casey, "because he liked to sign checks and write in green ink."

Harold Parrott became Brooklyn's road secretary because Branch Rickey liked the way he worked when he interviewed him on a story. Said Rickey: "I knew he was a good newspaperman and would be good in anything else he tried because he had a large notebook and wrote down everything I said." Rickey was apparently unaware of the Satre-Humperdinck school of reporting which holds that a man can commit everything, including punctuation marks, to memory.

Bill McCorry, of the Yankees, responded to a hurried call when the '51 road secretary, Jackie Farrell, underwent major surgery in Phoenix during spring training. McCorry brought with him an 0-and-2 record as a pitcher with the 1909 Browns, a little item which such needlers as Whitey Ford and Tom Morgan were quick to seize upon.

Needling or not, McCorry has had four winning World Series cuts in six years. He is also a forthright man who believes in direct action. When it became obvious that small boys and grown girls rapping on hotel doors for 8 a.m. autographs were not going to help the Yankees clinch the pennant for '56 on their last trip through Kansas City, he told the front desk at the Muehlebach Hotel not to give out any room numbers. Also, all calls for people on the ball-club list were to be routed through his phone.

His sweeping edict failed to separate the men from the boys and he had some rather interesting phone conversations before the Yankees hopped on their special train for Detroit where the populace was a little less Yankee-minded.

The road secretary's job frequently can lead to other things. In Cincinnati James (Scotty) Reston came down from Columbus in the late 30's to take the job at Larry MacPhail's suggestion. Scotty was a golf-crazy kid a couple of decades ago and had met the mercurial MacPhail on some tournament tee. Eventually he ascended from that job to chief Washington correspondent for the "New York Times," a unique switch on the news-

paperman-to-road secretary progression.

Or take Gabe Paul, who followed Reston as road secretary in Cincinnati. Paul started out as a batboy in Rochester, hitched his wagon to Warren Giles' star, went to Cincinnati with him, and moved into the general manager's spot there a half-dozen years ago when Giles went on to become president of the National League. The current Redlegs club, which will prove a potent factor in the '57 pennant race, is largely Paul's handiwork.

With a club like Cincinnati, Paul's road-secretary tasks were only moderately taxing, compared to a club that travels with a dozen newspapermen, a raft of officials, and is always in contention. His players, after the early '40s dip, were only too happy to be around on a major-league payroll. Gabe's main concern was to make sure that Tom Swope, of the "Cincinnati Post", was always supplied with light bulbs of sufficient wattage. Swope, a veteran of almost a half-century of baseball coverage, still is infatuated with averages and figures. He insists doggedly that hotels never have large-enough light bulbs to permit him to carry on his work.

THERE is a saying attributed to various road secretaries which just about embraces the entire philosophy of the job. The quote is a thoughtful boast, "I've never lost a trunk, a player, or a sports writer."

The man who actually said it, at least said it for the first time, was the late Mark Roth, who shepherded the Yankees around from 1915 through 1943, ministering to the needs of such men as Babe Ruth, Lou Gehrig, Lefty Gomez, Joe DiMaggio, and such managers as Miller Huggins and Joe McCarthy. Roth was undoubtedly correct because no one ever reported the loss of such Yankee items to the police, but Roth was always at great pains not to include road secretaries in this group.

That was because Roth once got himself lost on a Yankee road trip. On a Western swing, bound for St. Louis, the train stopped inexplicably in the prairie countryside. Roth, thinking the train was just outside the St. Louis railroad station, which has been known to confuse people because trains back in there, instead of pulling in, stepped off. Without warning the train chugged off. A taxi had to be sent to rescue Roth with a 25-mile ride into town.

One of the more interesting aspects of the road secretary's job is the pairing of players for rooming purposes. Unless you're a Ted Williams, or a Bob Feller, or some other super-star, you live two to a room on the road.

Frequently the road secretary is advised by the manager and/or the front office on whom to put in with whom. The idea is that an older player will cut down somewhat on the capers of a younger man, especially one feeling his oats via a meteoric rise.

On the Yankees, Mickey Mantle was

first roomed with Billy Martin. Things didn't work out exactly the way the management hoped with these two blithe young spirits, so when Martin returned from his Army service he found that his old buddy had been paired up with Jerry Coleman, the club's player-representative, and a veteran of two Wars as a Marine flier.

Further discretion has to be exercised in pairing players to make sure that two intensely-competitive men aren't thrown together to sleep out the small hours of the night in the same room. Pitchers for instance. If you pair them, you try to put a lefthander in with a righthander, not two righthanders, both of whom are shooting for a job on a staff which has only a limited number of openings. The same goes for pairing outfielders, infielders, and catchers.

Sometimes pairing a couple of clean-living kids with the same tastes can produce unexpected results, too. Take the time last season when a couple of fellows in their early twenties were bracketed on the Yankee rooming list. One was an infielder, the other was a pitcher, and all they did with their spare time on the road was to go to the ball park in the daytime and the movies in the evening, or vice versa, if it was a night game.

What the road secretary didn't know, however, was that they both shared a passion for late movies on TV. There was an amusing development when they found themselves in a TV-equipped room in Detroit. After a night game during which they were baffled repeatedly by the offerings of Frank Lary, the Tigers' extremely able righthander, they sought relaxation by watching one of those late-late shows.

Between their room and the adjoining one, containing one of the newspapermen traveling with the club, was nothing but a thin brown door. And they were playing the set pretty strenuously.

The newspaperman tried to relax, too, only his try was in the direction of sleep. He found, however, that the ten-year old slang which went with the picture pierced his ear-drums in unremitting waves. Finally he decided he was getting nowhere in bed, so he hopped out, unlimbered his typewriter, banged off a couple of lengthy letters. Some time before dawn the TV set expired, and so did he.

At breakfast one of the young players accosted him and observed, "Hey, you were up real late last night writing. I could hear your typewriter going until I fell asleep."

He was rewarded with a noncommittal "Yep."

"What were you writing?", persisted the young man, "a book?"

The newsman's baser emotions started to get the upper hand. His lip curled slightly. "A movie scenario."

There was a flurry of interest.

"For TV?"

"Guess so."

"What are you going to call it?"

"'Birth of a Nation.'"

The player thought a while. "Oh," he said, "about kids, eh?"

Kids, too, are somehow road secretarial problems—sometimes their own, mostly other people. Kids are always getting lost in baseball, either in the park or leaving it. Usually the road secretary winds up in the straightening-out chores.

About a generation back, Brooklyn's Daffiness Boys under the fabulous Uncle Robbie included Babe Herman, an outfielder of heroic proportions. Herman brought his small son out to Ebbets Field one afternoon to watch him shag flies off the top of his cap. Brooklyn won the game, an infrequent occurrence, and in the confusion attendant upon the triumph, Babe Herman showered, dressed and departed, leaving his small son seated in the grandstand, presumably wondering when the next game was going to start.

Joseph (Babe) Hamberger, whose multitudinous duties with the Brooklyn club of that era included those of the road secretary, came by, making a final check to make sure no one had pilfered a seat in the excitement. He spotted the boy and took him home. If it's any consolation to Babe Hamberger that boy grew up to become an outstanding figure in the operatic production world.

A name like "Babe Hamberger," connected with the Dodgers of that wild and wooly era would almost seem to have been a figment of some wise-guy scriptwriter's typewriter, a fellow who never made it East of the Mississippi. Actually Hamberger is the Babe's correct monicker and his half-dozen children bear it, too. When he was promoted from clubhouse man to road secretary, one of the more urbane Dodgers took him aside and in a friendly fashion suggested, "Why don't you use your REAL name now? You got a job where you gotta show a little dignity."

SOMETIMES it's difficult for a road secretary to maintain his dignity under the especially-ludicrous circumstances that pop up along the way, like when he gets that "It's the other union's job to handle it from here." That means he has to toss fifty heavy suitcases aboard a train while the conductor stands by, impatiently watching the second-hand on the onion-like timepiece handed down to him by his grandfather. But if he loses his sense of humor, he's a goner. In this connection a road secretary is afforded plenty of opportunities to exercise his ability to laugh, at himself and at others.

Eddie Brannick, in this respect, is a past master, although admittedly he's had a lot of years in which to master the technique. His observation, to irate player or writer, "You're all washed up but you still look nice and clean," has softened many a wrathful phrase. He has an instinct for divining a person's soft spot, whether it be money, maidens or madrigals.

They still tell about the way he smoothed out a tense situation one night in Chicago. The Giants had come over

from St. Louis and in a baggage foul-up one of the writers found his nice, new portable typewriter was now en route to Midway Airport to catch a plane for Los Angeles. He found Brannick in the Colonnade Room and for five minutes you'd think the roof was going to be blown right off into nearby Lake Michigan.

Brannick listened carefully, then beckoned a waitress. He slipped her a fiver and said, "Bring this man five dollars' worth of chocolate ice cream."

More than a little startled, the waitress obliged. Five dollars bought an awful lot of chocolate ice cream, even in fancy places, in 1947. Brannick happened to remember the reporter's scarcely-controllable yen for chocolate ice cream. After a while everyone was roaring with laughter, including the reporter who was ticketed to write with a stub pencil for the next few days. I know. I was that reporter.

But the wet-nurse aspect of a road secretary's duties extends beyond the reporters traveling with the club. Some ball players have amazing ticket requests when the team gets into a town close to their home territory. Preacher Roe's appearance in St. Louis, for instance, used to empty half the Ozarks. All kinfolk, too.

Roe's problem was handled in simple fashion. The road secretary decided that every player on the club had asked for his maximum free allotment that day. Had they bothered to inquire they'd have discovered tickets being asked for in their names in heavy Arkansas accents.

Some players have much more serious requests, like those involving money. Here a road secretary has to exercise a lot of diplomacy because he doesn't know whether the player is slightly overdrawn at the front office or not. Also, he might be ticketed for the minors. In any event it's what used to be called in military circles, a "field decision."

In this connection, Bill McCorry, the Yankee's spry septagenarianish road secretary, had an interesting experience last Fall. On the morning of Oct. 8, Don Larsen, the righthander, shambled up to McCorry in the Yankee dressing room and asked for two hundred. "I need it to get home (San Diego)," he explained. "I'm broke."

McCorry took pains to explain that 200s aren't found under every rubbing table and Larsen asked what was he gonna do?

"You win today," offered McCorry, "and I'll get the 200 for you somehow."

How Larsen won that day in a perfect game that required only ninety-seven pitches has been recounted elsewhere in several million assorted words. Now the game was over and somehow McCorry managed to claw his way through the churning mass surrounding Larsen. In his hand he had a check for \$200, his promise made good.

Larsen, busy clubbing away advertising agency emissaries armed with blank contracts barely gave it a glance. "Keep it Bill," he advised, "I've just made \$2,000 in the last ten minutes."

HOW TO HEAR BETTER WITH OR WITHOUT A HEARING AID

Do you know that by sitting in a certain part of a room you can hear better? Do you know how to listen to a person who mumbles? If you are only slightly hard-of hearing, there are many ways you can hear better without using mechanical assistance. As a public service, Maico has prepared a booklet filled with hints and tips on how to get the most out of the hearing you have. It's a valuable booklet and it's yours free. We'll mail it to you in a plain envelope.

The Maico Company, Room J
21 North 3rd Street, Minneapolis, Minn.

Name _____
Address _____
City _____ State _____

If Ruptured Try This Out

Modern Protection Provides Great
Comfort and Holding Security

Without Torturous Truss Wearing

An "eye-opening" revelation in sensible and comfortable reducible rupture protection may be yours for the asking, without cost or obligation. Simply send name and address to William S. Rice, Inc., Dept. 13F, Adams, N. Y., and full details of the new and different Rice Method will be sent you Free. Without hard flesh-gouging pads or tormenting pressure, here's a Support that has brought joy and comfort to thousands—by releasing them from Trusses with springs and straps that bind and cut. Designed to securely hold a rupture up and in where it belongs and yet give freedom of body and genuine comfort. For full information—write today!

Don't Neglect Slipping FALSE TEETH

Do false teeth drop, slip or wobble when you talk, eat, laugh or sneeze? Don't be annoyed and embarrassed by such handicaps. FASTEETH, an alkaline (non-acid) powder to sprinkle on your plates, keeps false teeth more firmly set. Gives confident feeling of security and added comfort. No gummy, gooey, pasty taste or feeling. Get FASTEETH today at any drug counter.

DON'T PULL HAIR FROM NOSE

May Cause Fatal Infection

Use the **KLIPETTE** Rotating
Hollis Scissors



So Simple!

You can cause serious infection by pulling hair from nose. Ordinary scissors are also dangerous and impracticable. No better way to remove hair from nose and ears than with KLIPETTE. Smooth, gentle, safe, efficient. Rounded points can't cut or prick skin. **\$1** Made from fine surgical steel Chromium Plated

Guaranteed to Satisfy or Money Back
HOLLIS CO. • 1133 Broadway, New York 10, N. Y. • Dept K-17
Enclosed is \$1.00 for KLIPETTE. If I am not entirely satisfied, I may return it within 10 days for refund.

Name _____ Address _____

54



WORKSHOP

Wall desk packs utility into small space.

BY HARRY WALTON

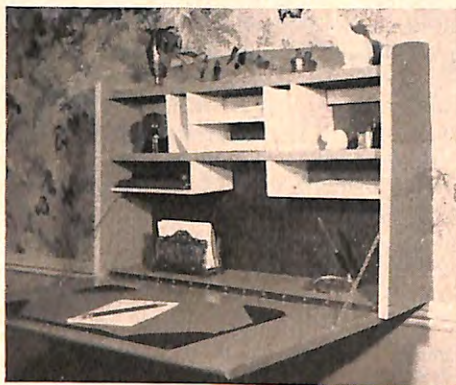

A MAP, PRINT OR DECAL may be applied to decorate the drop door. For opening it, mount a shallow, rounded drawer handle that won't catch against knees when one sits down to write.

SOMEWHERE in your house this wall desk might fill a gift-item need perhaps not yet realized. Taking no floor space at all, it closes to a mere 8" in thickness. With a picture framed on its door, it looks well closed or open.

In the living room, it can serve as a secretary, in the kitchen as a recipe center and a place to keep bills, write checks and save receipts. In a child's room it provides a spot to do homework.

SOLID LUMBER IS BEST for the case or body, as it eliminates the need for filling plywood edges. For the door, however, nothing serves as well as $\frac{3}{4}$ " plywood. Many lumber yards now sell part panels and odd-sized pieces, so it should not be necessary to buy a full piece.

The sizes given in the drawing and text make a shallow, compact desk. For a deeper, roomier one, increase all depth dimensions equally one inch or even two.

You can cut the two ends from 1" by 8" pine (this size board actually measures $\frac{13}{16}$ " by $7\frac{5}{8}$ " when surfaced). After sawing square and to length, lay out the taper and the top curve as in Figure 1.

The curve can be cut by hand with a coping saw, and the straight taper with a rip saw. Blend the two cuts to the layout line with a plane or rasp and coarse sandpaper, following with medium and fine paper until the edge is velvet smooth.

The bottom must be cut from 1" by 8" stock, but the top and the shelf can be ripped to width from 1" by 6" board. If you use a circular saw, tilt the blade or the table at 6 degrees to get the necessary bevel on the front edges. If you rip these parts to width by hand, plane the front

edge of the top and bottom to this angle.

CHOOSE THE BEST FACES of the two ends to go outside, and mark the insides. On these inside faces, mark the locations of the shelf and the top as in Figure 1. Use rule and square to do this accurately, and check one piece against the other to make certain they are alike. Draw the pencil lines lightly; heavy ones are hard to remove and annoying if you want a clear wood-grain finish.

Note that the top and the bottom are both set in $\frac{3}{4}$ " from the front edges of the ends to accommodate the door. The top is narrow enough to be set in at the back also. This is to receive the back board, which braces the frame and provides a sturdy member by which to fasten the desk to the wall.

Saw this back board to exactly the same length as the other horizontal members. Measure down 1" at each end as shown in Figure 2 and rip a taper from this point at each end to the middle. Plane and sand the edge smooth.

TO ASSEMBLE THE CASE, clear a table or the workbench top. Make a trial assembly (with the pieces lying on their back edges) to make certain they are the right size and in proper order. Be sure the beveled edges of the top and the bottom slope in the right direction.

Though set back from the front, the bottom and the shelf fit flush at the rear (that is, their back edges are even with those of the ends). Set the back board in behind the top as shown in Figure 4.

For a wood-grain finish, dowel joints are desirable to avoid the use of filler (otherwise necessary to close the holes over wood screws). For an enamel or paint finish, you can assemble the desk with glue and $1\frac{1}{2}$ "-8 wood screws, well countersunk and puttied over.

The two parts comprising each joint should be accurately aligned and the holes for dowels or screws drilled through the endpieces into the horizontal ones. One way to hold the parts is to clamp a strip

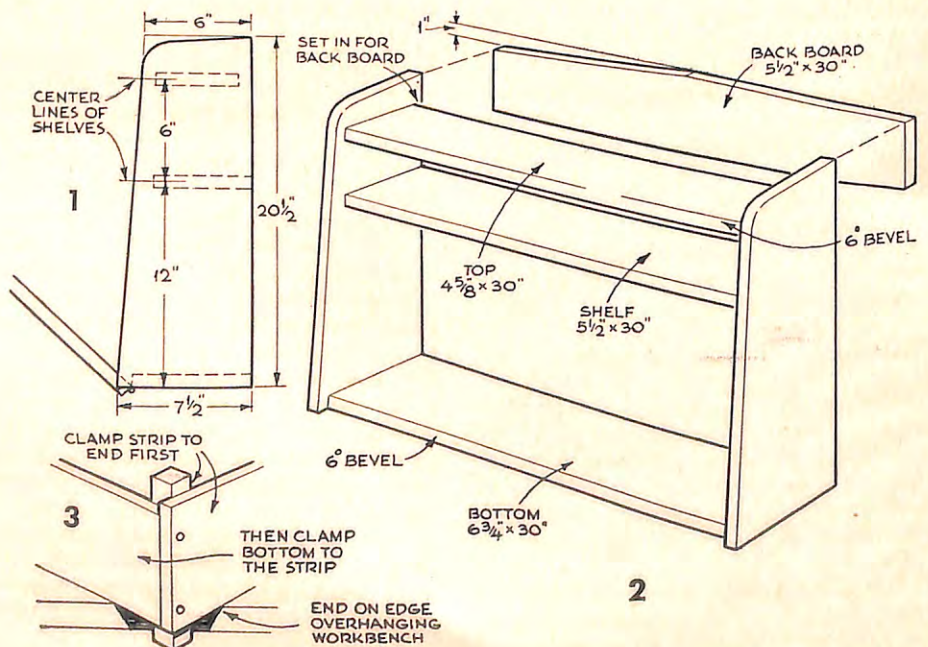

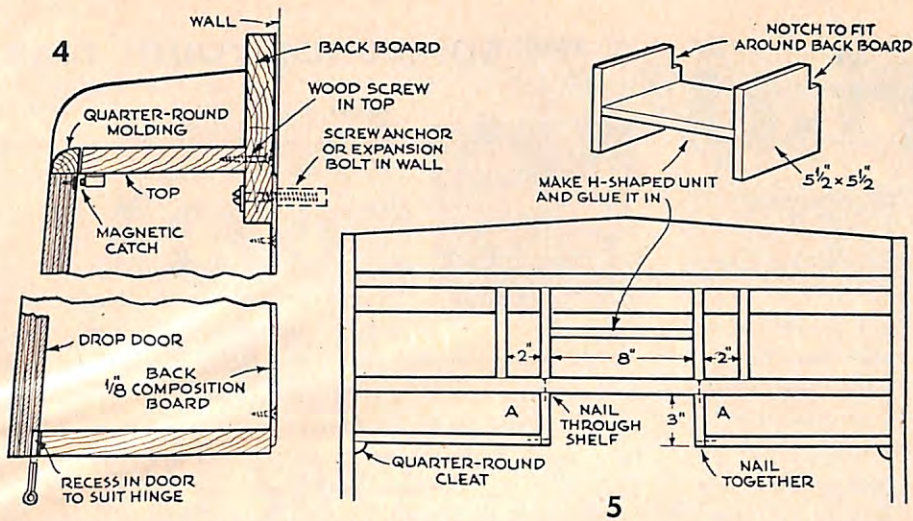

of wood (about 1" by 1") firmly to an end, and then clamp the other member to this strip as shown in Figure 3. By lining up the parts this way and then drilling the holes, you can be sure they will be properly aligned when assembled.

Drill dowel holes 2" deep, and cut the dowels 1 3/4" long. The 1/4" gap gives trapped glue a place to go. For wood screws, drill the pilot hole through one part into the other, open it up to the body size of the screw to a depth of 1", and countersink well. A bit of tape stuck on the drills at the proper spot serves as a marker to keep you from drilling too far. Better still, of course, is a combination wood-screw drill that makes the pilot and

saw. If dowels protrude only a little, a saw will not take hold. They can be dressed flush with a block plane or a power sander.

Use glue to reinforce the joints even if you assemble them with wood screws. In any case, check the frame for squareness before the glue sets. If you haven't a big carpenter's square, simply take the diagonal measure from corner to corner. If the two diagonals are equal, the case is square. If they aren't, cautiously pull together the corners that give the longer diagonal measurement. Hold them in position with a strip of wood tacked diagonally across the back edges of the case.

FITTING THE DOOR. For a wood-grain finish, use lumber-core veneer plywood. For a paint or enamel finish, fir plywood will do. The upper edge of the door is trimmed with a piece of quarter-round molding that conceals the plies.

Since the case may be slightly out of square, it's a good idea to lay the door stock in front of it and scribe your cutting lines on the stock by running a pencil along the inside of the ends. Saw carefully to the lines, using a fine-toothed blade to minimize splintering.

A piano hinge is ideal but will cost from two to three dollars, whereas a pair of good brass butt hinges runs about 75 cents. The hinge should be recessed into what is the upper surface when the door is down, as shown in Figure 4. Attach two lid supports or foot-long pieces of brass chain to hold the door horizontal in the writing position. A magnetic catch is desirable to prevent it from falling open accidentally. Mount the magnet under the top and the catch plate in a shallow recess in the inner door face.

THE INSIDE FITTINGS should be made of solid 3/8" or 1/2" wood if possible. The drawing (Figure 5) shows one of many possible arrangements.

The hanging members that support the side shelves (A-A in the drawing) should be glued and nailed to the main shelf before the upper partitions are set in. The side shelves rest on pieces of quarter-round nailed to the endpieces.

Build up the middle shelf and partitions as a unit (Figure 5) and then set

it in place. If made a good close fit, this and the pigeonhole dividers can be glued in without nails. All four partitions will have to be notched to fit around the back board, which extends below the top.

A small drawer or two might be fitted into this middle section. For simple drawer construction, see the spice shelf in *The Elks Workshop* for July, 1955. (If you don't have a copy, write to *The Elks Magazine*, 386 Fourth Avenue, New York 16, N.Y., enclosing three cents to cover postage, and a copy will be sent without charge).

A back of 1/8" thick hard composition board can be attached with countersunk No. 4 wood screws as shown in Figure 4. Cut this piece 1/2" smaller each way, so that it is set back from the case 1/4" all around. This will make the edges of the composition board invisible.

FINISHING THE DESK. Many excellent wood-grain finishes stain and seal the wood in the same operation (tung-oil sealer, stain waxes and varnish stains are among these). For a paint or enamel finish, prime the wood with thinned shellac or varnish and follow with one or two coats of good enamel, or even interior paint.

Run 1/4" mounting screws through the heavy back board (not the 1/8" board only) into wall studs. Use screw anchors or expansion bolts in plaster or masonry walls.

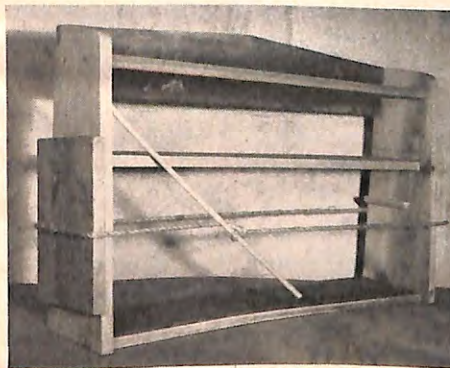

CLAMPING WITHOUT CLAMPS. Dowel joints must be drawn tightly together. If you have no bar clamps, tie a rope loosely around the assembly, stick a dowel through and twist. Insert pieces of wood wider than the ends to prevent the rope from damaging the edges.

body holes, countersink and counterbore all at once.

After drilling, blow chips out of the joints and especially out of dowel holes. Apply a preliminary coat of glue to the end grain of each horizontal member to seal it. Then put on a second coat. Use a small brush to get glue into each dowel hole, and coat the dowels thinly before inserting them.

If cut to proper length, dowels can be driven flush with a block of wood held under the hammer. Should any protrude, wait until the glue sets hard before sawing them flush, and take pains not to scratch the surrounding wood with the

BUY DIRECT FROM-FACTORY **SAVE MIDDLEMAN PROFITS**

MASTER MECHANIC PORTABLE LIGHT PLANTS

(Item 24) Push Button Start—700 watts 115 v. 60 cycle, A.C. Powered by a rugged 2.2 hp. easy starting Briggs gas engine. No wiring necessary. Just plug in and operate. Plenty of current for any radio, television, oil burner, freezer, pump, lights, etc. which require up to 700 watts. Ideal for camp, cottage, trailer or boat. Includes voltmeter and built-in winding to charge 6 v. auto batteries. Wt. 75 lbs. Easily fits in car trunk. Be prepared if storm knocks out power lines. Fully guaranteed. Regularly \$275 **\$143.50** (special)

1200 Watt Plant (Item 45) same as Item 24 but with larger generator & engine—50% greater output. Send for Big 1957 Catalog. Free with order. Prices f.o.b. factory. 10 day money back guarantee. Send check or M.O. Master Mechanic Mfg. Co., Dept. 50-P, Burlington, Wis.

"TOOK IN \$217 FIRST 10 DAYS"

Some make more, some less

We help you to start Your Own All-Year Business Make Big Money! With our easily operated, highly efficient wall washer, Chas. Stelle took in \$217 gross in first ten days. E. L. Goss took in more than \$10,000 in one year. E. C. Taber wrote, "I made \$400 gross in two weeks." And no wonder—this machine washes walls 6 times faster and better than by hand. **Your Money-making Opportunity.** Enjoy independence—freedom from bosses, layoffs. Customers everywhere—homes, offices, schools, etc. Expenses low, profits high. No shop necessary; operate from home. Can start spare time until your full time is available.

Lose no time. Get all facts without obligation

FREE BOOK! MAIL COUPON TODAY!

• VON SCHRADER MFG. CO. •
 • W 24 "W" Pl., Racine, Wisconsin •
 • Send at once (no obligation) your FREE •
 • booklet containing information about your •
 • WALL WASHING MACHINE and how I can start •
 • my own permanent, profitable business. •

• Name _____ •
 • Address _____ •
 • City _____ Zone _____ State _____ •

Editorial

GENEROUS SPIRIT OF ELKDOM



Many activities of subordinate lodges of our Order and its individual members of a charitable and humanitarian character result from the planning and the appeal of Grand Lodge Committees.

The Youth Committee of the Grand Lodge suggests, and to some extent directs, activities contributing to the care and development of our young people.

The Lodge Activities Committee has a multiplicity of suggestions to make to the subordinate lodges relative to charitable and humanitarian activities.

All Grand Exalted Rulers make suggestions to the lodges for projects of this character. As a result of these Grand Exalted Ruler appeals and suggestions of the several committees of the Grand Lodge, the Order has materially increased its contributions of funds to, and work on behalf of, many worthwhile movements. This has not only given members a great deal of satisfaction but has developed a nationwide appreciation of the high character of the services and performances of our Elkdom.

Even the Elks Spirit of Christmas, strong and spontaneous as it is, cannot fail to be additionally inspired and quickened by the strong appeal of the Grand Exalted Ruler for Christmas recognition that appears in this issue.

While Christmas is generally regarded as a religious celebration, the practices it emphasizes have been adopted by people generally regardless of religion.

While it is of Christian origin, it has, at least in this country, gained a recognition and observance by millions who worship God through the teaching and practices of other faiths.

It has been said that at Christmas everyone seems happy, acts kindly, smiles pleasantly, and it has been asked why such cannot be their attitude throughout the year.

We like to feel the Elks, naturally and fully, possess year around the spirit of peace on earth good will to men, which the angels sang to the shepherds when Christ was born.

The Christmas spirit and special Christmas giving is, for the Elks, a culmination of kindly thoughts and deeds of preceding months.

Sometimes we wonder if this year around kindly attitude of the Elks does not come to us from our theatrical founders, men who knew much about the ups and downs of life and who wrote the word "benevolent" into the name of the Order to which they gave birth and character.

The Elks have a faculty of giving with a smile and spirit as far as possible removed from what John Boyle O'Reilly referred to as:

"Organized charity, scrimped and iced, in the name of a cautious, statistical Christ."

It is not necessary that an Elk go through the experiences of a Scrooge before it can be said of him as it was of that Dickens character:

"He knew how to keep Christmas well."

THE COMMUNIST YOUTH TRAP



Last month in this space we warned that the communists are concentrating efforts on corrupting youth with their debasing ideologies. The warning was timely, for now Moscow has invited the youth of the world to attend a "youth festival" in the blood-red communist capital in July and August of

1957. So, we repeat the earlier warning, and add: Make sure that no boy or girl in your community is hoodwinked by this latest move by hangman Stalin's bosom friends to lure youth from the green pastures of freedom to the sere barrens of the Commie paradise.

The Reds have set a clever trap and baited it well. First, it is billed as non-political. The announcement states that the festival "is open to all youth, irrespective of their convictions, race, religious beliefs or nationality. No political, philosophical or other tendencies will prevail at the festival. The festival will be held in the spirit of mutual respect and understanding, in the spirit of the youth of all countries." With that broad-minded, open-hearted attitude in mind, listen to this: From a "special International Festival Fund", the Reds will gladly pay the expenses of any youngster who would like to visit Moscow but lacks money to make the trip.

As "Freedom's Facts," a publication of the All-American Conference to Combat Communism, points out, "In this age of relaxed international tensions, how could an adventurous youngster turn down such an appeal?"

Promoting the festival is the World Federation of "Democratic" Youth, which, as "Freedom's Facts" states, is one of numerous international Commie fronts set up after World War II to pave the way for communism throughout the world. And naturally, the miserable creatures who make up the Commie "party" in this country are beating the drums for the festival.

Note how the Reds throw the word "democratic" around in their titles. They do it because they want the rest of the world to believe that communism is just another form of democracy, and therefore there's really no big difference between us, don't you know. Our relentless exposure of communism's record will expose the communist lie of their distortion of democracy.

Similarly, with their phony youth festival, the Reds want boys and girls, who were brought up to believe that the Ten Commandments are God's laws which men violate at their peril, to treat with "mutual respect and understanding" the communist teachings that there is no God but the state, that religion is a lie, that it's perfectly all right to torture and murder millions of human beings if it will advance the cause of communism.

We don't swallow that line, either. On the contrary, our youth should be firmly schooled in just what communism is and always will be, and instructed that to respect communism is to respect evil.

We hope that if the drum-beaters for the phony youth festival get busy in your community, the Elks will nail their propaganda promptly and effectively as another attempt by ruthless men to use the bright dreams of youth to plunge the world into the nightmare of communism.

Direct-to-You



FACTORY SALE

SAVE 50% AND MORE

ELECTRIC INFRA-RED *Oven Toaster*

Does Everything!
Bakes a Complete Meal

IT TOASTS
IT GRILLS
IT BROILS
IT BAKES



Gleaming
COPPERED
and
ALUMINUM
FINISH



BIG
Slide Out
Tray and
Rack

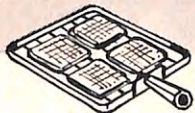

Wonderful for Frozen
Waffles and Pancakes



Grills and Broils
Everything



Toasts Bread, Rolls
Coffee Cake Perfectly

LIST
PRICE
\$14.95

\$ **3.95**

NOW YOU CAN MAKE OVEN-TOASTED FOODS RIGHT AT YOUR TABLE

Time-saving! Easy to use! Here's a toaster, an oven and a grill all in one wonderful unit. Heats instantly . . . cools quickly and does not overheat the kitchen. Cooks food with the marvelous tangy "outdoor" tastiness easily and quickly in the kitchen or at your table. Cooks the penetrating infra-red way that seals in all juices and flavor. Has cool Bakelite feet and handles so as not to scorch your table or burn your fingers. Prepares eggs, grills bacon, sausages or ham. Doubles, too, as a regular broiler for juicy, tender steaks, chops, chicken and fish. Wonderful for hamburgers, hot-dogs and made to order for frozen foods. Big—toasts 4 sandwiches at one time. A joy to own . . . a thrilling idea for a thoughtful, useful gift!

NIRESK INDUSTRIES, Inc. • CHICAGO 40, ILL.

Direct-to-you at much
less than wholesale

MONEY BACK GUARANTEE

Niresk Industries, Inc., Dept. HAA-1,
4757 Ravenswood Ave., Chicago 40, Ill.

Please rush at once \$14.95 list price Oven Toaster at a total cost to me of only \$3.95. If I am not 100% delighted I can return for a prompt refund.

TO SAVE POSTAGE
I enclose \$3.95.

SHIP C.O.D. I will pay
postage and C.O.D. charges.

NAME _____

ADDRESS _____

CITY _____ ZONE _____ STATE _____

"I've tried 'em all. It's Camels for me. They taste just right and they're real easy to get along with, pack after pack."

Herman Kitcher
DOCUMENTARY FILM CAMERAMAN

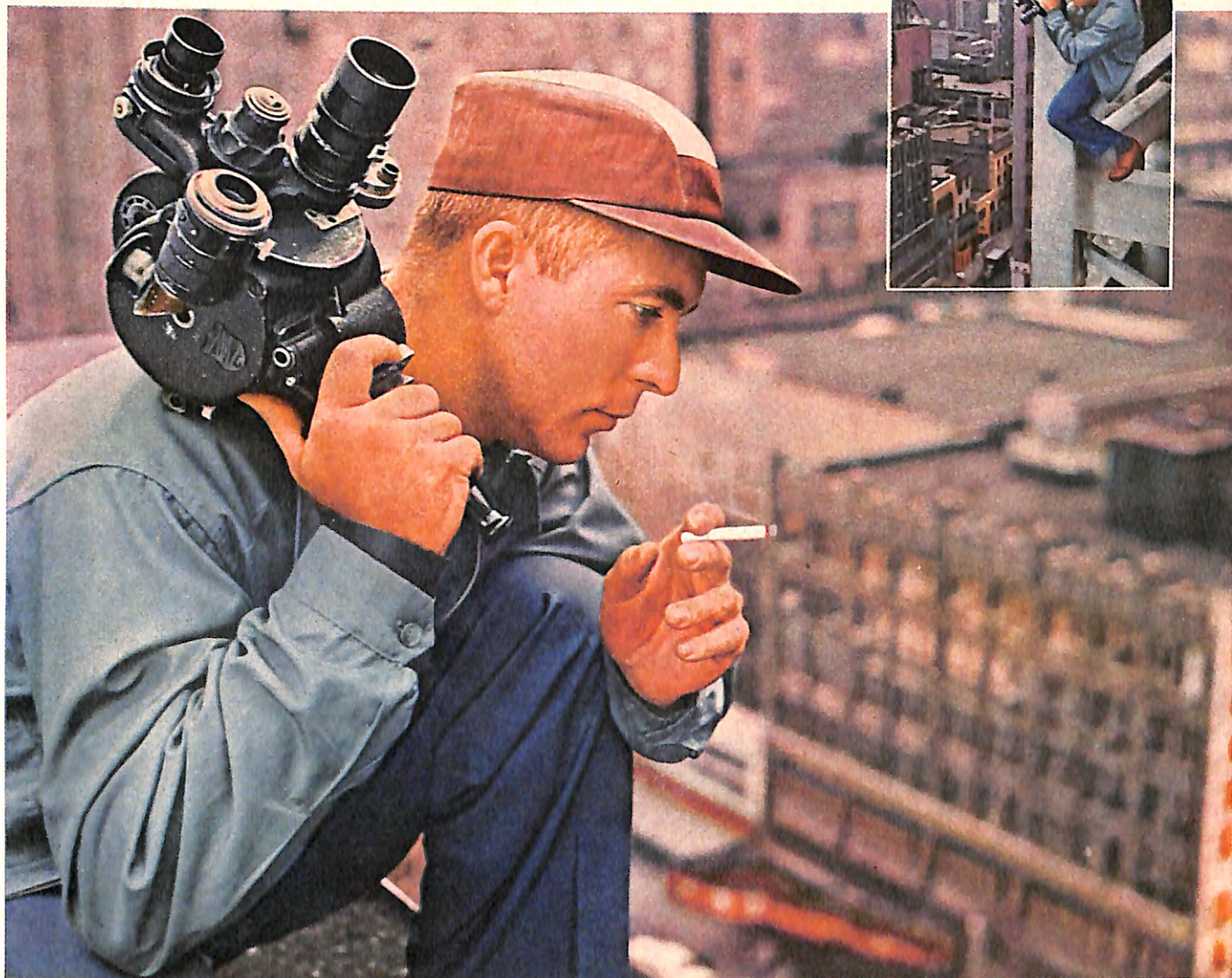

R. J. Reynolds Tobacco Co., Winston-Salem, N. C.

HAVE A REAL CIGARETTE

...have a Camel!



Discover the difference between "just smoking" and Camels!

Taste the difference!

Camels are full-flavored and deeply satisfying — pack after pack. You can count on Camels for the finest taste in smoking.

Feel the difference!

The exclusive Camel blend of quality tobaccos is unequalled for smooth, agreeable smoking. Camels are easy to get along with.

Enjoy the difference!

Try today's top cigarette. You'll see why more people smoke Camels, year after year, than any other brand. They've really got it!