

THE

Elks

W

MAGAZINE

FEBRUARY 1957

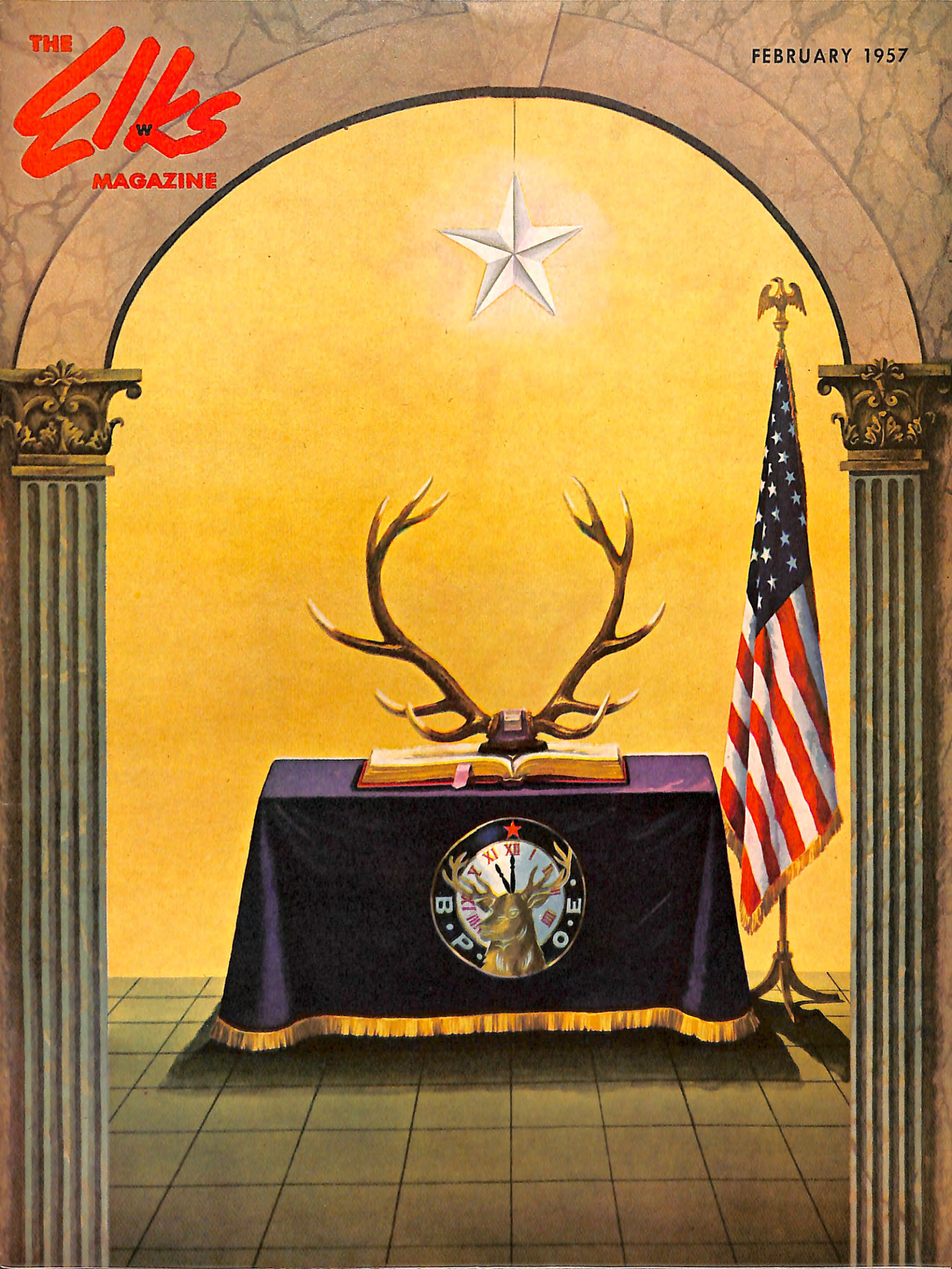

F A M O U S *Monte Carlo* STAINLESS STEEL STEAK KNIVES

NATIONALLY
ADVERTISED
AT \$2.00

33¢ EACH

- 10 Year Replacement Guarantee!
- Serrated Edges!
- Hollow Ground!
- Never needs sharpening!
- Gold and Ivory Hue Handles!

Greatest cutlery bargain we have ever offered! The very same stainless steel steak knives advertised in "House Beautiful" magazine for \$2.00 each—now price slashed to just 33¢! This drastic price reduction is possible only because of our tremendous buying power plus the magic of the American dollar abroad!

These exquisite Monte Carlo knives are made of the finest Korium stainless steel by old world craftsmen right in Solingen, West Germany—the cutlery center of all Europe! Blades won't rust, tarnish, chip, or crack. They never need polishing. They are hollow ground like a barber's razor, with minutely serrated edges for finer, faster cutting. You'll be amazed how easily they slice through thick steaks, roasts, etc. Handles are finished in a beautiful design of autumn leaves in the rich colors of Gold, handsomely embossed on a background of gorgeous pastel Ivory Styrene. Truly breathtaking to see, to hold, to own! Perfect for any table-setting—period or modern.

All first-quality knives, no seconds or imperfections in the lot! But only Thoresen's, in all America has them. This is one bargain you can't afford to pass up. But act fast—before our entire stock is gone! Rush Coupon below at once! Order 3 for 99¢; 6 for 1.98; or 12 for 3.96 gift boxed. Order by No. 89.

*Finest
Solingen
Steel*

*First
Quality*

FREE GIFT

PRINCESS SERVER
JUST FOR TRYING
THESE
KNIVES!



Rich, ornate, exquisitely designed! Yours FREE on any order for 12 Monte Carlo Knives. You KEEP it free even if you return knives for refund!

MONEY BACK GUARANTEE!

THORESEN INC., Dept. 103-B
585 Water St., New York 2, N. Y.

RUSH the items checked below on 10-day home trial, money-back guarantee. If I'm not completely thrilled, I'll return the merchandise for prompt refund.

Payment enclosed. Rush prepaid. Send C.O.D. plus charges.

No. 50—Salad Maker (4.98)

No. 89—Monte Carlo Steak Knives

Send 3 for 99¢. Send 6 for 1.98. Send 12 for 3.96 gift boxed. Include Free Princess Server.

Name.....

Address.....

City.....State.....

(Canadians: Order direct from our Montreal Plant: 45 St. James St., West, Montreal 1, P.Q.)

SPECIAL! SALAD MAKER

Usually
Sells for
Over
\$10.00

WITH 4
STEEL CUTTERS

LOWEST PRICE EVER!

Only **4.98**
COMPLETE

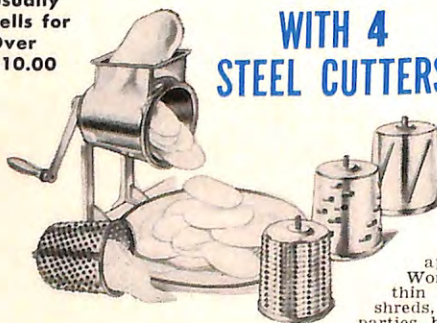

- Slices
- Grates
- Chops
- Chips
- Peels
- Crumbs
- Scallops

This amazing salad maker performs ALL food-cutting operations that any other machine performs. Prepares food in hundreds of tasty, eye-appealing ways. Fast! Easy! Economical! Wonderful for tossed salads, waffle or paper thin potatoes, crums, etc. Wonderful for parties, baby formulas, health foods, juices, etc. Now you need not pay up to \$14.95. Our bargain price for this guaranteed Salad Maker—complete with 4 steel cutters for only 4.98. Quantity limited. Sorry, only one to a family. Order by No. 50.

"Whack the Hell out of the Ball WITH YOUR RIGHT HAND!"

—says Golf Pro Tommy Armour

This is just one of the 11 simple ways in which Tommy Armour's new book guarantees you will play your best golf all the time



**TOMMY
ARMOUR**

He has won virtually every major golf tournament in the world, including the U. S., British, and Canadian Open Championships, the P. G. A., and has gained an even greater reputation as a teacher than he did during his heyday in tournament golf.

IF YOU think golf is a "left-handed" game—try Tommy Armour's advice. "Just hold the club firmly with your left hand and whack the hell out of the ball with your right!"



Approach shots—your greatest chance for improving your golf game. Each shot needs a different stance. Learn what they are.

Tommy ought to know. One of the great tournament names of all time, he has made an even greater name for himself as a teacher. He gives lessons at the sumptuous Boca Raton Club in Florida—to businessmen, celebrities and topflight golfers. The price of his lessons is high. But they have proven to be worth every cent.

Take the case of a business man who was trying to break 90. Armour went around with him and just kept repeating two principles. To everyone's amazement—the business man shot a 79!

Turns Good Golfers into Champs

In 1934, Lawson Little was having a little trouble with his game. Armour said: "Lawson, you have a very good swing—except for one thing. Do this for me." And he told him what to do. Lawson Little captured the British Amateur that year, and the next year, too!

Other golfers—including Frank Stranahan, Babe Didrickson Zaharias, Betty Jameson, Patty Berg—have freely admitted their debt to Armour's keen teaching.

After 25 years, Armour has put this shrewd golf insight into a book. It is called **HOW TO PLAY YOUR BEST GOLF ALL THE TIME**.

In it, Tommy Armour has cut away all the frills and theories. He gives you specific ways in which most any golfer can cut from 5 to 12 strokes off his average game. Here are just a few of them.

1. HOW TO TEE THE BALL—One little trick that can add 50 yards or more to your drive. And it's an extra safeguard against "dubbing" your drive.

2. DON'T WASTE YOUR GREATEST SOURCE OF POWER—Really whale into a shot with your right hand and be amazed how much more distance you get. It's all in how you use your hands—and WHEN.

3. IS YOUR GRIP RUINING YOUR GAME?—It's amazing how much you can improve your game just by looking at your palm before gripping the club.

4. STOP WORRYING ABOUT SHOULDER AND HIP ACTION—Armour shows you how you can forget about this entirely, be more relaxed, and get more power in your shots.

5. DO YOUR FEET GET IN THE WAY?—Let Armour show you a simple way to be sure your footwork is always correct.

6. ARE YOU WORKING TOO HARD TO GET POWER?—Many golfers almost tear themselves in half trying to get power into a swing—and fail miserably. Yet the real power in your swing doesn't come from the body at all.

7. EASY WAY TO GET OUT OF A SAND TRAP—Shows you how simple it is to get out of a trap the first time.

8. DO YOU TAKE YOUR WAGGLE SERIOUSLY?—The old Scotch saying goes: "As ye waggle so shall ye swing." But even good golfers who have developed excellent waggles often make one serious mistake that nullifies all their good work.

9. WHAT HAPPENS AT THE TOP OF YOUR BACKSWING?—A brief second at the top of your backswing can greatly improve the timing of most golfers. Armour shows you how to make the most of that split second.

10. HOW TO GO AROUND IN 30 PUTTS—One simple tip that will help cut down on "muffed" putts.

11. WHERE MOST GOLFERS RUIN THEIR GAME—Your greatest chance of saving strokes comes in your approach game. Armour tells you how to get up on the green surely and easily.

The book covers much more, of course. Each chapter is like a personal lesson.

Armour gives you a clear, uncluttered picture of just exactly what you have to do to play better golf. Anything that is involved, complicated, and confusing has been shaved away.



SEND NO MONEY

Mail Coupon on This Double Guarantee

The publishers of this book are so sure it can help you take 5 to 12 strokes off your game they are willing to send it to you on this double guarantee. Mail coupon below for 10 day's free examination of **HOW TO PLAY YOUR BEST GOLF ALL THE TIME**. If just reading the book doesn't make you feel that you can play a better game—return the book and owe nothing. Secondly, if you don't actually shave 5 to 12 strokes off your game in accordance with the guarantee chart, you can THEN return the book for full refund. Mail coupon at once to **SIMON AND SCHUSTER, Mail Order Dept. 94, 630 Fifth Ave., New York 20, N. Y.**

Do you make a certain, simple mistake at the top of your swing? It causes most of the slicing, hooking, topping, hitting under, missing.

GUARANTEE (See coupon at bottom)

If You Now Score	In a Month You'll Score
120	108
105	95
99	90
92	85
85	80

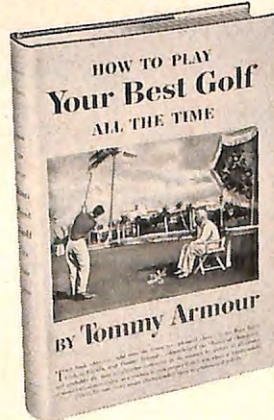

Use this book 10 days free — Mail coupon below

Simon and Schuster, Publishers, Mail Order Dept. 94
630 Fifth Avenue, New York 20, N. Y.

Please send me—for FREE examination—Tommy Armour's brand-new book, **HOW TO PLAY YOUR BEST GOLF ALL THE TIME**. If just reading the book doesn't make me a more confident golfer, I may return it in 10 days and owe nothing. Otherwise I will send \$2.95, plus few cents postage, as payment in full. But I can still return the book for a refund of my \$2.95 if—within one month—I fail to reduce my score as indicated in the guarantee chart above.

Name.....

Address.....

City..... Zone No. (if any)..... State.....

SAVE POSTAGE CHARGES. Check box if you prefer to enclose \$2.95 WITH this coupon. Then WE will prepay all postage charges. Same double guarantee and refund privilege applies.

Railroads have
changed since 1830...



but the good taste
of **TEACHER'S**
never changes!

TEACHER'S
HIGHLAND CREAM

86 PROOF • Blended Scotch Whisky
Schieffelin & Co., New York

THE ELKS

VOL. 35

MAGAZINE

No. 9

NATIONAL PUBLICATION OF THE BENEVOLENT AND PROTECTIVE ORDER OF ELKS OF THE UNITED STATES OF AMERICA. PUBLISHED UNDER THE DIRECTION OF THE GRAND LODGE BY THE NATIONAL MEMORIAL AND PUBLICATION COMMISSION.

THE ELKS NATIONAL MEMORIAL AND PUBLICATION COMMISSION

JOHN S. McCLELLAND
Chairman

EMMETT T. ANDERSON
Vice-Chairman

JAMES T. HALLINAN
Treasurer

WADE H. KEPNER
Secretary

JAMES R. NICHOLSON
General Manager

LEE C. HICKEY
Editor

REGINA M. FISHER
Associate Editor

JOSEPH C. JONES
Art Editor

GENEVIEVE G. CONOVER
Advertising Production

W. H. MAGRATH
Controller

JOHN SCHMITT
Circulation Manager

EDWARD FAUST
Promotion Manager

EDITORIAL OFFICES, 386 Fourth Avenue, New York 16, N. Y.

CONTENTS FOR FEBRUARY, 1957

COVER BY ALLEN SAALBURG

(Refer to Page 42)

NORTH RETURN	<i>William Byron Mowery</i>	4
NEAR EAST—What Is Behind the Israeli-Arab Conflict?	<i>Robert Aura Smith</i>	6
LODGE VISITS OF FRED L. BOHN		8
ROD AND GUN	<i>Dan Holland</i>	10
A MESSAGE FROM THE GRAND EXALTED RULER		11
LEATHER LULLABY	<i>Robert Turner</i>	12
NEWS OF THE LODGES		14
FOR ELKS WHO TRAVEL	<i>Horace Sutton</i>	18
AN "OPERATION EUROPE" REPORT		20
ELKS FAMILY SHOPPER		24
TOM WRIGLEY WRITES FROM WASHINGTON		30
TRAVELGUIDE		32
A TIMELY WARNING FROM FRED L. BOHN		34
OUR FEBRUARY COVER		42
FREEDOM'S FACTS		49
ELKS WORKSHOP	<i>Harry Walton</i>	50
EDITORIAL		52

CHICAGO 1
360 North Michigan Avenue
STATE 2-6662



ADVERTISING OFFICES

NEW YORK 16
386 Fourth Avenue
MURRAY HILL 4-5495



LOS ANGELES 17
1709 West 8th Street
DUNKIRK 8-5187

SAN FRANCISCO 4
927 Mills Building
EXBROOK 2-4073

PORTLAND 4, ORE.
217 Times Building
CAPITOL 7-3718

CHANGE OF ADDRESS: POSTMASTER—Please mail Form 3579 notices to: THE ELKS MAGAZINE
386 Fourth Avenue, New York 16, N. Y.

Members are asked, in changing address, to send this information (1) Name; (2) Lodge number; (3) Membership Number; (4) New address; (5) Old address. Please allow 30 days for a change of address to be effected. THE ELKS MAGAZINE, Volume 35, No. 9, February, 1957. Published monthly at McCall Street, Dayton, Ohio by the Benevolent and Protective Order of Elks of the United States of America. Entered as second class matter November 2, 1949, at the Post Office at Dayton, Ohio, under the Act of August 24, 1912. Acceptance for mailing at special rate of postage provided for in Section 1103, Act of October 3, 1917, authorized May 20, 1922. Printed in Dayton, Ohio, U.S.A. Single copy price, 29 cents. Subscription price in the United States and its Possessions, for Elks \$1.00 a year; for non-Elks, \$2.00 a year; for Canadian postage, add 50 cents a year; for foreign postage, add \$1.00 a year. Subscriptions are payable in advance. Manuscripts must be typewritten and accompanied by sufficient postage for their return via first class mail. They will be handled with care but this Magazine assumes no responsibility for their safety. Copyright, 1957, by the Benevolent and Protective Order of Elks of the United States of America

ELKS NATIONAL FOUNDATION



"The Joy of Giving"



Exalted Ruler Anthony M. Cardarell of Quincy, Mass., Lodge, presents an Elks National Foundation grant of \$700 to Miss Bernice R. Lyman, West Quincy, as a helpful aid in completing a four-year course of training at Boston University as a specialist in cerebral palsy therapy. This was the fourth award that Miss Lyman has received from the Foundation, making a total grant over the four-year period of \$2,700.

An Elks National Foundation tuition grant enabled Mrs. Rose Louise Widner of Hutchinson, Kansas, to attend Syracuse University, and at the Allen School in Hutchinson she presently is teaching a class of orthopedically handicapped children who are victims of cerebral palsy.

In the picture below, Mrs. Widner is shown with a group of children that she is helping toward a better life. "All of the children are progressing satisfactorily,"



Mrs. Widner wrote to Chairman Malley recently, saying, "the class has been well accepted by the people of the community. Again I thank you for the Elks National Foundation Grant."

For some time, Past Grand Exalted Ruler John F. Malley, Chairman of the Elks National Foundation, has urged attorneys who are members of the Order and who are doing estate work, to keep the Foundation very much in mind for bequests since the Principal Fund provides a means of making an enduring gift.

During the past few years there have been several important bequests and Mr. Malley advises that on November 19th United States Government Bonds valued at approximately \$45,000 were received as a partial distribution of the Nathan O. Noah Estate. Mr. Malley expects that the balance of the Estate will be turned over to the Foundation Trustees before the end of January, although the value of the balance is not known definitely, since a portion of the securities is presently held in the Philippine Republic.

Brother Noah was a resident of Tucson, Ariz., at the time of his death and bequeathed the bulk of his estate to the Foundation to establish the Nathan O. Noah Scholarship Trust Fund.

Miss Leslie B. Remick, Wakefield, Mass., who was sponsored by the local Lodge, has been awarded a \$750 Elks National Foundation Fellowship for her junior year at the Boston School of Occupational Therapy.

EASIEST TO USE!

OF ALL OPEN-FACE REELS



Shakespeare WONDER-SPIN

Easiest to use of all open-faced reels — eliminates clumsy wire bail—nothing exposed to foul the line. Four to one gear ratio, level wind; click control on side plate makes crank non-reversing. Metal ring instantly adjusts the smooth drag. No. 1785 with 200 yds. 6 lb. line.....\$23.95 Also No. 1780 (150 yds.)...\$18.95

"Touch-and-Go"

FINGERTIP OPERATION

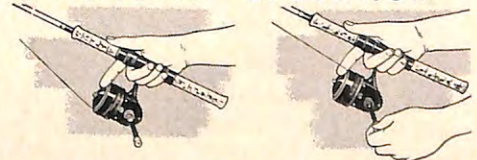

Almost automatic—only two simple motions: Touch the face of the reel, then back up the crank, the line automatically falls against your fingertip . . . and you're ready to cast.

5 BRAND NEW FISHING BOOKLETS AND CALENDAR FREE

Latest in fishing tips and tricks by the experts. Covers spinning, bait casting, push-button, fly and salt water fishing. Send today!



SHAKESPEARE COMPANY Dept. E-2, Kalamazoo, Michigan

Please send me your 5 brand new fishing booklets and calendar, free!

NAME _____

ADDRESS _____

CITY _____ ZONE _____ STATE _____

NORTH RETURN

BY WILLIAM BYRON MOWERY

**The dreaded carnival cage was behind the wolf
Katokah, but now civilization was at his heels.**

UNDER THE STARS of that October night, the big young wolf called Katokah had paused on a high, rocky hill, lost and bewildered, and was trying to get his bearings. With pursuit hot on his heels, he was searching for some direction, some route of escape, that would take him out of danger and on to refuge in some wilderness. Safe only for the moment, he was standing on the bald granite crown of the hill, monitoring the night wind with his nose and looking out across the dark, alien country around him.

Five miles down the farm valley stretching southward he could see the clustered lights of the little town he had just fled from, and faintly he could hear the distant blare of the hated carnival show which had been lugging him about the Midwest all that summer.

A cage door left unlatched for one careless moment—and he had been out like a tawny flash and gone like a tawny ghost.

After the endless months of being prisoner in the steel-wire cage, the ecstasy of freedom was running fiercely in his lean, powerful body. After the fumes and smells of the half a hundred small towns that the carnival had visited, the clean, familiar scent of woods, rocks and earth was heady and exhilarating. And after the noisy, staring tent crowds and the barker's "Hur-ree, hur-ree, hur-ree—See the fee-rr-ooo-cious, the one and only—Katokah the Killer—the Man-Eater Wolf," the night song of owl and katydid and the sigh of wind in the cedars were sweet to his ears.

A mile back down the long timbered slope he could hear a motley pack of farm dogs loud on his trail, as they worked their way up through the scrub oaks and second-growth pines toward the rocky knob where he had halted. The different-noted yaps, barks and baying told him that his enemies numbered a good dozen. On his flight from the carnival show and town, the dogs at the farmsteads he had passed had all been stirred to a frenzy by the dread wolf scent. None of them would have had the boldness to close in on him alone, but a pack had started collecting and had grown, and now they felt strong enough, a dozen to his one, to give him battle.

In spite of the on-coming menace of collie, cur and hound, Katokah resolutely stood his ground on the pinnacle rock, sorting out the different odors on the wind for a clue to where he could turn, where he could find safe haven. But for a while his questing was fruitless and empty. Plain to his eyes and plainer still to his far-reaching, masterly nose, the country all around him was a tamed and settled land, of towns and factory cities, of plowland, dairy ranges and mining regions, with only a few scattered remnants of woods here and there on the hill chains. And nowhere the deep, sheltering wilderness that he sought.

A silver tawny in color, with a sheen of dark on his ears and down his back, the young wolf stood nearly hip-high to a man, and for all his leanness he scaled over a hundred and twenty pounds. An expert on the wolf tribes would have recognized him as coming from the northmost woods and lower Barren Grounds of Keewatin, and would have smiled at the barker's spiel and the garish posters depicting Katokah as dangerous. For in all the history of that Hudson Bay country, from the fur *voyageurs* to the prospectors with Geiger and scintillator, not one of Katokah's vanishing, man-shy breed had ever attacked or menaced a human being.

As he stood there trying bewilderedly to orient himself, he was aware that somewhere under the stars and sliver of moon there was a land of summertime glistening lakes and perpetual sun, of bracing winter cold and endless leagues of snow; and the want tugged at him to get back to that land where he had been whelped and had lived for one round of the seasons. But where that country lay and what course would take him there—that he had not yet studied out.

The memories that came flooding back, as he probed the cool night wind drifting down across the latitudes, were a strange mixture of good and evil. Dimly he remembered the whelping den on a sunny, open ridge, his litter mates, the parent wolves that brought meat to their bairns and protected them from wolverine, fox and bear. And the evil day when the two parents lay dead in the Eskimo grass from the "wolf bane" that a trapper had



ILLUSTRATED BY BOB KUHN

Like the trained fighters they were, the Wolfhounds came at Katokah from three sides. But he was wise to that tactic.

salted a caribou carcass with. And then his hungry wandering along that den ridge, slowly starving, his litter mates perishing one by one, till a kindly prospector happened to hear his diminutive howling and came and captured him.

At the river-bank cabin the big prospector of the booming voice had "breathed on his nose" so that he would ever afterward be tame and companionable, and had named him Katokah, the Swift One.

All his memories of that summer, fall and winter of partnership with the big hardrocker were pleasant and sunlit. But then again came evil days, just after the spring break-up, when his master lay sick in the cabin and the trapper visited there to cadge some "elementaries"—salt and flour, tea and tobacco—as he was all the time doing. Shrewdly calculating that Katokah's great size and the tricks he'd been taught made him more valuable than a dozen wolf pelts and bounty ears. (Continued on page 44)

NEAR EAST

what is behind the Israeli- Arab conflict?

BY ROBERT AURA SMITH

THERE can be no peace in the Near East—and in the world—unless and until the Arabs and the Israelis compose their differences and reach a permanent settlement.”

That statement was made, with only slight modification in language, by six different delegations at the current session of the United Nations. They obviously agree that the problem is acute. There is not a general agreement on how it ought to be solved.

Our concern, here in the United States, is real. It is not just that a part of our population has a stake in Israel. It is rather that our whole population has a stake in world peace. Our influence will have to come into play, perhaps decisively. For that reason it is wise for Americans to understand as fully as possible the nature of the conflict and the issues that are involved. To do this, it is necessary, first

of all, to get the present strife into some sort of historical perspective.

This is not too difficult. The story of Israel, and the Arab-Jew warfare, divides readily into three major phases. There is first, the period prior to the First World War. Second is the period between the wars when Palestine was a British mandate. Finally, there is the present and continuing period in which Israel is the problem of the United Nations and of the world.

For a number of centuries before the First World War Palestine was simply part of the Ottoman Empire. It was rather loosely misgoverned by a succession of pashas installed by the Turkish Sultan. It was in no sense a “Jewish state”. The Jews, in their great dispersal (the Diaspora), had gone to all parts of the world long before this. A British official, in 1850, estimated that there were fewer than

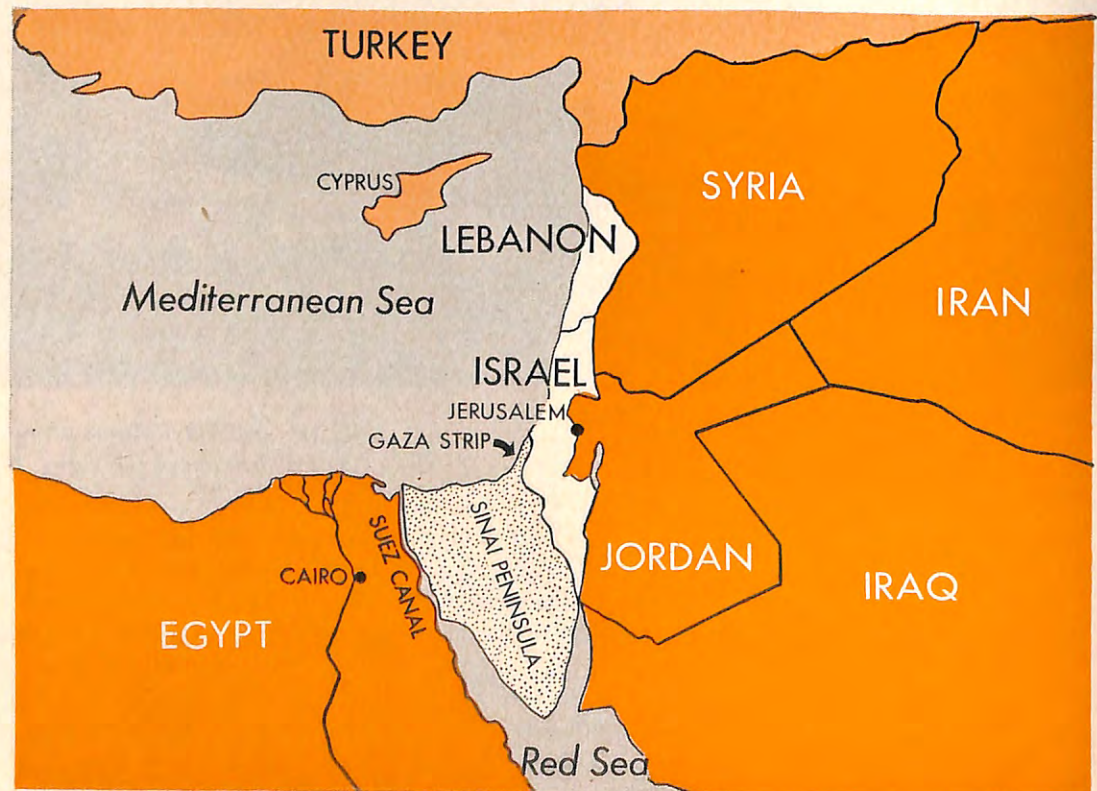

United Press Photo



50,000 Jews in Palestine. The first good census, as late as 1922, showed the Jewish community as only 84,000.

The country, however, had always been a matter of international concern. It was the "Holy Land", not merely for the Jews but for the Christians and Moslems as well. It was the objective of crusades. Orders of knighthood put Jerusalem under their special protection. It was impossible for a "Westerner" to live there and unsafe for him to travel there, but the interest remained.

This was changed, to some extent, early in the last century. An Albanian soldier of fortune, Mehmet Ali, had installed himself as the Pasha of Egypt and from that position he invaded and ruled Palestine in open revolt against the Turks, to whom he was nominally subject. Under his rule and that of his gifted son, Ibrahim, Palestine was opened up to the western world. The "holy places" were no longer inaccessible. It was even safe to travel.

Britain was the first to respond. The first British consul in Palestine was appointed and took his post in 1838. The French, Prussians and Russians were more cautious. They opened their offices in neighboring Damascus. Thus Britain became, from very early, the spearhead of Western influence and the spokesman for Western interests.

This was important. By 1850 there was a stirring among the Arab population. It took the form of antagonism toward the Jews, with stories of ritual murders, but it was also anti-Christian and anti-Western. It was British influence that protected both the Jews and the Christians and the movement died down.

In the second half of the century two other factors came into play. The first was the beginning of "Zionism" as a worldwide movement, and the second was the German drive to the Middle East.

It is necessary to understand "Zionism" because so many of the things wrapped up in it have been confused by other issues and, sometimes, by mistakes of the "Zionists" themselves.

The roots go deep in tradition and his-

tory. This was the "Promised Land." Accordingly, there grew up a plan to return to the shores of the eastern Mediterranean some of those large numbers of Jews who had long since been scattered all over the world. The idea may not have been sound, politically. It had its drawbacks, economically. But religiously and emotionally it was irresistible.

The first Zionist colonies in Palestine were set up in 1885. They flourished. These were dedicated settlers, much like those who conquered the American wilderness. The fact that it could be done gave vitality to the Zionist movement all over the world.

The German drive had quite different origins. Its object was to gain control of the Turks, and through them to get a highway to the Near and Far East. It had two immediate results. The first was to put the British into opposition against this expansionist movement and thus to make the Middle East a battleground for the coming World War. The second was to bring about a reorganization of the government of Palestine, in which Britain had an interest. The Turks created the "Sanjak of Jerusalem", under a special regime. Because of Western pressure one of the important objectives in this move was to protect non-Moslems, that is, Christians as well as Jews, in the administered area. The Germans, at this stage, wanted no part of a "holy war."

Meanwhile, however, quite another element had come into the picture. This was the rise of Arab nationalism. It was directed originally against the Turks, not the British or the Jews. The Arab states had had this loosely organized system of pasha government, and their rulers had done rather well under it. But in 1908 the "Young Turks" made themselves felt. They wanted a stronger, more unitary, state and the Germans egged them on. The Arab chiefs became restless.

It was into this situation that the British stepped, decisively. They backed the "nationalist", that is anti-Turkish, aims of the Arabs. In the celebrated McMahon-Hussein correspondence (1915-16), they

committed themselves to Arab aspirations. Then came the "Revolt in the Desert".

In 1918 General Allenby's forces marched into Jerusalem and Damascus and an era had ended. What to do with Palestine was a new problem.

Two big things happened. Great Britain was commissioned by the League of Nations to take over the Palestine Mandate. And meanwhile, the British Prime Minister, Lord Balfour, had formally declared that Palestine was to be a "national homeland" for the Jews.

This "Balfour Declaration" is so important, and so often misquoted or misrepresented, that it should be seen in its entirety. Here is exactly what Lord Balfour said, in a formal letter to Baron de Rothschild, on Nov. 2, 1917:

"I have much pleasure in conveying to you, on behalf of His Majesty's Government, the following declaration of sympathy with Jewish Zionist aspirations which has been submitted to, and approved by, the Cabinet.

"His Majesty's Government views with favour the establishment in Palestine of a national homeland for the Jewish people, and will use their best endeavours to facilitate the achievement of this object, it being clearly understood that nothing shall be done which may prejudice the civil and religious rights of existing non-Jewish communities in Palestine, or the rights and political status enjoyed by Jews in any other country."

At the time, and on the face of it, such a declaration was unequivocal. The Zion-

(Continued on page 33)



Lodge Visits of FRED L. BOHN



Visiting dignitaries and lodge officers present at the dedication of Hightstown Lodge No. 1955 on November 14th were, from left: Past Exalted Ruler W. Cecil Daley, Harry Cohen, John Perrine, Joseph Corse, Timothy Kelty, Jr., Theodore Greczyn, Jr., David Irvin, Norman Smith, Jules Levin, Member Grand Lodge Ritualistic Committee William R. Thorne, Roman Sitko, Member Grand Lodge Activities Committee Joseph F. Bader, Grand Exalted Ruler Fred L. Bohn, Exalted Ruler Clarence Little, Past Grand Exalted Ruler William J. Jernick, State President Dr. Louis Hubner, District Deputy Walter B. Meseroll, Chairman Crippled Children's Committee Phillip Zelt, State Vice President William Wicks, Charles A. Hotaling, Fred Danser, Jr., Thomas Borden and William Stafford.

MINNESOTA LODGES: Accompanied by Past Grand Exalted Ruler Sam Stern, from October 21st to 24th, Grand Exalted Ruler Fred L. Bohn made several lodge visits in Minnesota.

On October 21st Mr. Bohn arrived at Minneapolis-St. Paul Airport, where he was greeted by delegations from Minneapolis and St. Paul Lodges. The Minneapolis delegation was led by Exalted Ruler Paul C. Hartig and included District Deputy Ernest M. Peacock, former member of the

Grand Lodge Ritualistic Committee John Hafich, Director of Minnesota State Elks Youth Camp G. Freeberg, Past Exalted Ruler W. Howard Comstock and Secretary Stanley P. Andersch.

Included in the St. Paul delegation were Exalted Ruler Laurence E. O'Connor, Jr., member of the Grand Lodge Committee on Credentials William R. Carter, Jr., District Deputy Victor F. Angerhofer and St. Paul member C. E. Mikkelsen. The entire group then drove to downtown Minneapolis,

where Mr. Bohn held a press interview with the Minneapolis "Morning Tribune." That evening the Lodge held a reception and banquet in the Grand Exalted Ruler's honor and Chairman for this event was Brother C. Sutherland. Past Grand Exalted Ruler Sam Stern introduced Brother Bohn.

The next morning Messrs. Bohn, Stern, Carter and Angerhofer were joined by State President Walter Jung, and following breakfast with Brothers C. Sutherland and L. Buldoc of Minneapolis Lodge, the party traveled by airplane to Hibbing, Minn. There they were greeted by Exalted Ruler Adolph A. Ventura, District Deputy Carl A. Carlson, Past District Deputy Chet Nelson, Exalted Ruler Marlin J. Haack of Bemidji Lodge and Exalted Ruler Rudolph Fredrickson of International Falls Lodge. An escort led by Exalted Ruler Lloyd V. Hansen of Virginia Lodge, together with his officers, then drove the group to Virginia for a luncheon meeting for which Brother Donald Wicks was Chairman.

The Grand Exalted Ruler was able to address Brothers not only of Virginia Lodge but also from nearby lodges because for those who were unable to attend the luncheon Mr. Bohn's address was recorded for rebroadcast over the NBC station in Duluth. Following the luncheon the party was joined by Brothers Carlson, Nelson, Haack and Fredrickson and motored to International Falls Lodge, a distance of 100 miles. This was the first visit of a Grand Exalted Ruler to Lodge No. 1599. Mr. Bohn was escorted to the local radio station for a broadcast and that evening there was a large attendance at a banquet held in the Grand Exalted Ruler's honor in the new home of International Falls Lodge.

The following day the official party was joined by Exalted Ruler Phil Prichard of Thief River Falls Lodge, who escorted the group to his home lodge for a luncheon to which local Lions and Rotary Club members were invited. Following the luncheon the group motored to Bemidji, where they were met at the city limits by

Photographed before a striking Northwoods display at Bemidji, Minn., Lodge on October 23rd were, from left: Exalted Ruler Marlin J. Haack, Grand Exalted Ruler Fred L. Bohn, Past Grand Exalted Ruler Sam Stern, District Deputy Carl A. Carlson and State President Walter Jung.



While visiting northern New Jersey on November 15th, the Grand Exalted Ruler inspected New Jersey's Boystown in Kearny and among those accompanying him on the tour were member of the Grand Lodge Activities Committee Joseph F. Bader, District Deputy Richard J. Tobin, State President Dr. Louis Hubner, State Vice-President D. V. Crosta and Past Grand Exalted Ruler William J. Jernick. Father Egan, who is Director at Boystown, is shown in the photograph with Mr. Bohn.



Above: At the banquet tendered the Grand Exalted Ruler by Minneapolis, Minnesota, Lodge on October 21st were from left: Banquet Chairman C. Sutherland, Past Grand Exalted Ruler Sam Stern, Exalted Ruler Dr. Paul Hartig and Mr. Bohn.

the local police together with a delegation from the Lodge. Since Bemidji is the home of the legendary giant lumberjack, Paul Bunyan and Babe, the Blue Ox, Past Exalted Ruler Allen V. Doran arranged for pictures by the statues of this famous hero and his companion. Approximately 240 Elks, their ladies and guests were present at a reception and banquet that evening. For this occasion Brother Larry Lindman arranged an outstanding Northwoods display.

The following morning Brothers Bohn, Stern, Carter and Peacock flew to Minneapolis, where they had breakfast with Robert Newhouse, Past Exalted Ruler of Minneapolis Lodge. The visitation group then bid farewell to the Grand Exalted Ruler for all the grateful Elks of Minnesota as he boarded a plane to fly to his home in Zanesville, Ohio.

NEW JERSEY LODGES: Grand Exalted Ruler Fred L. Bohn landed at Newark Airport at 1:09 p.m. on November 14th. On his arrival, he was greeted by Past Grand Exalted Ruler William J. Jernick; State President Dr. Louis Hubner; Joseph F. Bader, member of the Grand Lodge Activities Committee, and William R. Thorne, member of the Grand

Below: In the Reception Room of the Governor's Office in Trenton, New Jersey, on November 14th were left to right: Colonel Lyle A. Brookover, boyhood friend of Grand Exalted Ruler Bohn and a member of his home lodge in Zanesville, Ohio, Exalted Ruler Carl Hansen, Levi Purdy, State President Dr. Louis Hubner, Frank A. Tracey, Grand Exalted Ruler Bohn, Governor Robert B. Meyner, Past Grand Exalted Ruler William J. Jernick, Exalted Ruler of Hightstown Lodge Clarence Little, Member of Grand Lodge Activities Committee Joseph F. Bader, Secretary of State Edward Patton, Member of Grand Lodge Ritualistic Committee William R. Thorne and Secretary of Trenton Lodge Joseph S. Loth.



Lodge Ritualistic Committee together with Exalted Ruler Charles J. Maguire and a large delegation from Newark Lodge.

Newark Lodge was host at a luncheon to the Grand Exalted Ruler served at the Airport. The Grand Exalted Ruler spoke briefly, thanking the Lodge for its hospitality. He was then driven down the New Jersey Turnpike under a State Police escort to Trenton Lodge, where he was welcomed by Exalted Ruler Carl Hansen, Jr. and

an escort consisting of the local police.

Mr. Bohn was taken to the City Hall at Trenton where he was presented to the Deputy Mayor, Thomas J. Welsh, who presented him with a scroll certifying him to be an honorary citizen of the City of Trenton together with a small gold key emblematic of his continuous welcome to this city.

He was then escorted to the Headquarter
(Continued on page 38)

Conferring with Grand Exalted Ruler Fred L. Bohn at International Falls Lodge on October 22nd were, from left: State President Walter Jung, (Mr. Bohn), Exalted Ruler Rudolph Fredrickson and Past Grand Exalted Ruler Sam Stern.



On October 22nd Grand Exalted Ruler visited Virginia, Minn., Lodge, and present from left, standing: Member of Grand Lodge Committee on Credentials William R. Carter, Jr., District Deputy Victor Angerhofer, Exalted Ruler Lloyd V. Hansen, District Deputy Carl A. Carlson and District Deputy Ernest M. Peacock. Seated are Mr. Bohn and PGER Stern.



Photographed in Iowa City where the Midwinter Meeting of the Iowa Elks Association took place, left to right: State President Robert E. Davis, host Exalted Ruler M. F. Neuzil, Grand Exalted Ruler Fred L. Bohn, Arthur M. Umlandt of the Board of Grand Trustees, and Iowa City Lodge Secretary R. J. Slavata.

ROD & GUN

BY DAN HOLLAND



and Sunday dinner; they took to the hills.

In some of the more remote sections of these islands I understand that the guinea hens are as wild and primitive as they ever were on their native soil, and I also understand that anyone who thinks he can hunt them is welcome to try. I don't know much about this, but I do know something about them in a section of Cuba where I spent a couple of winters. In fact, I know all about them—now.

This part of Cuba is rather intensely farmed and is divided into large plantations, or *fincas*, either growing sugar cane or pasturing Brahma beef cattle, but with scattered banana groves, vegetable gardens and, in the lowlands, rice fields. Here and there, though, are small areas too rocky and hilly to be cleared, and these are still small islands of jungle.

Each plantation, it seems, has its guinea hens, which band together in large flocks. These birds find refuge in the pockets of jungle, coming out only in the evenings to feed in the cane fields and gardens, and all such flocks are jealously guarded by the individual plantation owners. When a visiting sportsman comes out from Havana, for instance, he is taken with great ceremony and hospitality to a rice field to shoot doves, or even into the pasture country to hunt quail, but he doesn't bother the guinea hens. Cubans are enthusiastic hunters, and the plantation owner does shoot some of his guineas occasionally, of course, but—although I soon gathered that they are wary and provide a fast and difficult target—they are not hunted for sport. The guinea hen is the finest eating of all fowl, and the hunt,

although admittedly fun, is strictly for the purpose of supplying the table.

I had heard a lot about guinea-hen shooting, and I wanted to find out for myself if it was as difficult as they said it was. The first winter in Cuba I dropped numerous hints to that effect, some of them fairly blunt. The family of our host's wife had a large *finca* nearby, and by devious means I discovered also that the *finca* harbored a nice bunch of guineas; still, my hints got me nowhere.

The following winter I took up where I had left off. Our host, Ernesto, spoke English well enough, but one thing he obviously didn't know in English was how to issue an invitation to go guinea-hen hunting. In any case, I discussed the subject so much that I soon knew all there was to know about guinea hens in Cuba—I was sure of that—and all I wanted was the chance to demonstrate it.

About the time I had given up ever seeing one of them over a shotgun, Ernesto calmly announced that my dad and I had been asked to go with him to the *finca* that evening to shoot guinea hens. The family was making preparations for a large dinner, he explained, and they wanted as many birds as we could shoot. No hunter could ask for a better order than that.

This was the break I had been hoping for. Cubans respect a good shot, and I knew that if we made a good showing we would be invited back to do our part for the next family dinner.

When we arrived at the *finca*, Ernesto
(Continued on page 42)

Guinea hen flying overhead.

For a reason, Dan has shot his last white guinea hen in Cuba.

GUINEA hens are African birds by ancestry, and as far as I am concerned Africa is where they belong. Their natural range covers a large section of the dark continent where many of them still roam wild and free, just as they have for centuries. Domesticated, they were first brought to Europe from the region of West Africa known as Guinea, hence the name. From what they tell me, this noisy, polka-dotted character seen wandering around American farmyards today is little different from his country cousin still in the African wilds. He is civilized, that's all, and he likes it. He has taken to eating doled-out cracked corn instead of pilfered Kafir corn—or whatever a guinea hen eats in Africa—and it agrees with him.

Introduced into the West Indies, it was a different story. Maybe the Puerto Ricans, Haitians, Cubans and the like, weren't so free with the cracked corn; or maybe there was something vaguely familiar about the deep forests of these semi-tropical islands—a message from the jungle in the warm night winds drifting down from the dark hills—that awakened an instinct out of the distant past. Whatever it may have been, they didn't hang around the back door waiting for the axe

Photos by Dan Holland



Guinea hen country. From left: Ray P. Holland, Ernesto and Ernesto's dog "Tilda".

"DEVELOP ELKDOM'S RESOURCES"



FEBRUARY can be a power-packed month for every Elk. It is the shortest month of the year, yet it includes the birthdays of George Washington, Abraham Lincoln, and the Benevolent and Protective Order of Elks. In addition to this historic triumvirate, February includes a gay festival of the heart—St. Valentine's Day.

Why then, commemorating our 89th anniversary, should we not stimulate our activities in behalf of the principles of our Order?

Thousands of fine American gentlemen, once members of our Order, were forced to demit because of circumstance. Many are to be admired because in times of economic stress they placed family welfare above all else.

Elkdom believes in family preservation because without family our nation could not become the strong America we expect. But today many of these same thousands would like to re-affiliate. It remains only for us to invite them back to the warm fellowship of Elkdom.

I know of no finer birthday gift to Elkdom than the reinstatement of these splendid Americans.

The present Exalted Rulers have but two more months to contribute to their records. These remaining sixty days present a wonderful opportunity to bring former members back into the fold—a truly heartfelt accomplishment in the Valentine month.

LET'S GIVE ELKDOM A LIVING PRESENT FOR HER 89th BIRTHDAY!

- More reinstatements in every Lodge.*
- Deserved honor to Past Exalted Rulers.*
- Enthusiastic February Clinics.*
- Participating Memberships in the "Heart of Elkdom."*
- New Lodges in every state.*
- Increased leadership in community affairs.*

With these gifts to Elkdom the future progress of our Order and our nation is assured for our Youth.

Very sincerely,

GRAND EXALTED RULER

A Message from the Grand Exalted Ruler

"A STRONGER ELKDOM FOR A BETTER AMERICA"

Leather Lullaby

BY ROBERT TURNER

They could have their title—their headlines—and most of all, Buster McKoy

BY THE third round Danny Shane had enough. He wished he could leave the premises. He wished he could go home where it was peaceful and just sit awhile with Emily and listen to his Fats Waller records or maybe play a little hot piano for her, himself. They could have their fight racket. They could have their welterweight championship and the big money and the sports page headlines. He would give it all to them.

But they wouldn't let him do that. Jingo Jones, his manager, wouldn't let him. He just kept screaming: "The right, Danny! What's the matter with you? What are you waiting for? Hit him with it! Give him that sweet right hand!"

The blood-mad Arena crowd wouldn't let him. They just kept screaming, period. Worst of all, Emily Allen was against him. Her, sitting there in the second row, so blonde, so cute, so all het-up, yowling: "Kill him, Danny! Don't let him do that to you! Go in there and fight him, Danny boy!"

Buster McKoy heard that. He got Danny into a clinch and said: "That's a great girl. She got a sensayuma. Kill me, she says. With what? With kindness?" Buster grinned.

Buster McKoy was a good strong boy and one who enjoyed his work. He grinned all the time. He would have whistled while he worked, except for the mouthpiece clenched between his teeth. Bus was conscientious. He used every trick in the book. He had a genteel way of pushing a thumb into Danny Shane's eye. He had a cement block for a skull and it kept coming up under Danny's chin in the clinches. He had a way with his elbows and a nasty habit of holding-and-hitting and he somehow made it all look very Marquis of Queensbury. Buster was an artisan at his trade.

Just before the end of the third round, Buster caught Danny with a looping left across the chops and staggered him and sent Danny's sweat flying over three rows. Danny didn't like that one. It put the pretty bells to ringing in his ears. He covered and backed off, remembering his Arthur Murray, executing a dizzy little step.

Danny held no malice toward Buster for that one, though. It was the cleanest punch he'd thrown. But Danny had been surprised and offended. He had been insulted. It was like Buster thumbing his nose at Danny. Buster had deliberately

set himself and telegraphed the punch and left himself wide open for a visit from Danny's famed right hand, his Sunday punch. No other fighter in his right mind had ever done that. It was supposed to be suicide. A move like the one Buster had just made had accounted for eighteen other fighters, hitting the paraquet, lining themselves up on Danny's kayo record. Yet Buster McKoy must've seen the pictures of Danny's other fights. He knew about Danny's right. It didn't make sense. . . . Unless Buster also knew the other thing!

Danny didn't get much chance to ponder the matter. A choir of voices was singing in Danny's ears. He leered at the three Buster McKoys coming at him with milling arms and tried to pick the right one. He made a mistake. He got the wrong one. A sweat-soggy glove that closed his left eye and increased the choir a thousandfold, told him that. He reached out blindly and this time he made it and hung on. Buster larruped his kidneys with great zest and worked in a couple of rabbit punches before the ref pushed them apart. Then Buster caught him with a long, hard left to the heart and the bell rang for the end of the third.

The lights made a pretty pinwheel for Danny Shane. He stood with his long, lean legs aspraddle, peering through the pinwheel, looking for Buster. Every once in awhile he pushed out a sluggish left glove, experimentally. The ref turned him toward his corner, said: "End of round. . . . You all right, kid?"

"Fine," Danny told him, moving to his corner with the stiff, awkward dignity of a drunk. "Jus' fine. Havin' a won-erful time. Wish you were here."

"What's the matter, Baby?" Jingo Jones demanded, tears in his voice. "You don't fight. You stand there and let him hit you with everything but the ring posts. I told you. I told you, Baby, you can't box McKoy like you did those last two palookas we take on. Buster likes dancing masters. He eats fancy dans. You got to fight him, mix it. Like before you were champ, Baby, like always before and you take him, you win this one, too."

He couldn't argue. He looked up at Jingo Jones, balking at the ammonia under his nose, wincing at the ice on the nape of his neck and the stab of astringents on his face cuts. He knew why Jingo was all upset. This was a big one for Jingo.

Danny let his mind drift back to the night he'd met the tough little fight manager. It was in the place called "The Blue Flame", a Columbus Avenue jump joint. A strictly cash-and-carry place. They got your cash and then they carried you out. Danny was working as bouncer and doubling on the piano, between brawls. He wasn't much at the keyboard, then. He could run off some rugged Dixie and slap out some Barrelhouse, but that was about all. It was a thing he loved, though, and he hoped some day to be real good at it. Maybe make his living that way.

When Jingo Jones called him over to his table that night, Danny's heart went to the little guy right away. It was one of those things. "Kid," Jingo said. "You play piano real nice. You likewise handle your mitts well. But you could do plenty better with both. I can't teach you no piano but I can show you how to make some dough with those dukes.

Maybe then you could pay to study up how to thump those ivories with a touch more class, too. You got natural talent for both things but they need some professional developing. How would you like to fight for me, Kid? Professionally, I mean. For money?"

And that was the beginning.

He looked up at Jingo, now, working over him here in the corner. "Stop worrying about it, Boss," Danny said. "I'll take this guy. I know what I'm doing. Let me do it my way."

"Your way ain't working so hot, Danny," Jingo said, sadly.

Danny focused his eyes bleakly across the ring at Buster McKoy. He looked at Buster's big, flat head and remembered its boulder-hardness under his chin. He looked at Buster's hard, jutting cheekbones (*Continued on page 39*)

He could tell that this was the moment and threw the right.

ILLUSTRATED BY HERMAN E. BISCHOFF

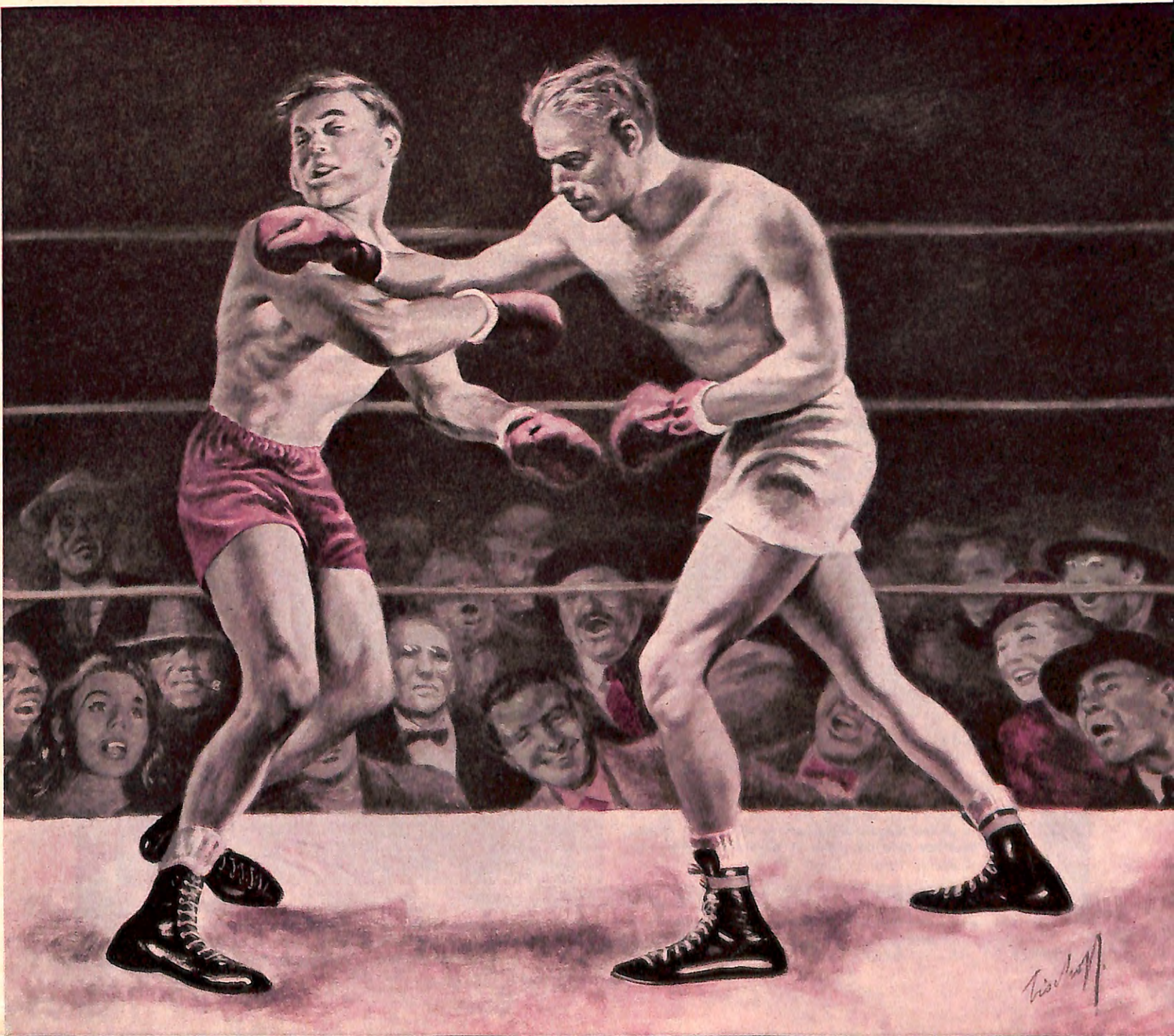

News of the Lodges



Photographed at the banquet marking St. Louis, Missouri, Lodge's 1956 Sports Celebrity Night are members of the Committee in charge, and this year's Outstanding Sports Figure, J. G. Taylor Spink, publisher of the *Sporting News*. Left to right are: Bob Bauman, E.R. Clinton T. Watson, Secy. Lawrence J. Horan, Master of Ceremonies Joe Garagiola, Ray J. Gillespie, Mr. Spink, Charles DeWitt, E. H. Siesel, Chairman Anton Pinter and P.D.D. R. J. Beflach.

St. Louis, Mo., Elks' Sports Celebrity Night a Success

With a capacity crowd of some 500 persons on hand, St. Louis Lodge No. 9 scored a hit with its Annual Sports Celebrity Night Dinner, which proved the most spectacular and successful of the series.

Anton Pinter served as Chairman of the Committee, for the event which saw J. G. Taylor Spink, Publisher of the *Sporting*

News, the international weekly baseball publication, honored as "St. Louis' Outstanding Sports Figure of 1956". With Joe Garagiola, announcer for the St. Louis Cardinals and a former National League catcher, as a witty Master of Ceremonies, some 80 sports celebrities from the area were introduced. Frank Lane, General Manager for the Cardinals, was the principal speaker, while Bob Burns, Sports Editor of the *St. Louis Globe-Democrat*, de-

livered a splendid presentation address.

E.R. Clinton T. Watson presented a plaque and a perpetual motion clock to Mr. Spink, and announced that his name would be inscribed on the Elks' Perpetual Trophy along with those of the previous winners—Stan Musial, Enos Slaughter, Al (Red) Schoendienst, Ed Furgol and Marty Marion. All five were on hand to take part in the ceremony which was broadcast over radio station KMOX and telecast by KSD-TV.

So gratified was the publisher by this three-hour program which paid him tribute that he devoted two full pages of the *News* to the affair, sending an individual copy to each of the members of St. Louis Elksdom.

Virginia Elksdom Mourns Morris L. Masinter

Morris L. Masinter, well known Roanoke, Virginia, Elk, passed away on November 16th at the age of 63.

A Past Exalted Ruler of Roanoke Lodge No. 197, and a former District Deputy, he had been President of the Virginia Elks Association and was considered the founder of the fine Virginia Elks Boys Camp. He was the first President of the Camp Corporation and was its Honorary President at the time of his death. Mr. Masinter also served two terms as a member of the Grand Lodge Committee on Judiciary from 1934 to 1936.

He is survived by his wife and two sons, to whom we offer our warm sympathy.

Cambridge, Md., Elks Open Their New Home

The handsome new home of Cambridge Lodge No. 1272 was opened formally at appropriate ceremonies attended by about



Large picture: Special guests and officers of Wakefield, Mass., Lodge posed for a photograph before the spacious, modern lodge home dedicated recently. Pictured at right on that occasion were, left to right, E.R. Joseph M. Curley, Dr. Edward M. Halligan, the lodge's senior P.E.R., Past Grand Exalted Ruler James R. Nicholson, principal speaker and one of the lodge's organizers in 1912, and William Kelso who has held the office of Secretary for 44 years.

ADDRESS OF GRAND EXALTED RULER FRED L. BOHN: Rooms 121-122, Zane Hotel, Zanesville, Ohio
ADDRESS OF GRAND SECRETARY LEE A. DONALDSON: Elks National Memorial Building, 2750 Lake View Ave., Chicago 14, Ill.

A RED-LETTER DAY FOR IDAHO'S ELKS



Above: The Idaho lodges' cooperation in this outstanding project is evidenced by this photograph, showing E.R. Robert Jahn, right, and W. A. Rossiter, left, with a \$15,000 check given by the members of Idaho Falls Lodge for the construction of the Center, and a \$3,048 check, one of the gifts made regularly by this lodge toward its maintenance.

DECEMBER 1ST was a memorable day for the Elks of Idaho, when work started officially on the construction of the new Idaho Elks Rehabilitation Center in Boise, which will replace the Collister Home and Army barracks which have served as the Elks Convalescent Home since 1947.

Williams S. Hawkins, Chairman of the Grand Lodge Judiciary Committee and a Coeur d'Alene Elk, delivered the dedicatory address at the ground-breaking ceremony at which State Association President Loris Winn presided. The first shovel of earth was turned by Governor Robert E. Smylie, a member of Boise Lodge, ably assisted by little Debby Dains, one of the Center's patients and the 1954 March of Dimes Poster Boy in whose name the Fund-Raising Campaign for the \$388,000 building is being carried on. Mayor Russell Edlefsen, immediate Past Exalted Ruler of Boise Lodge, was also on hand.

Right: among the well known Idaho citizens who participated in the ground-breaking for the Idaho Elks Rehabilitation Center in Boise were, left to right, Chairman Wm. S. Hawkins of the Grand Lodge Judiciary Committee, State President Loris Winn and Governor Robert E. Smylie, a member of Boise Lodge. The young man in the foreground is Debby Dains, a patient at the Center and the 1954 March of Dimes Poster Boy. The Governor officially broke ground for the building, with Debby assisting.



Finances for the new Center are being raised by Idaho's 21,000 Elks, each contributing \$10.00 to this effort, with half the expense of its construction and equipment to be taken care of by the Federal Government under the Hill-Burton Act. Its operating budget will be met by selling rehabilitation services to volunteers health organizations, such as the United Cerebral Palsy Assn., the National Foundation for Infantile Paralysis, the Multiple Sclerosis Society, the Arthritis and Rheumatism Foundation, and the like. Many handicapped patients will be unable to pay their own way, and when there are no funds available the Idaho Elks will pay the entire fee, through the annual contribution of \$2.00 by each Elk in the State.

Superintendent Clayton Lorenzen reports that the Center will have facilities for 37 in-patients, and 125 out-patients, in addition to a day-patient program for 15 handicapped persons. While the

prime function of the Center will be the rehabilitation of children, adults will be admitted when space permits. Under the direction of trained personnel special education classes will be available, and children admitted there will be able to carry on their school work; a special education program for cerebral-palsied youngsters will be an important part of the project.

The new facility will have large speech, physical and occupational therapy departments with individual treatment rooms, a combination gymnasium and auditorium, a 10,000-gallon pool for both therapy and recreation, and a model apartment consisting of a kitchen, living room, dining room and bath for training the handicapped in activities of daily living.

Other available services include psychological testing, social services, counselling and guidance, with a complete pre-vocational and vocational area for the rehabilitation of adults.

300 members and their guests from many lodges in Virginia and Maryland.

The Grand Exalted Ruler was represented by Past Grand Exalted Ruler Robert South Barrett who gave an address outlining the Order's objectives and congratulating his hosts on their achievement. Pres. Claude S. Martin of the Maryland, Delaware and District of Columbia Elks Assn. was the dedicatory speaker on the program at which D.D. Lloyd B. Pahlman presided.

The new home, located on a 140-acre tract fronting an arm of Chesapeake Bay, will provide ample room for all outdoor activities, including duck hunting.

Iowa Elks Hold Midwinter Session at Iowa City

Pres. Robert E. Davis presided at the annual Midwinter Meeting of the Iowa Elks Assn. at Iowa City when nearly 300 delegates were welcomed by Mayor Leroy Mercer, a member of the host lodge.

Guests of honor were Grand Exalted Ruler Fred L. Bohn, who delivered an inspiring talk, and Past Grand Exalted Ruler Henry C. Warner.

Reports of Committee Chairmen, District Deputies and State Vice-Presidents revealed fine progress for the State, with an over-all membership gain of five and

one-half per cent. Under the Chairmanship of William Ward, the Veterans Service Committee will continue to provide entertainment for the VA Hospitals, and to purchase such items as duplicating machines, television sets and patient-lifting devices for these institutions.

Chairman J. T. McKeever and his Youth Activities Committee is continuing the annual two-week camping trip for boys at Camp Whitcomb, near Milwaukee, and will again sponsor Youth Leadership Contests throughout the State.

The Lloyd Maxwell Ritualistic Trophy was captured by Decorah Lodge, with Boone second and Muscatine third.

LODGE NOTES

Several weeks ago, the Elks of Crisfield, Md., Lodge were saddened to learn of the death of Harold L. Loreman, their first E.R. and a Charter Member. Only ten days earlier, a delegation of members led by E.R. Roger Evans and P.E.R. Fred Gerald had visited Mr. Loreman at Peninsula Hospital. The occasion was Mr. Loreman's 77th birthday, and his visitors presented a 50-year-membership pin to him at that time.

Members of the local high school football squad were guests of Leominster, Mass., Lodge on the eve of their traditional Thanksgiving Day contest with Fitchburg High School. Joe Zabalski, head coach at Northeastern University, was guest speaker, and Rev. M. A. Genovese was a special guest. Charles Broderick, completing his 26th year as coach at Leominster, saw his boys take the game the following day and close the season with a 7-2 record.

Nearly 100 hunters have given their deer and elk hides to Farmington, N. M., Lodge to be put to use in veterans' rehabilitation work. After drying on the roof of the lodge home, the skins were sent to California for processing, most of them returning to VA Hospitals in New Mexico for occupational therapy departments.

The closed wards at the VA Hospital at Jamaica Plain are being visited regularly by the Elks of Quincy, Mass., who have inaugurated a monthly variety show there under the direction of Jimmy Kelly whose band plays at the lodge's weekly dances. Hospital Committee Chairman Thomas Garrity reports that in addition to the monthly closed ward show, a professional variety show is being performed at the hospital auditorium every month with P.E.R. and lodge Secy. E. A. Densmore as Master of Ceremonies.

Orange, N. J., Lodge helped the community celebrate its sesquicentennial in many events. On Oct. 13th, the Old Time Athletes attended a football game, and later a Dutch treat party at the lodge home. On the 24th, photos of all P.E.R.'s of the lodge since 1889 were unveiled and on the 27th, about 80 members, including ten P.E.R.'s marched in the colorful parade behind a car carrying P.E.R. Charles Werner, now nearly 93 years old, and ahead of a float carrying a group of crippled children representing the Elks' favorite charitable endeavor.



A class of 54 outstanding citizens was initiated into Montclair, N. J., Lodge not long ago with the 1955 State Championship Ritualistic Team from Lyndhurst Lodge officiating. Seated with the officers of the host lodge are Past Grand Exalted Ruler William J. Jernick, center, with the lodge's oldest living P.E.R., James J. McMahon, on his left, and E.R. Sidney McConnell on his right. Others include Joseph F. Bader of the Grand Lodge Committee on Lodge Activities, P.D.D. John J. Graziano and P.E.R.'s C. E. Crawley, Louis A. Amato, J. P. Mulligan and Rocco Caponigro, Jr.



Photographed when Waycross, Ga., Lodge welcomed 19 candidates as a tribute to State Pres. C. J. Williams are the candidates, lodge officers and special guests. Seated, left to right, are Executive Director Lee O. Dry of "Aidmore", the Ga. Elks Home for Crippled Children, D.D. M. A. Froberg, Pres. Williams, E.R. G. M. Thompson, Est. Lect. Knight C. N. Mayo, Secy. J. W. Bellinger, Loyal Knight J. W. Leshner and Lead. Knight J. L. Wolfe. Officers standing are Organist J. W. Snellgrove, Inner Guard Walter T. Kearson, Chaplain Randolph A. Tyre and Esq. W. A. Tuten.



This crowd of 456 members attended Tacoma, Wash., Lodge's annual Old Timers Night when all Elks of over 25 years' affiliation are honored. Tacoma lodge has 772 such members, including 36-year-member E. O. Johnson, Secy.-Mgr. for the lodge for 22 years, 57-year-member Frank M. Lamborn and 55-year-member Chas. H. Herald. William Knabel, initiated in 1916, was Chairman for the event which included a buffet dinner and entertainment.

San Luis Obispo, Calif., Elk Dr. Kirtland Dies

Dr. Howard B. Kirtland, a Past Exalted Ruler of San Luis Obispo Lodge No. 322, passed away suddenly on October 25th following an emergency operation in a San Francisco hospital.

Born in Pueblo, Colorado, 67 years ago, Dr. Kirtland took up residence in San Luis Obispo in 1914 and had been one of its most prominent and distinguished civic leaders ever since.

A devoted Elk, Dr. Kirtland was a for-

mer President of the California Elks Assn. On his death, his family requested that in lieu of flowers, donations be made in his name to the cerebral palsy fund which is the California Elks' Major Project. He is survived by his wife, two sons, a daughter and a sister.

The San Luis Obispo dentist had been President of the Santa Lucia Council of the Boy Scouts for 12 years. He was also a member of the Rotary Club, and the Masons, and had served as President of the Chamber of Commerce and the American Red Cross Chapter.

**Waycross, Ga., Elks
Honor State President**

Not long ago, Waycross Lodge No. 369 initiated a class of 19 candidates as a tribute to C. J. Williams, Pres. of the Georgia Elks Assn. Mr. Williams was on hand and delivered an inspiring address. Other guests included D.D. M. A. Frohberg, who made this the occasion for his official visit, and Lee O. Dry, Executive Director of "Aidmore", the Georgia Elks Hospital for Crippled Children.

Waycross Lodge is enjoying a very successful year, and expects to exceed the

ten per cent increase in membership which has been requested by Grand Exalted Ruler Fred L. Bohn.

**Richmond, Ky., Elks
Honor Their Scouts**

For the past 18 years, Richmond Lodge has been sponsoring Boy Scout Troop No. 67. Not long ago, the Elks honored these boys at a special program in the lodge and club rooms. The occasion took recognition of the Troops' outstanding showing at the Camporee held near Berea, Ky.

The boys opened the program with the Scout Oath and the Scout Law, and then

led the Pledge of Allegiance to the Flag. P.E.R. Harry Moberly, Chairman of No. 67's Boy Scout Committee, presented to the Troop a canoe paddle, the prize given for the Troop which had the best patrol at the Camporee. The award became the permanent possession of the Richmond youngsters, since they had achieved this honor for three consecutive years.

The Troop presented a gift to Elk Raymond Norris, retiring Scoutmaster who has done a splendid job with this group for a number of years. Mr. Norris also received a tribute from the lodge.

(Lodge News continued on page 21)



When Longmont, Colo., Elksdom celebrated its 50th Anniversary, these six surviving Charter Members were on hand to receive special tribute. They are, left to right, P.E.R.'s V. F. Allen and Charles Gunning, Dr. W. J. White, Ross Powell, Treas. Sam Gildner and Holt McKeirnan.



Galena, Ill., Lodge proudly presents the Muehleip family, all members of the Order. Left to right: Paul, P.E.R. and Trustee Delbert, Esquire Norman, Darrell and LaVerne Muehleip, all former servicemen, and their father, 25-year-Elk William Muehleip, a veteran of World War I.



Photographed when Bronx, N. Y., Lodge presented Life Memberships to 54 of its veteran affiliates were, left to right, Rt. Rev. Msgr. Edward Nilan, County Judge William Lyman, Lt.-Gov. George B. DeLuca of New York State, a P.E.R., Bronx County Public Administrator P.E.R. John T. Meehan, Toastmaster, and E.R. Gene Amabile. Judge Lyman and Mr. DeLuca, both 30-year Elks, were two of the recipients of the tribute.



Meeting to discuss the Michigan Elks Assn.'s newly adopted Major Project to assist handicapped children were, left to right, seated, State Trustee Carl H. Fernstrum, Vice-Pres.-At-Large Nelson H. VanDongen, Chairman Hugh L. Hartley, Secy. Dr. M. J. Kennebeck and P.D.D. Philip Barney; standing: State Pres. Robert A. Burns and E.R. Ken G. Pavey of Iron Mountain Lodge where this meeting took place.



Elk officials on hand for the homecoming of D.D. George H. Mackie to Leominster, Mass., Lodge included, left to right foreground, Grand Treas. Edward A. Spry, D.D. Mackie and Past Grand Exalted Ruler E. Mark Sullivan. Standing: former Chairman of the Grand Lodge State Assns. Committee James A. Bresnahan, William F. Hogan of the Grand Lodge Ritualistic Committee and State Pres. John J. Murray who led 22 State officers. A class of candidates was initiated, prior to a banquet.



D.D. Howard M. Cavender, right, who with his father, the late Howard M. Cavender, Sr., killed in action in the Philippines during World War II, were Manila, P. I., Lodge's first Father-Son P.E.R. team, is pictured with the lodge's sole surviving resident Charter Member, Carson Taylor, third from left, and E.R. Edward A. Bellis and P.E.R. Amos G. Bellis, left and second from left, respectively, who are the lodge's only other Father-Son Past Exalted Ruler combination.

ELKS LODGE ACCOMMODATIONS

WE HAVE HAD so many requests for an Elks Lodge accommodation list that we plan to publish portions of the list from time to time in our travel columns. This ninth installment will be followed, as space permits, in later issues by additional listings.

ILLINOIS (Continued from December)

STERLING. Dinner (Sat. only); Cocktail Lounge
STREATOR. Dinner (Except Sun.); Cocktail Lounge
SYCAMORE. Cocktail Lounge
TAYLORVILLE. Dinner; Cocktail Lounge
URBANA. Cocktail Lounge
WATSEKA. Cocktail Lounge
WAUKEGAN. Lunch; Cocktail Lounge
WEST FRANKFORT. Cocktail Lounge
WOODSTOCK. Dinner; Cocktail Lounge

INDIANA

ALEXANDRIA. Bar
ANDERSON. Lunch & Dinner; Cocktail Lounge
BEDFORD. Lunch & Dinner; Cocktail Lounge
BICKNELL. Cocktail Lounge
BLOOMINGTON. Lunch & Dinner; Cocktail Lounge
BLUFFTON. Cocktail Lounge
BOONVILLE. Lunch & Dinner; Bar
BRAZIL. Lunch & Dinner; Cocktail Lounge
COLUMBIA CITY. Cocktail Lounge
COLUMBUS. Lunch & Dinner; Cocktail Lounge
CONNERSVILLE. Lunch & Dinner; Cocktail Lounge
CRAWFORDSVILLE. Lunch & Dinner; Cocktail Lounge
DECATUR. Cocktail Lounge
DUNKIRK. Bar
EAST CHICAGO. Rooms (Elks, Wives & Guests); Breakfast-Lunch-Dinner; Cocktail Lounge
ELKHART. Lunch & Dinner; Cocktail Lounge
ELWOOD. Bar
EVANSVILLE. Lunch & Dinner; Cocktail Lounge
FORT WAYNE. Lunch & Dinner; Bar
FRANKFORT. Lunch & Dinner; Cafeteria; Cocktail Lounge
FRANKLIN. Bar
GARRETT. Bar
GARY. Lunch & Dinner; Cocktail Lounge
GOSHEN. Cocktail Lounge
GREENCASTLE. Cocktail Lounge
GREENFIELD. Lunch; Cafeteria; Bar
GREENSBURG. Lunch & Dinner; Cocktail Lounge
HAMMOND. Bar
HARTFORD CITY. Lunch & Dinner; Cocktail Lounge
HUNTINGTON. Bar
INDIANAPOLIS. Lunch & Dinner; Cocktail Lounge
JEFFERSONVILLE. Cocktail Lounge
KENDALLVILLE. Cocktail Lounge
KOKOMO. Lunch & Dinner; Bar
LA PORTE. Lunch; Cocktail Lounge
LAFAYETTE. Lunch & Dinner; Cocktail Lounge
LAWRENCEBURG. Cocktail Lounge
LEBANON. Lunch & Dinner; Cocktail Lounge
LIGONIER. Cocktail Lounge
LINTON. Dinner; Cocktail Lounge
LOGANSPOUT. Lunch & Dinner; Cocktail Lounge
MADISON. Lunch & Dinner; Cocktail Lounge

(Indiana to be continued)

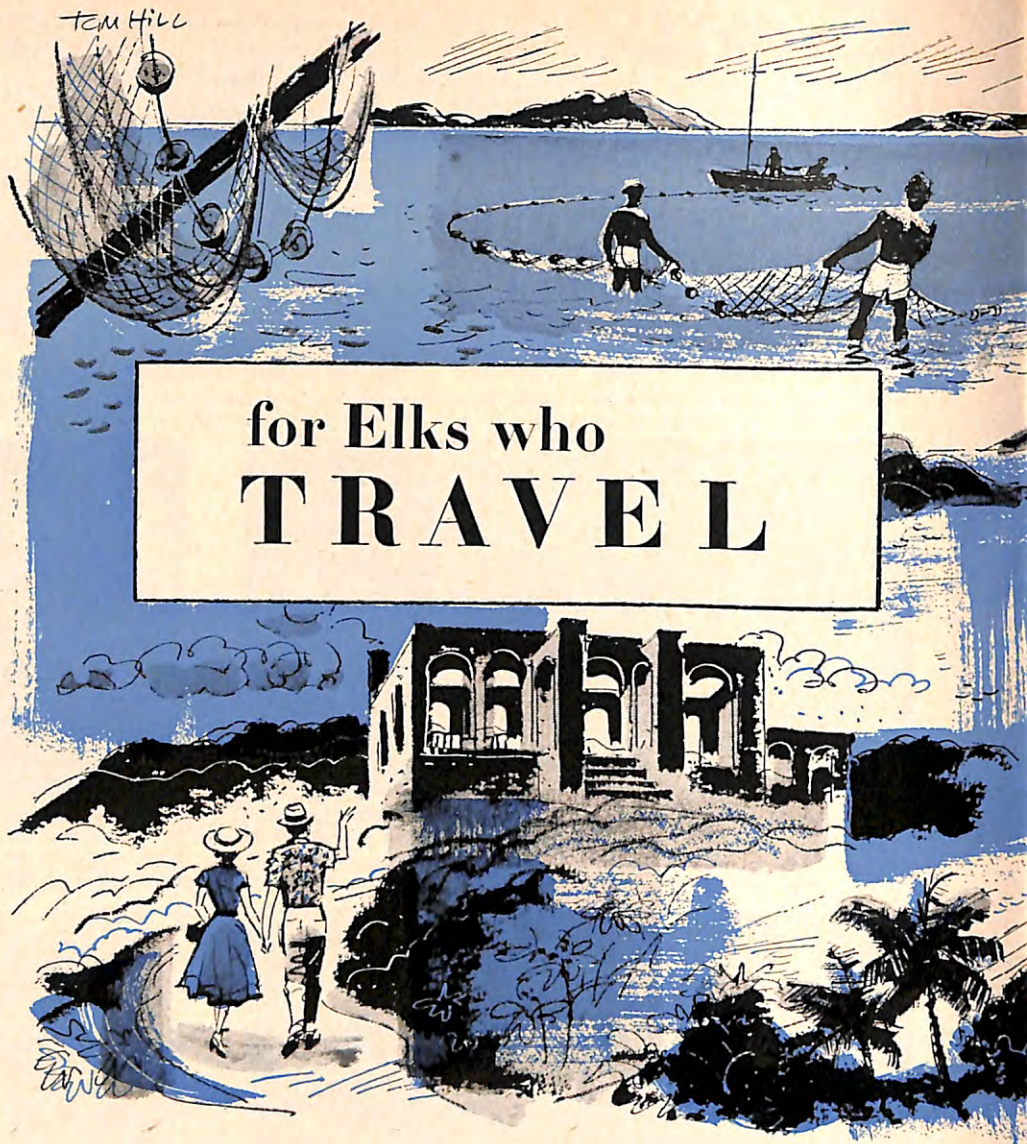

for Elks who
TRAVEL

**Our Caribbean islands offer a restful spot
for a vacation with a touch of early history.**

BY HORACE SUTTON

THE ACTUAL ESTABLISHMENT on the first of December, 1956, of the Virgin Islands National Park, a Federal preserve with the same standing as Yellowstone or Glacier, should serve notice on the public that our Caribbean Islands are not merely for the rich, the languorous, or the divorcing. (There was a time when St. Thomas was a thriving divorce mill where matrons could establish residence and work up a suntan at the same time). True, the Virgin Islands National Park is limited to about two-thirds of the island of St. John, the most remote and unspoiled of the three islands that we bought from the Danes in 1917 for \$25,000,000. What visitors will be able to do in this National Park is lie supine on virtually any one of the dozens of sugar-white beaches that decorate the island like fringe on a Victorian bedspread. He will be able to fish offshore for barracuda or sail or tarpon, to mention merely a few varieties of the

game fish in waters surrounding the new park. He will be able to revel in the foliage of a tropical botanical park growing *au naturel*—mango trees, flamboyants bursting into brilliant orange, turpentine trees, silk cotton trees, bougainvillea growing as easy as crab grass in a suburban garden.

In time the historical sights of St. John will be as well marked as they now are in Federal preserves across the country. And there will be much to mark. For instance, in the days of the Danes, sugar plantations dotted the island. The slaves did the work with the Danes overseeing. The foreman blew a sort of reveille on a conch shell and the transplanted workers from Africa would filter into the fields before daylight had arrived. By nine they would be allowed to fix their own breakfast in the fields. Besides working for the owners at no pay, they were required to raise their own crops for food, and when a crop

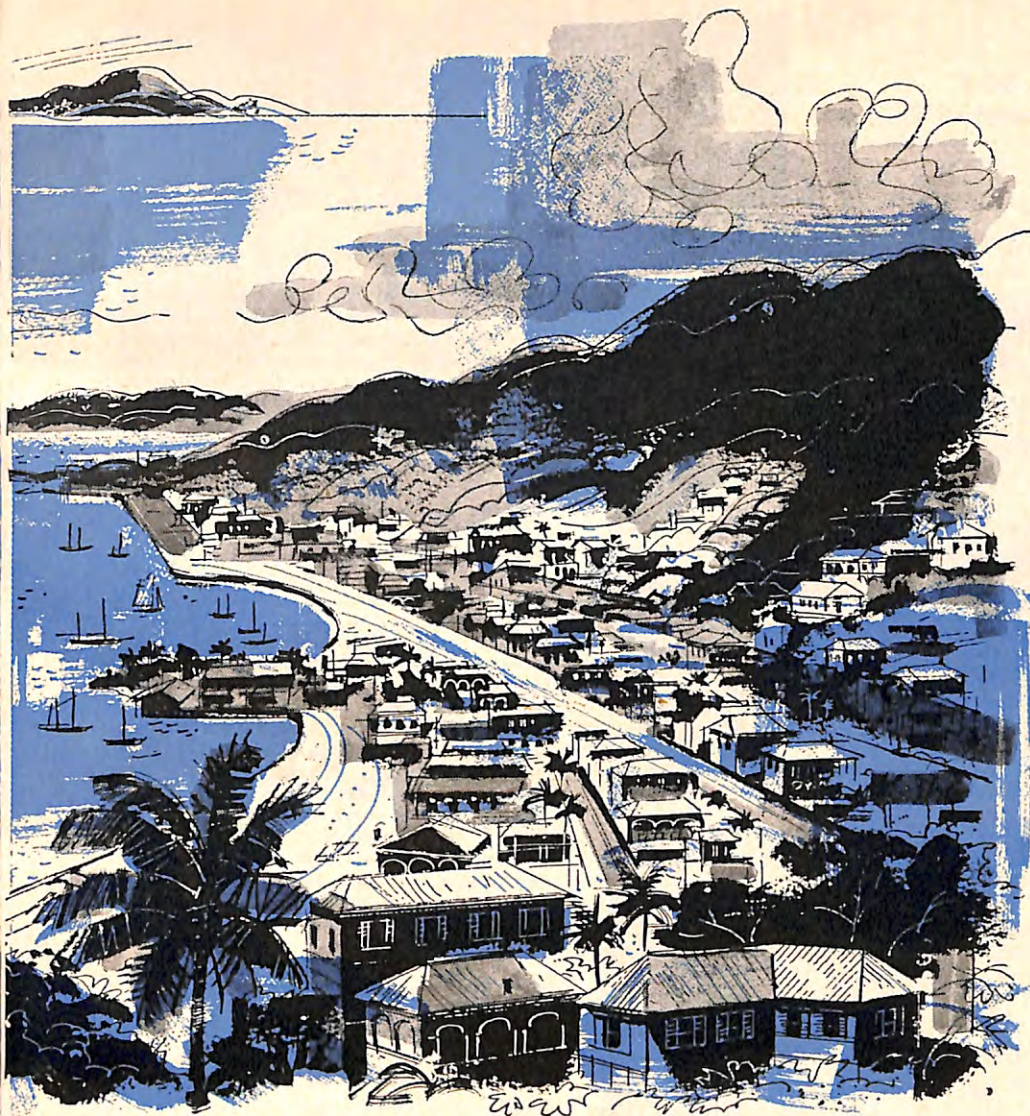

ILLUSTRATED BY TOM HILL

failed and the plantation owners refused to spend money importing food from St. Thomas, the slaves revolted. That marked the beginning of the end of the Danish sugar plantations in the Caribbean and most of the big estates have been all but overgrown since then. National Park visitors will find them now in a tangle of vines at the bottom of a valley, along a sandy beach, and near one of the resorts itself.

There are relics, too, of earlier days—stone carvings of the ancient days of the Indians, Arawaks to be specific, who were later vanquished by the more warlike Caribs. Besides wrestling Arawaks, the Caribs were also fond of going to the mat, albeit a watery one, with local sharks which they attacked with wooden knives. The scene of much later history on the tiny island of St. John can be observed from Picture Point, an elevation in the Bordeaux Mountains which looks down on three hurricane holes where Sir Francis Drake stashed his ships against the fury of the storms of that day.

In addition to the history there is plenty of place to enjoy the good life. For one thing, the Rockefellers, who bought the tract of St. John which they

turned back to the government as a National Park, have also spent millions rehabilitating Caneel Bay Plantation, which originally was a retreat for employees of the Danish West Indies Company. It now has room for nearly a hundred peace-seeking citizens who live in seaside cottages a step from the water. The rates run in the mid-twenties per person per day with meals included, of course.

The dining room is an open patio; from time to time there is music dished up by local calypso talent; but mostly there is little to do at night save rest up from the strenuousness of the day's activity. This could include swimming from any one of the ten beaches, or sailing or power boating hither and yon to neighboring islands, both U.S. or British. Not quite as big as Caneel Bay, and not quite as expensive either is Trunk Bay, a simple establishment on a seaside hillock overlooking one of the best beaches in the Caribbean. Figure about \$150 for two per week, which includes meals usually featuring a strong local accent—kingfish, hearts of palm, coconut shreds, and that sort of thing. Housekeeping cottages are also available at Gallows Point, a promontory operated

(Continued on page 32)



**LOW-COST
RETIREMENT
in FLORIDA
MARTIN COUNTY
is for reg'lar folks!**

Midway along Florida's Atlantic coastline is healthful Martin County. Where living costs are low and the best things of life are free. And where you'll meet reg'lar folks and do the things you've always wanted to do. That's the magic of Martin County...where nobody puts on "airs" and life is unhurried, casual and relaxing. It's where a Florida sun and ever-cooling ocean breezes replace the strain of winter storms and furnace-tending. Where goin'-fishin' is just a way of life. Small towns and cheerful hamlets and clusters of modest-income retirees...as well as quietly secluded estates. Rich inland ranch and farmlands...and opportunities for many small producers of winter vegetables, citrus and cut flowers.

FREE BOOKLET Or, better yet, plan to visit us this winter or next summer.



**Martin County
Advertising Commission
Box 686-C Stuart, Florida**

Name.....
Address.....
City.....State.....

FOR Particular ELKS

**ABERDEEN LODGE
IS THEIR CHOICE**

Here are 32 comfortable rooms, 17 with baths including 3 suites and the rates are only what you'd pay in any public hotel where you *wouldn't* get full club accommodations. Rooms \$2.50 to \$3.50, monthly \$25 to \$45. Limited to Elks only.

Lunch from 11:30 to 1:30. Recreation rooms for cards and billiards. Fine cocktail lounge.

ABERDEEN B. P. O. ELKS No. 593
Broadway and Wishkah Aberdeen, Wash.

**24 well-equipped rooms,
many with baths.**

Good food in our handsome Rainbow Lounge prepared by our own chef noted for excellent cuisine.

SCRANTON, Pa., No. 123

A few accommodations available.
Advance notice appreciated.

**You'll Enjoy Your Stay
in
WILLIAMSPORT, PA.**

Williamsport, Pa., Lodge No. 173 welcomes traveling Elks. Our hotel facilities are stag only with clean, livable rooms—20 of them with connecting showers for transient guests. Rates—\$2.50 and \$3.00. Well equipped grill with an excellent cuisine. Dining room for public use.

Yes, you'll enjoy your stay in Williamsport if you stay at the Elks.

AN "OPERATION EUROPE" REPORT FOR THE

Elks National Service Commission

6-9-56
Longeville Les St Avold
Metz, France

Dear Mr Williams,
Hello there, how are you? I hope you
+ your wife are fine as is the rest of our
gang here. At the present I have a slight cold.

40 km. east of
here is Longeville
enjoyed your show
all here can
want to thank
for sending you
I hope the
has very slow
know. But act
got these prints
you will like it

Well so long until we meet again
I would like to hear from you if you have
anything to drop me a line

So long
Sincerely
Warren Spencer
50 Rue de Metz
Longeville Les St Avold
Metz, France



A reproduction of the letter Manny Williams received from Warren Spencer, an American serviceman in France, a few weeks after Manny, left foreground, and his wife, center foreground, returned to the States after their entertainment tour of our European bases. The letter accompanied this snapshot, one of several taken by the young soldier of the entertainer and his wife, and some of the boys they visited.

Dear Mr. Williams,

Hello there, how are you? I hope you and your wife are fine as is the rest of our gang here. At the present I have a slight cold.

I hope you remember us? We're located 40 km. east of Metz. The name of the town here is Longeville Les St. Avold. We all enjoyed your show very much and I hope we all here can meet and see you again. We want to thank you and the U. S. Elks for sending you to us.

I hope this letter reaches you O.K. I have been very slow in sending these to you, I know. But actually, believe it or not, I just got these prints a couple of weeks ago. I hope you will like it as the rest never came out. Well, so long until we meet again.

I would like to hear from you if you have any time to drop me a line. So long.

Sincerely,
Warren Spencer

ON THIS page in your September issue, you read a story on Manny Williams, the comic-magician who worked "The Hardship Circuit" in France and Germany on an entertainment tour of our bases there, financed by your Service Commission. Manny has just turned over to the Commission a highly interesting account of his travels in which he reveals that, after clearance, inoculations and passports were taken care of, he and his wife left from McGuire Air Force Base on a four-motor plane bound for Europe.

When they arrived in Rhine Main, Germany, a U. S. Air Force Base, they were met by Sergeant Tomalko, who was the Williams' guide, driver and interpreter for the entire tour. That evening was spent in Wiesbaden, and in the morning they met Captain John Doherty and Lieutenant Fred P. Schmidt who briefed the Williams on their carefully planned itinerary.

"Our first show was at a hospital in Wiesbaden," Manny reports, "and here was brought home to me vividly the wonderful work the Elks are doing. Here were boys, sick and injured, watching me, and as the show went on, their expressions changed from sadness or resignation to smiles and laughter." Audience participation is part of his act, and he took many volunteers from the audience to the stage, to the delight of both officers and men.

There followed a succession of one-night and afternoon stands at villages and hamlets, some so remote that they were

unknown to neighboring communities, Manny's report reveals, and wherever there was a serviceman stationed where no diversion was available, he brought them Elk-sponsored magic-comedy.

This went on day after day, between France and Germany, and the enthusiastic reception accorded the travelers was more than heart-warming.

"It was interesting to see how American boys have made friends with the native element everywhere," Manny comments. "One part of our job was to cement good relations between our men and the inhabitants, and in furthering that noble purpose we always invited local residents, wherever possible, to see the performance."

WILLIAMS cites as an example the incident at one of his stops located near a German orphanage housing about 50 boys. The youngsters accepted the invitation to see the show, and after cleaning out the mess hall to make room for them, and setting up chairs and benches, Manny put on a special children's show. The young guests were astounded, he reports, since they'd never seen any entertainment of any sort, let alone an American magician, and our boys got a tremendous thrill watching the children's reaction.

"Our boys have already established such amicable relations with the natives that our efforts were merely accumulative," Williams states. "With few exceptions we were greeted enthusiastically, and the ca-

maradarie between servicemen, the towns' inhabitants and ourselves formed a triangle of friendliness."

Manny reports many interesting incidents, one in particular which occurred at one of his stops on the Russian-German border, where sentries and guards practically face each other. "This particular American guard was amazed one morning to see Russian tanks, with guns pointed westward and planes overhead, coming toward the American lines. He immediately alerted the American contingent of five men, each of whom had orders as to how to proceed in this type of situation; they took the prescribed steps and it was not long after the incident occurred before all Europe was alerted.

"It turned out that this was only another cold-war maneuver, for the Russians went directly to the edge of their line, stopped and turned about."

FOLLOWING each performance, Mrs. Williams made an effort to learn from our men their names and home addresses. When they returned to the United States, they telephoned the families and friends of as many of these men as they could. The gratitude expressed by these families on hearing such first-hand news of their boys overseas was one of the greatest thrills experienced by the comedian and his wife when they returned after their month-long journey under Elkdom's pledge of remembrance.

NEWS of the LODGES



Left: When D.D. Carl C. Merrill visited Henderson, Nev., Lodge he was photographed with Elk officials and the lodge's newly-formed "Teen-age Visiting Committee", a group of daughters of five Elks who will visit other lodge members' children who are ill. Left to right are Pat Vanhorne, E.R. Darrell Pitts, Billie Cureton, Joe Lappin, D.D. Merrill, Secy. Lloyd G. Fields, Carol Derrick, Chairman George Vanhorne, Judy Simpson and P.E.R. Don J. Detomasi.



Above: During the Eastern New Mexico State Fair, held in Roswell, the local Elks entered this beautiful float, featuring the State Association's Major Project, aiding cerebral-palsied children.

Below: Competing with 30 able teams, Portland, Ore., officials took the State Ritualistic Contest at Bend. Left to right, foreground, are Chaplain H. N. Holm, E.R. A. P. Vengelen, and Esq. L. A. Benson; standing: Inner Guard E. I. Hoffman, Est. Loyal Knight Edward Kuchler, Lect. Knight Ben Harlow, Asst. Chaplain C. N. Freeman and Lead. Knight E. W. Neubert.



Right: These Farmington, N. M., Elks chartered a 37-passenger bus and paid a surprise visit to the members of Durango, Colo., Lodge. The visitors' Organist, Angelo Turano, brought his accordion along to entertain on the trip. On their arrival, E.R. Roy McColum and P.E.R. Jim Carpenter, State Vice-President for the New Mexico North Dist., were escorted to seats of honor at the Durango meeting and both spoke briefly.



Left: When D.D. George E. Hutchinson paid his official visit to Paramount, Calif., Lodge, a class of 69 was initiated in honor of Grand Exalted Ruler Bohn. Later, 11 additional candidates were brought into the lodge in a similar tribute to the Order's leader. With the lodge officers and all its P.E.R.'s are, seated third and fourth from left foreground, E.R. Jesse L. Grisham and D.D. Hutchinson.

Right: These Major League Baseball stars participated in Modesto, Calif., Lodge's 9th Annual Charity Major-Minor Baseball Game this year, netting about \$4,000. They include Jim Small, Curtis Flood, Rocky Bridges, Jim Davis, Mike Bates, Larry Jackson, Roy Smalley; Joe DeMaestri, Pete Daley, Hank Sauer, Duane Pilette, Bob Bowman, Bill Posedel; Troy Herriage; Eddie FitzGerald, Wayne Belardi, Billy Martin, Frank Robinson, Jack Shepard, Tony Robello, Charlie Wallgren, Marv Grissom; Gene Mauch.



Celebrating the completion of six-year-old Albion, Mich., Lodge's new home, left to right, Mrs. M. D. McKay, host E.R. McKay, State Pres. Robert A. Burns and Mrs. L. L. Hamilton, wife of State Assn. Secretary Hamilton.



dinner followed by a show for the children and Old Timers Night when all members of 35 or more years' affiliation were guests at a special banquet. On this occasion, No. 1055's six surviving Charter Members, all formerly affiliated with Boulder Lodge until Longmont's institution in 1906, were on hand.

The gracious \$100,000 home of Longmont Lodge came of age this year, having been dedicated in 1925 by that year's Grand Exalted Ruler, William Hawley Atwell. Its spacious rooms were the scene of many of the Jubilee's activities, although several of the largely attended events were held in St. Vrain Memorial Building, toward the construction of which Longmont's Elks donated \$30,000, one of the many important civic contributions it has made over the years.

St. Paul, Minn., Elks Make Civic Gift

A beautiful 9' x 12' nylon American Flag was presented to the city by the members of the St. Paul Lodge No. 59. The gift was made as the result of a suggestion offered by Mayor Joseph E. Dillon that it would be an appropriate gesture for a civic or patriotic organization to supply the city with suitable flags for the official staff.

E.R. Laurence E. O'Connor, Jr., dedicated the banner at fitting ceremonies, when members of the lodge and its official color guard raised it for the first time.

Arrangements for the gift were handled by Social and Community Welfare Committee Chairman Harold Sorenson and D.D. Victor F. Angerhofer.

Loyalty Is Uppermost to Goldfield, Nev., Elks

We are indebted to Grand Exalted Ruler Fred L. Bohn for letting us see the report he received from Carl C. Merrill, his Deputy for the State of Nevada, concerning Goldfield Lodge No. 1072. It was so interesting to us that we feel the story should be passed along to the entire membership of the Order.

Goldfield was once a prosperous mining community and well known in the West,



Las Vegas Lodge's Nevada State Bowling Champions, left to right: Dave Mengarelli, Art Johnson, Lee Shugart, Robert Rogers and Earl Hartke, Sr.

NEWS of the LODGES

Montclair, N. J., Elksdom Growing

Several months ago, Montclair Lodge No. 891 welcomed a class of 54 outstanding citizens who pledged their devotion to the Order's principles under the direction of the Lyndhurst Elks' State Championship Ritualistic Team. Many leading Elks of the State were on hand for this memorable occasion, among them Past Grand Exalted Ruler William J. Jernick whose encouragement is largely responsible for the rejuvenation of Montclair Lodge. Others included Joseph F. Bader of the Grand Lodge Committee on Lodge Activities and P.D.D. John Graziano, all of whom were welcomed cordially by E.R. Sidney McConnell, his officers and many of the lodge's Past Exalted Rulers.

So inspiring was this program to the members of No. 891, that they began immediately on their plans to initiate a class of 50 as soon as possible, a goal which was realized last month.

Golden Jubilee Celebrated by Longmont, Colo., Elks

Fifty years of progress was marked by the membership of Longmont Lodge No. 1055 during the last month of 1956. A week-long observance of its half-century existence began on the tenth with Open House and closed with a special Elks' luncheon and the Golden Anniversary Ball on the 15th. The intervening days were occupied with many pleasing programs, including an entertainment and card party, "Sister Lodge Night" including a floor show and a buffet supper, a family turkey



D.D. W. C. Ragsdale, second from left, presents to E.R. Clarence O. Gradin of Abilene, Texas, Lodge, the trophy won by that lodge for recording the greatest increase in membership during 1955-56. Looking on at left is Membership Committee Chairman Dr. J. C. Shipman, and at right, immediate P.E.R. William T. Callaway.



Gene Davis, former Chairman of the Colorado Elks Ritualistic Committee, presents the John R. Coen Ritualistic Award to E.R. Harry H. Cable of Salida, Colo., Lodge. The team, which won the State title consists of, left to right, candidate Harold L. Thonhoff, Mack Witty, Laurence Camp-ton, E.R. Cable, Milton Smith, K. E. Barnhill, Hubert Fox and Sammy DeLeo.



Nashville P.E.R.'s Fred J. Beesley and John T. Nolan discuss Memphis, Tenn., Lodge's observance of "Know Your America Week" with State Assn. Pres. Henry W. Beaudoin and Gov. Frank G. Clement. The event was covered in the newspapers and by WSIX-TV.



Scranton, Pa., Lodge's Secy. for 63 years, William S. Gould, second from right, is congratulated by City Clerk Sam Druck during the lodge's observance of Mr. Gould's 85th birthday. Others, left to right, are J. P. Dennebaum, E.R. I. E. Cunningham, Sr., and Mr. Gould's brother, Alfred.

Mr. Merrill reports, with a population of over 30,000. Twice this community has been destroyed by fire, the last time in July, 1923, and its inhabitants now number only about 200. Mine production has practically ceased, although one will re-open occasionally; as a matter of fact, a mine is now being reactivated, and the community lives in the hope that new methods will once again make mining a profitable enterprise there.

The members of Goldfield Lodge are widely scattered, yet they continue to support the lodge in all its activities and refuse to dimitt to other lodges. This loyalty to No. 1072 was given evidence to D.D. Merrill when one lodge member and his wife drove over 160 miles to take part in his official visit to Goldfield, and several others traveled from 30 to 60 miles to be present on that occasion. The lodge hall in Goldfield is used by all churches of the community, for most funerals and for all occasions requiring quarters of that type, since it is the only hall that is

available for such purposes in Goldfield.

Mr. Merrill states further that the lodge's Inner Guard is 87 years old and its Secy. and custodian is 78, but he "envies their vitality". The membership has fallen off on the average of five or six members a year, yet the lodge's financial status has been increasing for several years. Its income is augmented by rental to the U. S. Postal Department, with the local Post

Office occupying part of the ground floor.

Goldfield Lodge has the first Life Membership card presented to its first Exalted Ruler, hand engraved on solid gold about 1/32 of an inch thick; it also has a gold-inlaid ivory gavel that opened the Grand Lodge Convention in Philadelphia in 1907 which its members hope will be used to open the Grand Lodge Session in San Francisco in 1957.



Above: One of the largest classes to be initiated as a "Salute to Grand Exalted Ruler Fred L. Bohn" was this 91-man group brought into Elkdom by Exalted Ruler Edward R. Dimbat and his fellow officers of Salem, Oregon, Lodge. The event took place in the presence of State Association Vice-President Warren D. Randle and D.D. Fred Simpson.

Below: Kingston, N. Y., Lodge recently presented wheel chairs to Kingston Hospital, the Benedictine Hospital and the Elks National Home in Bedford, Va. With one of the gifts are, left to right, E.R. Frank H. Simpson, Kingston Hospital Adm. Robert Schnitzer, Sister M. Berenice of the Benedictine Hospital and Past State Pres. Wm. F. Edelmuth.



The three Jewell brothers, who were initiated into Galveston, Texas, Lodge as part of its 17-man Grand Exalted Ruler's Class are pictured with their proposer, E. V. Miller, right. The brothers are, from left to right, Sam, Virgil and Homer Jewell.

LINGUAPHONE

MAKES IT EASY TO LISTEN and LEARN to Speak

SPANISH (American or European) • **FRENCH**
GERMAN • **ITALIAN** • **JAPANESE**
MODERN GREEK—34 languages available
for FREE TRIAL AT HOME

Only LINGUAPHONE, The World's Standard Conversational Method, brings 8 to 12 of the world's best native language teachers into your home. By listening to Linguaphone's fine, life-like, conversational recordings for only 20 minutes a day, you can learn another language AT HOME—the same easy, natural way you learned to speak English long before you went to school. It's like living in another land. You Listen. You hear native men and women converse about up-to-date, everyday matters. You Understand. You SPEAK. You acquire a true accent, no TEXTBOOK CAN TEACH. Exciting Business, Travel Opportunities Here and Abroad. Linguaphone is used around the world by schools, governments, business firms. Over a million home-study students have learned another language this ideal way. Stop Wishing—Start Talking! Send for FREE Book and Details of FREE TRIAL. Linguaphone Institute, T-291-027 Radio City, New York 20, N. Y.



New Way To Sleep

Tee-PJ's resemble a T-shirt, but are over a foot longer. Rib-knit, soft combed cotton. Gives when you move, eases up when you relax. No bind, no bunch, no chafe, no buttons! If not most comfortable sleeper you've ever worn, return within 7 days for full refund and we send you regular T-shirt FREE!

S(34). M(36-38). L(40-42). XL(44-46).

\$2 ea. 3 for \$5

NOW! Tee-PJ's available in long sleeves with knit wristlets for colder weather comfort.

\$3 each. 2 for \$5
 ALL POSTPAID

WITTMANN TEXTILES
 6505 S. Dixie, Dept. 280
 W. Palm Beach, Fla.



Sudbury FLEA-SCAT PAD

Kills Fleas and "B.O."

"It's wonderful—kills fleas and doggy odor while I snooze. I love its cedar aroma, its clean comfort." Protects children. Stops scratching. Ends all struggles with messy powders, sprays. Keeps pets off chairs, sofas. No more dog hairs. Pleasant in any room. Economical, long-lasting. Flea-Scat-Pad, 15x28 in., \$3.49. Super size, 28x36 in., \$4.98. Kitty Cootie-Chaser the pad for Cats, 14x18 in., \$2.49. Send check or M.O. and we pay postage. Money-Back Guarantee. Sudbury Laboratory, Box 92F Sudbury, Mass.

YOURS—THE YEAR'S MOST EXCITING STAMPS!



Grace Kelly - Rainier Royal Wedding; Monaco U. S. President Set - F.D.R., Lincoln, Washington, Eisenhower.

plus an imported collection of 310 STAMPS
 all yours for only **25¢**

You also get Bulgaria Complete Motor Show; St. Thomas Explorer; San Marino Airmail Triangle; Dutch New Guinea, 1st Stamp Issued and hundreds more! Grand total of 315 all-different stamps. Catalog value \$6.95—yours for 25¢ to introduce our Bargain Approvals (returnable). Included FREE, Midget Encyclopedia of Stamps.

Send 25¢ Today. ASK FOR LOT FR-17

ZENITH CO., 81 Willoughby St., Brooklyn 1, N. Y.

Elks Family

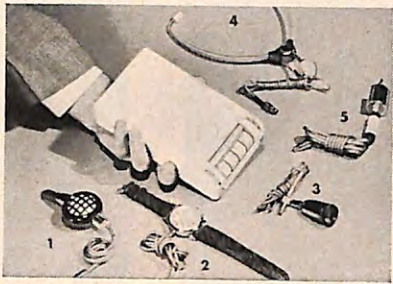

NEWEST ELECTRONIC WONDER is a Pocket Recorder, the Minifon. Self-contained, push-button unit, carried in pocket, records 4 hours through grill (1), wrist watch (2) or telephone (3) mikes. Plays back through stethoscopic earphones (4) or phono attachment (5). About \$289. For brochure, write Lincoln Electronics, 1305-K Lincoln Bldg., New York 17, N.Y.



BATHTUB SOAKERS can relax luxuriously, head comfortably supported by Relaxabath Pillow. Air-cushioned, and uniquely contoured to rest neck and head, it's adjustable for height and softness. Two suction cups hold it firmly against tub or wall. 100% waterproof vinyl. 9" x 15". Folds compactly. \$2.25 ppd. Better Sleep Inc., Dept. E2, New Providence, N. J.



SNO-CHASER keeps car windshield free of snow and ice, and gives you clear, safe-driving vision. One side is a plastic-bristled brush to sweep off snow. Turn it around and remove ice, frost and "fog" with the sharp blade and rubber squeegee. 24" long handle. Comes in 3 sections for easy storing. \$1.00 ppd. Laurie & Co., Dept. E, 507 Fifth Ave., New York 17, N. Y.

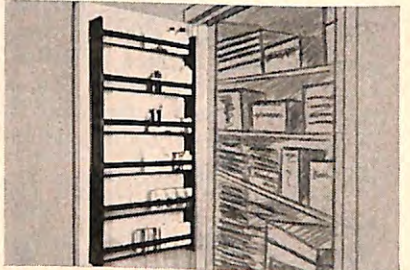

DOOR CADDY takes the overflow of bottles, jars, cans from pantry, cupboard and medicine cabinet. This space-saver attaches to the back of any door. Its six shelves are adjustable from 11" to 20" wide and guard rails keep contents safe. Made of aluminum, 40" high, 3 1/2" deep. Only \$6.95 ppd. Elron Inc., 225 West Erie Street, Dept. E, Chicago 10, Illinois.

Merchandise shown on these pages can be ordered direct from the companies listed. Enclose a check or money order.

KEEP CESSPOOL TROUBLE AWAY



WITH **NORTHEL**

Suburban & Country Dwellers

NORTHEL Reactivator keeps septic tank and cesspool clean. A bacteria concentrate breaks up solids and grease—prevents overflow, back-up, odors. Regular use saves costly pumping or digging. Simply mix dry powder in water, flush down toilet. Non-poisonous, non-caustic. Guaranteed to reactivate septic tank, cesspool. Six mos. supply (23 ozs) only \$2.95 ppd. Northel Distributors, EM-2 P. O. Box 1103, Minneapolis 1, Minn.



for **AULD LANG SYNE**

For that worthy member who can point to 25 years of membership in the Elks here is a gift that he's sure to prize highly as a token of the many years he has been an Elk and for the whole-hearted warmth of feeling it expresses. Yes, 25 years IS a long time and well warrants recognition and there's scarcely a better way to show this than by giving that Elk one of these handsome, 10 kt gold, splendidly enameled red, white and blue 25 year membership pins. A Christmas gift unusual. 10 kt gold plated post and attaching button. Please order by number. 25 year pin No. 3—\$8.25. Price includes Federal tax. For N. Y. City sales add 3% tax. Delivery within 2 weeks. Order TODAY from THE ELKS MAGAZINE, 386 Fourth Ave., N. Y. City 16, N. Y.

Shopper

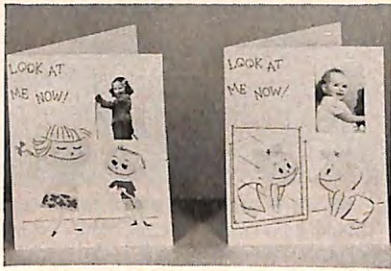

"LOOK AT ME NOW" Photo Greeting Cards keep relatives and friends in close touch with your youngsters from babyhood through teens. Each card is printed in four colors, has appropriate message inside. 20 cards, matching envelopes and 20 reproductions from photo or negative, returned unharmed, \$1.25 ppd. Bell Studios, Dept. E, General P. O. Box 1000, New York 1.



CHIC CHIGNON of human hair. For a smart new coiffure suitable for day or evening, we love the gentle look of this hair piece. And it covers those awkward or brittle ends. Guaranteed to match your color sample. Only \$7.50 ppd. Light blonde, auburn or mixed grey, \$3.25 extra. Send hair sample to Fashion Hair Products, 175 Fifth Ave., Dept. EVZ, New York 10.



SET UP A SERVING SPOT in your living or dining room and you'll marvel at the work it saves. This two-tiered 33" high stand holds dishes for display and easy service. The smart wrought metal looks substantial yet is light enough to carry from room to room. In white, gold, pink, turquoise, black. \$10.95 exp. chgs. coll. Unique Gifts, Box EK, Glen Ridge, N. J.



GREEN GROWS YOUR GARDEN all year long in this Indoor Greenhouse. Provides the proper humidity so necessary to successful indoor gardens. Of vinylite material, it comes complete with base and collapsible wire frame, and includes a sheet of Vinyl for window sill protection. 9" wide x 24" long x 18" high. \$4.95 ppd. Downs & Co., Dept. E, Evanston, Ill.

Except for personalized items, there is guaranteed refund on all merchandise returned in good condition within 7 days.

BUY DIRECT and SAVE UP TO 1/2
on ITALIAN ACCORDIONS
EASY TERMS



Act NOW!

Accordions of famous makes and breath-taking beauty now can be yours! Mail coupon for FREE Color Catalog and amazing Wholesale Prices. Special offer for limited time only.

5 DAYS FREE TRIAL

MONEY BACK GUARANTEE

MAIL COUPON NOW

TRY BEFORE YOU BUY

World's largest selection direct from Importer to you! 30 models to choose from. SATISFACTION GUARANTEED or your money back. Trades-ins accepted. Terms low as \$10 monthly. Write today!

Big Color Catalog FREE!

Send me FREE Color Catalog—full details.

Name _____
Address _____
City _____ State _____

ACCORDION MANUFACTURERS & WHOLESALERS OUTLET
2003 W. Chicago Ave., Dept. K-27, Chicago, Ill.



MORE BRILLIANT THAN A DIAMOND!

Amazing Gem Discovery! Has more sparkle, more fire—looks exactly like a fine diamond. Your friends will think you are wearing the most glorious diamond they have ever seen. Dazzling 1-carat lady's ring only \$54. Also superb men's and ladies' rings in larger carat sizes. Easy payments. Write today for FREE illustrated booklet. Write to Kenya Gem Corporation, Department 312, Philadelphia 44, Pa.

PRESERVE PHOTOS



cards,
clippings,
mementos
in CLEAR
PLASTIC

New, easy to use, home kit saves you 75% on plastic laminating. Just lay subject between 2 sheets of PLAIN-VU laminated clear plastic—press down, and you have the favorite snapshot, membership card, identification, recipes, etc., permanently imbedded in 100% transparent plastic. Its flexible and durable—won't discolor, harden or deteriorate—lasts indefinitely. No machines, tools or heat needed. The PLAIN-VU kit contains everything you need. Order now. Jr. Kit—10 sheets (3" x 4") only \$1.00 postpaid. Special introductory kit—10 sheets 3" x 4"; 6 sheets 6" x 8" and 2 sheets 10" x 12" only \$4.50 postpaid. Satisfaction guaranteed. Send check, cash, or money order to:

PLAIN-VU Dept. D, Box 83 Mentor, Ohio

Why let those good positions go to somebody else?
LEARN AT HOME

MATH for the Practical Man

AMAZING NEW METHOD
teaches you QUICKLY, EASILY

You need MATH to step into the hundreds of positions at **FAMILY-MAN SALARIES** in the Classified Ads daily!

Send today for the Math Course that can change your future! FREE for 10 days! Arithmetic, Algebra, Geometry, Trigonometry, Calculus—5 volumes, cloth-bound, 200 to 342 pages each—VALUE \$14.75—with this ad, only 9.85. Just write your name and address in margin and send to: D. VAN NOSTRAND COMPANY, Inc., Publishers—120 Alexander St., Princeton, N. J. You'll learn Math easily—or return within 10 days without obligation. ELK 2-57

You will ENJOY pleasant, vigorous **VIBRATORY MASSAGE** with the Genuine **Battle Creek HEALTH® BUILDER**



"TOPS" for the Home, for Athletic Clubs, for Reducing Salons—for MEN and WOMEN!

Enjoy the relaxing, stimulating benefits of efficient vibratory massage! Health Builder gives you pleasant, scientific deep-tissue manipulation—"at the snap of a switch." Helps weight and figure problems, muscle-toning, blood circulation. Widely used in Health Institutions. Built for years of service—fully guaranteed. WRITE today for literature and new booklet, "BE GOOD TO YOURSELF!"

Battle Creek EQUIPMENT CO.
Battle Creek 15, Mich.

GET YOUR COPY



SEND FOR Free Record

START SPEAKING FRENCH OR SPANISH ALMOST OVERNIGHT!

HERE'S the easiest way to learn FRENCH, SPANISH, Russian, German, Italian, Japanese or Brazilian. Listen to FREE 2-sided non-breakable record. Let your eyes follow words in FREE sample lesson. Almost at once you'll be chatting in a new language with a perfect accent! That's all you hear! No dull, tedious work. Just listen—imitate! It's that easy! Offer may end soon. Rush 10c to help cover cost of special packaging, shipping. State language you want. We'll also send free information on full Cortina course. No obligation. **CORTINA ACADEMY**, Dept. 422, 136 W. 52nd St., New York 19.

Jung's GIANT GLADS

WILL AMAZE YOU WITH THEIR SIZE AND BEAUTY. SPIKES 3 TO 4 FEET TALL. Bulbs guaranteed to bloom.

50th ANNIVERSARY SPECIAL!
49c VALUE ONLY 25c

As a special inducement for you to plant Jung's famous Seeds, Bulbs and Plants, we will send you 6 of these grand Gladioli, one Flaming Red Begonia and a pkt. of the Brilliant Blaze Zinnia, the "All America" Winner, all for 25c. We will also send, if requested, our color catalog of bargains in Seeds, Bulbs, Plants, Shrubs. Premium Coupon in every catalog.

J. W. JUNG SEED COMPANY

Dept. 64 Randolph, Wisconsin

GET A KICK OUT OF WRITING With the New "LEG"

RETRACTABLE BALL POINT PEN

Everyone will get a laugh when you sign your name with this novelty pen. Made of highest quality flesh colored plastic it actually looks and writes like a dream. Standard refills are available everywhere.

\$1.00 Ppd. (2 for \$1.95 Ppd.)

Pa. Residents Add 3% Sales Tax
Send For Free Gift Catalog

TAYLOR GIFTS Wayne 4, Pa.

Chrome Vanadium 29 Pc. DRILL SET

Specially made for speed drilling. In sturdy plastic steel drill roll. Finest alloy steel drills hardened and precision ground to the sharpest, longest lasting cutting edge obtainable; will easily and cleanly bite through hardwoods, plastics, aluminum, iron and the toughest steels. Full jobber length. Sizes by 64th from 1/16" to 1/2".

\$6.49 ppd.
\$8.95 ppd.

60 Pc. SET WIRE GAUGE CHROME VANADIUM DRILLS

Top quality high test Chrome Vanadium Drills designed for speed drilling through toughest steels, woods, plastics, iron and aluminum. Precision ground, long-lasting cutting edges. Nos. 1 through 60. A \$14.95 value—NOW Same set above available with Huot Index container. Also available 61-80 set of high quality drills in plastic kit with marked pocket for each drill. All above drills sets plus 35c pp. & hdgr.

\$5.40
\$6.65
\$2.50

FINEST QUALITY IMPORTED PRECISION PLIERS

Flat Nose, Round Nose, Diagonal, End Cutting, Side Flat—1 Side Round, Snipe, Combination For jewelers, Optical Workers, Hobbyists. These German instruments are of deep-forged, heat-treated high quality tool steel, fabricated to most exacting specifications. All-over ground, polished to smooth hard surfaces. Smooth working joints with right tension. Jaws meet perfectly to securely hold the most delicate objects in hard-to-reach corners and angles. Each plier is 4" long.

75c EACH. ALL 7 FOR \$5.00 ppd.

Minimum order \$1.00. Send check or M.O. C.O.D. plus fee. Money Back Guarantee.

SCOTT-MITCHELL HOUSE, INC.

Dept. 51-B, 611 Broadway, New York 12, N. Y.

Elks Family Shopper



CABINET FILE for home or office. Keep records safe and neat in the roomy top (equipped with A-Z index folder). And keep stationery and supplies handy in the six drawers below. All steel in hammertone gray, green or walnut finish. Letter size, 12 1/2" wide, 30" high, 10" deep, \$14.95; Legal size, 16" wide, \$17.95. Shpg. charges collect. Elf Hollow, Dept. E, Box 65, Watertown, Conn.



LEATHER WALL THERMOMETER. It's dual purpose because it tells you the temperature and brightens a dull or empty-looking stretch of wall. The dial face is easy to read and it's pleasingly decorated with a gold-tooled fleur-de-lis design. In red, green, brown, maroon, ivory, rose, light blue or black. 7 1/2" x 2". Gift boxed. \$1.00 ppd. Matthew Day Co. Inc., Dept. E, 34-13 Bdwy., Fair Lawn, N. J.



HIDE-A-WAY TELEPHONE INDEX keeps names and numbers handy but snugly out of sight, clipped under base of telephone. Calldex slides out easily to reveal indexed, ruled sheets (A to Z). Room for about 300 names. Overlay of clear plastic protects listings. Refills available. \$1.00 ppd. Travers Merchandise, Dept. #1, 309 Travers Ave., Mamaroneck, N. Y.



PROUD PAPA and Proud (or Proud-er?) Grandpa deserve these Special Achievement Cups. They make a very handy and amusing desk accessory too for cigars, cigarettes, pencils, or whatever. So when a new baby appears, remember Papa and Grandpa. Ceramic Cups, \$3.50 ea. ppd. Wales Luggage Corp., Dept. E, 540 Madison Ave., New York 22, New York.

You'll like a HANCOCK PEDESTAL GRILL!



Large 15" x 22" cooking surface. Burns wood or charcoal.

Send 10c for easy step-by-step plans for brick or stone enclosed models. Complete catalog included.

... it's rugged, easy-to-install, swivel-mounted. A real backyard beauty! Genuine cast iron fire grate—won't burn out. Wide drop shelves... controlled draft and many other features. Only \$37.50, f.o.b. Pontiac. Order today. **MONEY BACK GUARANTEE!**

HANCOCK IRON WORKS

52 W. Pike St. • Box 13-207 Pontiac, Mich.

SAFETY FOG FILTER



This amber plastic filter when placed over your headlight will penetrate fog, snow, dust or rain far better than anything yet devised. This filter is designed for emergency use to give maximum efficiency with minimum loss of light. Easy to attach—easy to remove.

\$1.00 Pair Postpaid

U.S. Patent No. 2530685

SAFETY FOG FILTER CO.

116 So. Pritchard, Dept. E FULLERTON, CALIF.

1000 Name & Address Labels \$1.00



Mrs. Arthur H. Robinson
1035 Thurlam Avenue
Rochester, New York

Your name and address printed on 1000 fine quality gummed labels. PACKED IN PLASTIC BOX. Use them on stationery, checks, books, greeting cards, records, etc. Your choice of 3 lines printed on fine quality gummed paper. Six orders for \$5. THIS IS A SPECIAL OFFER. A sensational bargain. Ideal for gifts. Makes a wonderful, useful present. Satisfaction guaranteed. **HANDY LABELS**, 206 Jasperson Building, Culver City 1, California.

DEER HUNTERS! ENFIELD RIFLE SALE

We have made a special low cost purchase of surplus British Lee Enfield Army rifles. They are one of the world's most accurate rifles and ideal without any further expense for deer, bear and any North American or African big game. Adjustable sights, 10 shot, bolt action, barrel 25" wt. approx. 8 1/2 lbs. These guns have British ordnance and proofhouse marks. Thousands used by U.S. hunters. All bores are guaranteed in good condition. 303 softnose ammunition is made by Rem. Win., Western and Peters, always available everywhere. We remove cosmoline and re-oil lightly before shipping. Sling included. Bayonet, \$1.95 additional. We have softnose ammo, 20 rds. for \$2.95; military target ammo, 100 rds., \$7.50.

JUST \$19.95



TO ORDER: Send check, cash or money order. 1/2 deposit for C.O.D. Shipped express collect. Pasadena, Calif. Calif. res. add 4% state tax. 10 day unconditional money back guarantee.

THE ELLNER COMPANY
Dept. L 1206 S. Maple Avenue, Los Angeles 15, Calif.

Elks Family Shopper



COOK ROTISSERIE-STYLE right in your oven and produce tasty dishes like shishkebab. Unique Shishkebab'r fits in broiler of most any oven, can be used for meat, fish or fowl. Take it outdoors in summer for campfire or grill. Nickel-plated, steel, it stands 5 1/8" high on base 11" x 10 7/8". Folds flat for storing. \$3.00 ppd. incl. 2 spears, recipe booklet. Taylor Gifts, Dept. E, Wayne, Pa.

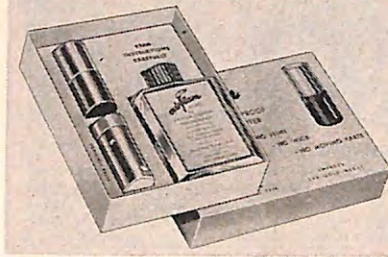

WINDPROOF LIGHTER uses no flint, wick or battery. It lights up when you remove the cap, exposing platinum and silver filament to the air. Fills easily from bottom. A handsome Valentine gift, it comes gift-boxed. \$3.95 ppd. includes extra cartridge and special Airflam fluid. Extra 6 oz. fluid, \$1.25. Foeller Co., Nameplate-Lighter Div., Dept. E, 1716 Deckner Ave., Green Bay, Wisconsin.



GLASSES SLIP AND SLIDE down your nose? Ear-Loks will keep them up where they belong. Soft, invisible tabs, they easily attach to ear pieces of all plastic shell-type frames to hold them securely in place. Order AA for wide, AB for medium, or AC for narrow frames. 2 pairs for \$1.00 ppd. Mrs. Dorothy Damar, 720 Damar Bldg., Elizabeth, N. J.

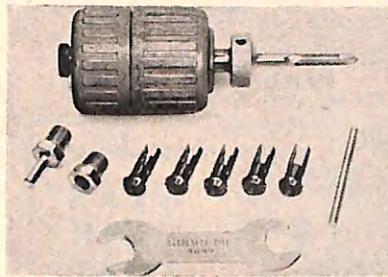

PUSH-PULL POWER TAPPER. When attached to any portable or regular power drill, it instantly reduces speed 7:1 on forward motion. A gentle pull reverses spin down to 6:1 ratio. Drives taps up to 5/16" in diameter. With wrench pin, 5 collets, spindle adapter, chuck adapter and bushing wrench, \$29.95 ppd. Scott-Mitchell House, Dept E, 611 Broadway, New York 12.

If Your Child Is a Poor Reader

See how The Sound Way To Easy Reading can help him to read and spell better in a few weeks. New home-tutoring course *drills* your child in phonics with records and cards. Easy to use. University tests and parents' reports show children gain up to *full year's grade* in reading skill in 6 weeks. Write for free illustrated folder and low price. Brenner-Davis Phonics, Dept. E-19 Wilmette, Ill.



CUPID'S ARROWS for your Valentine **SOMETHING SPECIAL**—Intriguing Earrings look as if they are really piercing the ear. Actually, screw back on 1" long arrow slips behind lobe. A gay illusion designed by Chief Blue Sky Eagle. Order a pair of each. **STERLING SILVER \$2, GOLD Plated \$2, COPPER \$1** Order by mail today. Send cash, check or m.o. Box 4035, Dept. 1-EK Tucson, Arizona

BIG COLOR PRINTS

ONLY **25¢**
3 1/2 x 5
FROM **KODACOLOR FILM**

DEVELOPING
ONLY **75¢**
PER ROLL
Minimum Order \$1
No C.O.D.'s
All Orders
Returned 1st Class

COLOR PRINTS from KODACHROME - ANSCOCROME - EKTACHROME 2x 3x 5 x 7
25c 45c \$1.00
Anscochrome - Ektachrome 135 - 120 - 620
\$1.00 DEVELOPED & MOUNTED
KODACHROME \$1.25 per roll
SATISFACTION GUARANTEED
Write for Free Folder Mailers
CUSTOM COLOR LAB
Dept. 27, Framingham, Mass.

TEXAS 56
XX0000

New! . . . Unbreakable
NUMBER PLATE FRAME

Snaps on in a jiffy. Decorative, flexible plastic can't rattle or scratch. Fits all standard 6" x 12" plates. Available with or without Elks Emblem. Colors: Black, White, Red, Yellow, Green or Blue. Please specify color.

with emblem **\$1.50** Pair
without emblem **\$1.25** Pair

Postpaid. No C.O.D. please! Money back if not satisfied.
BROCK'S NOVELTIES
P.O. Box 151 Lunenburg, Mass.

YOUR OLD FUR COAT MADE INTO **\$22.95** TAX FREE
NEW 1957 CAPE STOLE OR JACKET

MORTON'S RESTYLING INCLUDES: NEW LINING • INTERLINING • MONOGRAM • CLEANED • GLAZED

Choice of 30 HIT STYLES

Morton's is world's largest and oldest one-price fur service. Morton's Fur Service is most praised by style magazines. Widest choice of styles all \$22.95. Whether your coat is outworn or just out-of-style you'll be delighted with Morton's glamorous restyling. Write To:

MORTON'S Dept. 45-B Washington 4, D. C.

Mail Coupon to: MORTON'S
SEND FOR FREE 12 PAGE STYLE BOOK
NAME: _____
ADDRESS: _____
CITY: _____ STATE: _____
In New York: Visit Morton's Showroom, 225 W. 34th St. Phone Bryant 9-3200

A GIFT HE'LL ALWAYS CHERISH

Other gifts he will get but this, a handsome 10kt Gold, richly enameled Elks insignia is one he will treasure for years ahead. Please order by number. No. 5 (above) 15 year pin, 10kt gold, red, white and blue design. Post and attaching button gold plated. Price \$7.35. No. 4 slightly different design as No. 5 but with 10 year membership designation also \$7.35. Prices include Federal tax. Delivery within 2 weeks. For N. Y. City purchase add 3% sales tax. Order your gift pin today from **THE ELKS MAGAZINE, 386 Fourth Ave., N. Y. City 16, N. Y.**

FREE CATALOG!
BUY GENUINE **Diamonds**

From New York's Leading **DIAMOND SPECIALIST**
SAVE UP TO 50% AND MORE
Buy For Cash or Easy Credit PLAN

Tremendous savings on diamonds from unredeemed loans, bankruptcy sales and other below market sources. All reset in smart brand new 14 Kt. gold & platinum modern mountings. One of the world's largest selections. Every diamond graded according to nationally accepted system. Grading explained in catalog. You are 100% protected by a SWORN BOND guaranteeing quality and 10 DAY UNCONDITIONAL MONEY BACK GUARANTEE. Easy payment lay-away plan, and . . . see-before-you-buy plan available. Send coupon for FREE CATALOG. Established 1882. Our references: your own bank or any mercantile agency. No Salesman Will Call.

KASKEL'S 41 West 57th St. New York 19, Dept. 767-B
Send FREE CATALOG and Advice about DIAMONDS without obligation.

NAME _____
ADDRESS _____
CITY _____ STATE _____



Relaxing Comfort

A
Perfect
Gift

This ingenious Knee Lift Cushion gives you contour chair and hospital-bed comfort, achieved by slightly flexing the knees. Now this comfort can be enjoyed in your own home. Your back, hips and legs relax, tensions vanish, sleep comes easily and naturally. Wonderful gift for restless sleepers, bed readers, invalids and during pregnancy. Used by many doctors and hospitals. Money back guarantee. Immediate delivery. Only \$2.98.

BETTER SLEEP Inc., Dept. 470, New Providence, N.J.

WROUGHT IRON SWITCH PLATES

ATTRACTIVE PRACTICAL and DURABLE electric switch ornaments.

Designed to add warmth and beauty to the walls of any styled home from Provincial to Modern. These handsome black wrought iron scrolled-framed plates fit over any wall switch or outlet. Give added protection to walls from finger marks. Ideal for any room. . . Living Room, Kitchen, Bed Room, Den, Foyer, etc. #1 Single Switch \$1.35 ea. #2 Triple Switch \$1.95 ea. #3 Duplex Outlet \$1.35 ea. #4 Double Switch \$1.65 ea. #5 Combination Switch and Outlet \$1.95 ea. Other types available including Despard Plates No C.O.D.'s please. We pay postage. Money refunded if not delighted. Order NOW!

Write for FREE Gift Catalog

Laurel & Co. Dept. E-20, 507 5th Ave. New York 17, N. Y.



WOMEN'S FULL & HALF SIZES
3 1/2 to 13
AAAAA TO EEE

"Most comfortable mocs I ever had" —says Mrs. R. A., Cincinnati, Ohio
Walk on air in foam-crepe soled mocs, hand-laced, flexible. Top-grain leather, smartly styled. Extra-light. For work or play. Red, Brown, Smoke, White. Fine value, direct from manufacturer. \$4.95 plus 50¢ postage. Moccasin-Craft, 65-EB Mulberry, Lynn, Mass.

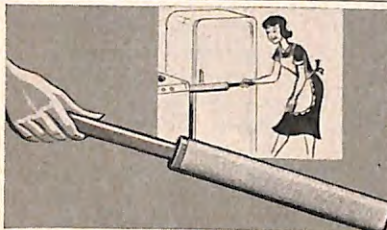

REACH-ALL SPONGE CLEANER

It's a snap to get into those hard-to-clean tight spots with this long, slender cleaner. You can actually wash under, between and behind sinks, stoves, refrigerators, radiators, cabinets, etc. 28" long cleaner has 18" of durable foam sponge firmly attached to its wooden handle. No flying dust, just dip in suds and wash tight spots clean! 98¢ Postpaid. No C.O.D. Guaranteed, of course.

ELRON, INC.

225 W. Erie St. Dept. A-250 Chicago 10, Ill.

New Accent!

WEAR MINK TIES!

Mink for your 'high-livin' moments. Select from 3 shades, Silver Blu, Royal Pastel or Ranch Brown. Western Bow Tie, 4.50. Oxford Bow, 3.50. Cuff Links, pr. 3.50. Deduct 10% on orders of 12 or more (any assortment). NO COD's, please. Send check or MO to THE ROOT CO., PO box 3126-k, Santa Ana, California.

Only TWO \$5 Jobs a Day At Home

PAYS \$240⁰⁰ A MONTH!

BEFORE INVISIBLE REWEAVING

Makes Cuts, Tears, Holes DISAPPEAR from Suits, Coats, Dresses — ALL FABRICS! Fabricon Reweavers who do only two \$5 jobs a day can earn \$240.00 a month. And a \$5 job can be done at home in about 1/2 hour by an expert Fabricon Reweaver. In many communities qualified reweavers are scarce; service is expensive—often unavailable. Can you learn to do this fascinating, profitable work? Can you earn \$240 monthly in your community? We'll tell you what it takes to learn invisible reweaving; we'll tell you what to do to check the opportunity for profit in your town. Get the answers to these questions free... and complete information too... all free! Write for details today!

FABRICON CO., 8342 S. Prairie Ave., Dept. 751, Chicago 19, Ill.



DOCTORS, LAWYERS, MERCHANTS, CHIEFS are wearing half Wellington boots made by Justin of Texas since 1879. Tan Ruff Out sport or work boot. Neo cork soles \$14.75. Brown or Black kid Dress boots \$17.85. Sizes 5 to 13; widths AA, A, B, C, D, E, EE. Check or money order, no C.O.D.'s. Prepaid. Oilfield Sporting Goods, 1001 N. Ventura, Ventura, California.

Free! Fabulous Collection from SOUTH of the BORDER

Get this big, valuable collection of genuine, all-different postage stamps from the exciting land of the mysterious Amazon . . . scarce airmails, gorgeous commemoratives, giant-sized stamps picturing wild horses, covered wagons, action-packed fights, native war heroes; PLUS sensational train stamp, beautiful "Christ of the Andes"; many others. EXTRA! Bargain Catalog, "Collectors' Manual" plus other exciting offers for your inspection. Send 10¢ for mailing costs. ACT NOW!

JAMESTOWN STAMPS, N2EM JAMESTOWN, N.Y.



Housebreak Your Dog Easily!

No more ruined carpets, no more spanking puppy! Just put two drops of HOUSEBREAKING SCENT on puppy's newspaper, box or on the grass and he knows that's the spot! You can completely train most mature dogs and puppies with one bottle or less. Guaranteed to do the job or your money back! Only \$2, postage paid. Order HOUSEBREAKING SCENT direct by mail from Sunset House, 696 Sunset Building, Hollywood 46, California.

Elks Family Shopper

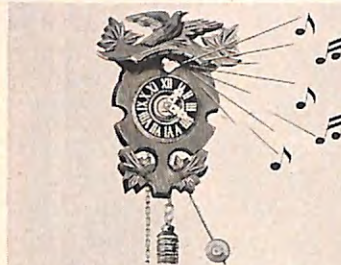

CUCKOO CLOCK, imported from Europe. Cheerfully chirping cuckoo greets you every 1/4 hour. Of hand-carved wood with antique walnut finish, clock has genuine weight and pendulum movement that keeps time accurately. 7" x 5". \$3.95, duty-free; 15¢ foreign packet fee coll. on delivery. Only 1 addressed to same person. Seven Seas Imports, Dept. G39F, 1717 Westwood, Los Angeles 24, Calif.



CASUAL SHOES for comfortable walking. Of soft, smooth glove leather, High Wedge Moccasins are soled with cushiony crepe. They're gored for perfect fit. White, cream, tan, red, turquoise or black with dainty bead design. White or cream only, if you prefer unbeaded. Sizes 3 thru 10, 1/2 sizes too. Narrow and medium. \$7.95 ppd. Old Pueblo Traders, Box 4035, Dept. EHW, Tucson, Arizona.

\$4,000.00 FOR 5¢ OLD MONEY WANTED

\$4,000.00 for 1913 Liberty Head Nickel. Unregulated Dollars 1804 to 1839, 1893-S, 1895-P, 1903-O pay \$100.00—\$5,000.00. Certain dates—Small Cents before 1915—\$325.00; Dimes before 1917—\$2,000.00; Quarters before 1924—\$1,000.00; Half Dollars before 1905—\$1,000.00; 2c pieces—\$70.00; 3c pieces—\$90.00; Half-dimes—\$500.00. Hundreds of others worth \$10.00—\$1,000.00. Canadian Coins—1921—5c Silver, \$50.00. 1889—Dimes—\$25.00. 1875 Quarters, \$50.00. 1921—50c—\$200.00. Wanted—20c Pieces, Gold Coins, Paper Money, etc. Our Large Illustrated Guarantee Buying—Selling Catalogue, Giving Complete Allein Information—Send \$1.00. Purchase Catalogue before sending coins. Worthycoin Corporation, Leaders Numismatic Quotations K-653-C, Boston 8, Massachusetts.

PORTABLE "GARAGE"

Protects against SUN, DUST RAIN SALT AIR

\$675

formerly \$9.00



A "Must" For Carports

In one month an exposed car can lose in value much more than the price of this low-cost car cover. Long lasting, reinforced plastic. Easy on and off. Special binding for extra security. Folds to small package, tucks into trunk beside tire. Specify make, model and year. Order direct. Send \$6.75 plus 35¢ postage or sent C.O.D.

Special for **\$1250** Reg. \$16

Extra heavy duty plastic **\$875** plus 45¢ postage Formerly \$11.00

Auto Industries, Dept. 17
208 East 46 St. New York 17, N. Y.

Elks Family Shopper

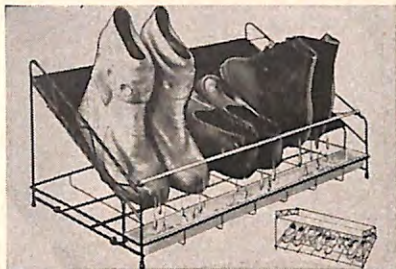

WET OVERSHOES A PROBLEM? Keep them in their place, neatly stacked in this brass-finish Overshoe Rack. Plastic trough catches drippings, snow and ice. Use it for wet umbrellas too. Extra shelf near bottom holds dry foot gear. 23" x 13" x 10 1/2", folds compactly for storage. \$5.95 ppd. Also in wrought iron finish, \$4.95 ppd. Clarion Prod., Dept. 92, Box 488, Highland Park, Ill.

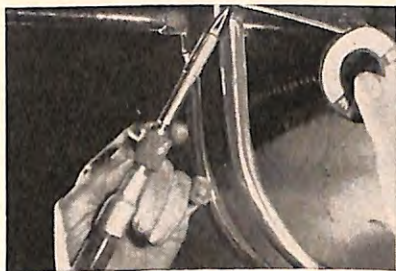

JET KING BUTANE BLOW TORCH. Pocket-size but its tiny, safe, clean charger gives 30 minutes of intense 3500° pin-point flame for soldering, brazing, plumbing repairs, etc. Just the tool for do-it-yourselfers and hobbyists. No dangerous inflammable liquid to store. With chargers, \$1.95 ppd. Extra chargers, 2 for 49¢. Meridian Co., Dept. E, 366 Madison Ave., New York, N. Y.



KEEP LEATHER LOVELY and new-looking longer. Keithone Leather and Luggage Cloth contains a chemical ingredient that cleans, polishes and protects leather and plastic against weather, scuffing and abuse. Use it on shoes, luggage, handbags and see how they shine. 10" x 18". Only \$1.00 each; 3 for \$2.00 ppd. Walling Keith Chemicals, Inc., Dept. E, Birmingham 1, Alabama.

Please mention The Elks Magazine when writing to our Elks Family Shopper Advertisers.



Play Right Away!

ANY INSTRUMENT

Now it's EASY to learn ANY INSTRUMENT—even if you don't know a single note now. No boring exercises. You play delightful pieces RIGHT AWAY—from very first lesson! Properly—by note. Simple as A-B-C. You make amazing progress—at home, in spare time, without teacher. Only few cents per lesson. 900,000 STUDENTS!

FREE BOOK Shows how easy it is to learn music this modern way. Write for it. No obligation; no salesman will call upon you. U.S. School of Music, Studio A1052, Port Washington, N.Y. (59th year).

"MY GREY HAIR IS A NATURAL LOOKING COLOR AGAIN!" says

JAN GARBER,
Idol of the Airlines

"TOP SECRET gives my grey hair a natural looking color!" says famous dance band leader Jan Garber. "I noticed results after just a few applications. And TOP SECRET is easy to use—doesn't stain hands or scalp. TOP SECRET is the only hair dressing I use."



A FAVORITE OF THE STARS
TOP SECRET has been a favorite with famous personalities for years. Exclusive formula imparts a natural looking color to grey or faded hair. Does not streak or injure hair; does not wash out. Send \$5.00 (Fed. Tax Incl.) for 8 oz. plastic container. (Convenient for traveling, too.) Ppd. No C.O.D.'s, please. Money back if not delighted with results of first bottle. Albin of California, Room 24, 1401-91 W. 8th St., Los Angeles 17, Calif.

FIX LOOSE CHAIRS WITH CHAIR-LOC

Nothing like Chair-Loc for quick, clean, easy home repairs. Penetrates and restores old, dry wood fibers... makes them S-W-E-L-L, locking chair rungs, dowels, legs, tool handles, pull knobs, ladders, mortise or dovetail joints TIGHTLY in place.

NOT A GLUE
Not necessary to take pieces apart to get everlastingly tight joints. Over 1/2 million sold to homes and cabinet shops.

SPECIAL—1/4 pint, with applicator and free instruction folder, \$1. ppd. Money back guarantee. Order now from

CHAIR-LOC, Dept. E27, Lakehurst, N.J.



HAND HOOK YOUR OWN RUGS THE TRUE, OLD WAY WITH WOOL RAGS

"THE DANBURY"

Design Size: 28" x 48" stamped in black outline on burlap, with all wool cloth in shaded colors for center flowers and leaves, book and instructions for shading.

only \$7.50 postpaid

SEND 25c FOR Illustrated Catalogue

REBECCA S. ANDREWS

Dept. E27 Walnut Ridge, Arkansas

NOW!
TEST YOUR OWN TV & RADIO TUBES

All of them even picture tube!

Checks fuses, appliances, etc. Easy, safe. Insert tube in socket. Pilot light indicates if tube needs replacement. Rugged metal case. AC or DC. One service call saved pays for tester. Only 3.95 ppd, or C.O.D. plus charges. DeLux model 4.95. Instructions. 5-yr. Guar.



GEIGER ENGINEERING CORP. Dept. G-1106
6349 N. Western Ave. Chicago, Illinois

YOUR OLD FUR COAT INTO NEW CAPE, STOLE!

STYLE #55



\$22.95 COMPLETE

ORDER BY MAIL 2-3 week delivery

Send for FREE Style Book

I. R. Fox, fur remodeling specialist, re-styles your old, worn fur coat regardless of condition into glamorous 1957 cape or stole. One low price, \$22.95 complete! This low, low price includes cleaning, glazing, repairing, lusterizing to new sheen, remodel completely, plus a lovely NEW LINING and INTERLINING & Monogram at no extra cost. The thrilling result—a luxuriously beautiful cape, stole or jacket. SEND NO MONEY!

Just wrap up your old fur coat, mail it to us now. Send your dress size and height on postcard. Pay postman \$22.95 plus postage when new cape arrives. Or send for FREE Style Book now! Many different styles to choose from. Write:

I. R. FOX, 146 W. 29th ST., DEPT. G-30, N. Y. C. 1, N. Y.

NEW POOL GAME

Everyone plays!
It's fun!



Only \$3.98 postpaid complete with balls and cues

LARGE 3 x 4 ft. reg.
Now you can have your own pool table! Just set this 3 x 4 ft. pool table frame on your rug and you're ready to play! Swell party game! Folds compactly—sets up in seconds. Comes complete with sturdy wood frame, six pool pockets with ball traps, ten numbered balls, two cues, and instructions on the different pool games. Send \$3.98 to: S & R RESEARCH, Box 15-T, San Gabriel, California

"TI" PLANT LOG

PLACE THE SHOOT IN WATER AND WATCH THE GREEN LEAVES GROW



Amazing Tropical

YOU CAN ALMOST SEE THEM GROW

"TI" PLANT LOG From Hawaii!
No "green thumb" needed! Just place Hawaiian "TI" plant log in water, peat moss or soil and watch it grow! Plant has a striking, palm like appearance (when fully grown) that adds a tropical effect wherever planted. Stays green year 'round, requires no care and its lush green leaves grow up to 2 ft. long! A luxuriant, rare Polynesian plant with a 1001 uses! Very fascinating! Just \$1.00 for 2 logs; 3 for \$1.25 postpaid; 6 for \$2.25; 12 for \$4.00. MONEY BACK GUARANTEE.
TOWER PRESS INC., BOX 591-FE, LYNN, MASS.



Make Yours A "No-Junk-Trunk"!
Carry-All TIRE COVER
Keeps Your Car Trunk Neat As A Pin

Here's a "housekeeper" that keeps your car trunk from looking like a dumping area! Handy clear plastic tire cover holds all your auto necessities in orderly arrangement... protects luggage and clothing from contact with wet or dirty spare tire. Actually makes your trunk roomier! Roomy pockets holds road maps, flashlights, flares, tools, polishing cloths, jack-handle, etc. within easy finger-tip reach. No loose tools to bounce around and rattle. Made of extra-thick, heavy-duty plastic with double-sewn seams. Fits over any size tire in all make cars. Slips on an off in a jiffy; doubles as your kneeling mat when changing tires. Exclusive—not sold in stores! Only \$1.39. Add 15¢ for postage and handling. Money-back guarantee. No C.O.D.'s, please. Order today!

Send For FREE Gift 'n Gadget Catalog
HOUSE OF SCHILLER Dept. E-51
180 N. Wacker Drive Chicago 6, Ill.



Tom Wrigley Writes from WASHINGTON



A DEFINITE CHANGE can now be discerned in America's preparedness policy. We have the H bomb but we are going to stop bragging about it. Chances are there will be very little testing of the horrible missile this year, if at all. The United States and Russia, which have the bomb, and other nations, too, realize that the price of another world war is now extinction. Scientists are agreed that the use of giant H bombs, possessed by both nations, would release such quantities of radium-strontium as to imperil all mankind. Preparedness charts now are placing more emphasis on guided missiles and in highly mobile engines of war, planes, tanks and subs. Uranium fission (atom bomb explosions) produce the deadliest poison known to man—Strontium-90. Explosions of A and H bombs from 1952 to date, it is estimated, have created some 40 pounds of SR-90 which is floating in the upper atmosphere, the stratosphere above 50,000 feet. Only time will lessen its deadly effects.

ARMY RETIRES PIGEONS

The Army's signal corps pigeons, many of them heroes of World War II and the Korean conflict, have been retired. Portable electronics made the birds obsolete. The Army likewise has gotten rid of camels (once used in the Southwest) mules

and cavalry horses. Only dogs survive the change over. There were 1,000 pigeons in the final closeout and they have gone to pigeon fanciers. Among the famous birds are "Yank", who made 90 miles in 100 minutes for General Patton in Europe, and "G.I. Joe", who covered 20 miles in 20 minutes in Italy in World War II, to carry an order to cancel a bombing operation. In World War I, the Army had 20,000 pigeons and one, "Cheri Ami", saved survivors of the Lost Battalion in 1918 by getting a message 25 miles in 30 minutes through battle fire, telling a battery to lift its fire on a Yank position. The bird got a wounded leg from a bullet during the flight. It was awarded the French Croix de Guerre and is now mounted in the National Museum here.

MEET A CALLIGRAPHER

Washington has a calligrapher, Mrs. Lawrence Imhoff, and she is perhaps the best in her profession, for there are only a few who know the art of fancy penmanship nowadays. She is the wife of a former Ohio Congressman and since the days of FDR has addressed invitations to White House functions and between times takes care of big diplomatic social affairs. Mrs. Imhoff uses a special off-set pen to produce shaded scroll effects. If she works 15 hours a day she can address 3,000 invitations. For the recent Presidential Inaugural Ball, Mrs. Imhoff addressed more than 7,500 invitations and everyone of them was perfect.

CANDIDATES WANTED

Congress in 1950 authorized a yearly "Young American Medal For Bravery." Last year no school, organization or parent nominated a candidate from the District of Columbia and Superintendent of Schools Hobart M. Corning says it is "downright embarrassing." How about your town?

NO COLD CURE

Scientists in Health and Welfare are working constantly to find a vaccine to kill the virus of the common cold, same as polio vaccine works on polio virus. As yet there is no cure for a cold. Aspirins and nose decongestants combat the symptoms. Those who take hot whisky, tea, and other things and in three days say they gave their colds a knockout are simply bragging. The cold generally leaves in a few days anyway.

BIRDS GET THE BIRD

Chemists who invent sprays good (or bad) for man, beast, plants and trees, have gone a step further. A bird can't roost in a tree without inspecting it first. In Washington the starlings have long been a pest

and among their favorite roosting places are trees along Pennsylvania Ave. where parades are held. So, to make the reviewing stands for the Inauguration Parade nice and safe, the trees were sprayed with a preparation. It is invisible, has no odor and isn't sticky. But it does have a secret ingredient which birds don't like. So they just get a whiff of something only birds can smell and off they go.

"MAMIE'S CABIN"

They call it "Mamie's Cabin" down at the Augusta, Ga., National Golf Club where the President and Mrs. Eisenhower like to sojourn, but don't let the name mislead you. The "cabin" is a three-story white brick and clapboard affair costing \$200,000 and built by wealthy members of the club. It has two living rooms, six bedrooms, seven baths and some other rooms. There is a big 27-inch TV set which rolls out of the wall. It has radiant heating and perfect air conditioning. For a cabin it's a wow.

OLD GEORGETOWN RUMPUS

Old Georgetown has rigid regulations covering remodeling of old houses to keep them looking as though George Washington just slept there. The Fine Arts Commission has just raised a rumpus over a made-over Colonial house in which a double window was built in a second-story façade when the permit called for a single window. It is hardly noticeable, but orders were issued to change it. Our forefathers didn't go for double windows, it seems.

POTOMAC PRETZELS

Washington zoo has just obtained six honest to goodness sea serpents, squirmy enough to give even a sober man the creeps . . . Internal Revenue Service can use 75 bright young lawyers, starting pay \$4,525 per year. Law School graduates not yet admitted to the bar can get \$3,670 . . . FBI Chief J. Edgar Hoover has the smallest calling card in Washington, 1½ x 3 inches . . . Mrs. Eisenhower doesn't like blue . . . Federal Civil Defense is training 800,000 volunteers in emergency mass feeding in case of disaster . . . The great Shrine of the Immaculate Conception, over a third completed at Catholic University, will cost \$14 million and be one of the world's 10 largest churches . . . The Capital has broad highways in all directions but government workers need 40 to 45 minutes to drive in from 16 to 18 miles . . . Candidates chalked up 220,000 miles in plane travel during the last election . . . You can buy hospital insurance for dogs here for \$15 a year, but you pay the first \$10 of the pup's care . . . Chinchilla breeders in session here report a market for 40,000 pelts in 1957.



FOUND



only in a bottle of Seagram's 7 Crown
 the perfection of American
 whiskey at its finest!

Say **Seagram's** and be **Sure**

SEAGRAM-DISTILLERS COMPANY, NEW YORK CITY. BLENDED WHISKEY. 86 PROOF. 65% GRAIN NEUTRAL SPIRITS.

TRAVELGUIDE



An informative letter from Brother Tom Connors was sent along to us after his recent trip to Mexico. He reports, "In Mexico on route 75 from Saltillo to Matehuala the map shows all-weather road. This is now completed and is without a doubt the finest highway in the country. A new extension of this highway is being completed from San Luis Potosi to Queretaro and will enable travelers to leave Laredo, Texas, and in two days be in Mexico City without the trial of mountains they now have on the Pan American Highway. Perhaps this will help some one on their trip to Mexico City." Thank you, Brother Connors, we are sure many of our travelers will benefit from your information.

★ ★ ★

The Greyhound Lines has greatly expanded its tour operations. A 13-day tour through North and South Carolina, Georgia and Florida's major resort areas is now offered for \$190.95. This includes transportation, hotels and sight-seeing trips. Trip leaves New York every Sunday. Other tours include 21 days to California, \$204; 16-day Gulf visits for \$147 and 31-day jaunts through the Northwest for \$290.

★ ★ ★

Additional helicopter flights on week ends from Los Angeles Airport to Anaheim-Disneyland and to Santa Ana-Orange Coun-

ty increases these flights to 13 each day. Fare is \$6.35, plus tax, in seven-passenger Sikorsky S-55's. This fare is reduced for trans-continental flights.

★ ★ ★

Swissair is planning about 20 conducted ski tours abroad to include many Alpine resorts in Switzerland, Austria, Germany, France and Italy. All flights are based on 15-day Trans-Atlantic excursion fare. Tours leave New York throughout the Winter and cost from \$591 up.

★ ★ ★

The situation in the Near East—Suez, that is—has made quite a difference in the comfort and ease of travelers to Europe this winter. No actual hardship, but considerable inconvenience. For example: gasoline in Italy is 85 cents a gallon, gas is rationed in Britain, Scandinavia and the Low Countries. French hotels will be chilly where oil is short. Ski resorts in most cases have good and ample fuel supplies and therefore not much discomfort as far as heat is concerned. What the summer of 1957 will offer the European tourist is anyone's guess.

★ ★ ★

On this side of the water it stacks up about as follows: Miami hotel, motel and apartment rates have been increased about 3 per cent this year. The Caribbean will have a great many additional tours this year as Trans-Atlantic and Mediterranean ships shift to the Caribbean. The accommodations in the islands have been increased about 25 per cent for this year's travelers, with most rates about the same as last year. In Mexico all the better hotels report that they are sold out for the winter season and in Hawaii, with additional hotel and ship space available, a gala season is in progress. Ski resorts have generally in-

creased their rates in California, New England and Canada.

★ ★ ★

Speaking of skiing, winter sports enthusiasts can, despite the semi-tropical Hawaiian climate, enjoy the best of skiing atop Mt. Mauna Kea, 13,825 feet above sea level. This is the sixth highest mountain in the U. S. and its Territories.

★ ★ ★

And of course if you are frost-dodging, United Air Lines offers nine Hawaiian vacations ranging from a seven-day Waikiki Holiday to a 22-day, five-island tour. Cost of the seven-day tour for example is \$271, plus tax, and includes round-trip transportation from California and hotel accommodations.

★ ★ ★

The New York airports have inaugurated a system, operated by Mercury Service, which eliminates baggage handling for visitors to New York. When you arrive, you turn over your baggage claim ticket to a representative of Carey Transportation, official limousine service, and receive a receipt. The delivery of your bags follows to your hotel or home and is operated anywhere in New York City and within a 100 mile radius. Fees range from \$2.00, depending on the number of pieces and the delivery point.

★ ★ ★

Union Steamships, Limited, of Vancouver announces 10-day Alaskan Cruises this summer on the S.S. Chilcotin which carries 106 passengers. Reservations should be made as far in advance as possible. Tours start on June 7th and the last cruise is scheduled for September 3rd. Rates from \$255 to \$375. We have the folders for those interested.

For Elks Who Travel

(Continued from page 19)

by Richard Ellington, a mystery writer.

To get to St. John in the first place, visitors have to make their way to St. Thomas, which is a scant forty-minute airplane ride from San Juan, Puerto Rico. Compared to sleepy St. John, St. Thomas is a big town. The main street of town is lined with an assortment of shops and a scattering of night clubs. The shops offer watches from Switzerland, clocks from Germany, prints from India, fine chinaware from Denmark, glass from Sweden, stainless steel and silver also from Scandinavia, gloves from France, cashmere sweaters and jackets from Britain. All of this moves at free port prices, as does all sorts of liquor from around the world. Scotch whiskey at \$2.50 a bottle is a fair indication of what to expect.

As for specific places, the Elverhoj and Cavanagh's have what to my mind are the most interesting collections of women's wear. The Elverhoj's fashions have become popular in the Stateside fashion magazines and some of their creations are marketed

on the Continent. The Continental near the post office has good buys on everything except its watches, on which it offers no guarantees. Finally, A. H. Riise's Gift Shop is one of the most beautiful emporia on the island.

As for hotels, St. Thomas has a huge Miami-type establishment in the Virgin Isle Hotel, which sits on a hilltop grand and imposing. On the opposite side of the town is a smaller hotel known as Bluebeard's Castle, recently improved. Elsewhere there are any number of small guest houses, among them Smith's Fancy, Higgin's Cate, and others where the fee is less, the house count considerably smaller, and the atmosphere, sort of posh boarding house.

In point of development and quiet, the third island, St. Croix, is approximately midway between St. Thomas and St. John. It has an airport and is a stop on Pan American's run down the string of Lesser Antilles. It has an inn called the Hotel-on-the-Cay, perched on an offshore island, a

hustling little hotel in the Buccaneer, a branch of Connecticut's famous Stonehenge known here simply as The Henge.

Still to be discovered by the roving tourist army are the British Virgin Islands which are on no route at all. A boat leaves St. Thomas twice each week for the British island of Tortola, which has steep slopes and a very small hotel, where there is absolutely nothing to do but enjoy the view or go for a swim. There are excursions out to Virgin Gorda by sailboat, where there are pools in a grotto and some magnificent beaches. A pair of New Yorkers are leisurely building a hotel in Tortola during their winter vacations, but it is far from ready. On adjoining Beef Island a small development is starting with six rooms and a dining room already completed and grandiose plans are afoot for cottages spread through the nearby atolls, a supermarket in the middle of the sea, and who knows what-all. As things stand at the moment you really have to want to get away away from it all.

The Near East

(Continued from page 7)

ist movement for a national homeland had official approval, and it should be noted that the word "national" was included. The Zionists had reason to rejoice and they did so. More than that, they began moving persons into Palestine.

The Arab reaction, naturally, was hostile. In 1920 and 1921 there were serious Arab outbreaks against the Jews. These were sternly put down by the British, but within a few years, 1929-30, they flared again with increased strength. By late in 1938 the two communities were in a state of virtual warfare. Arab violence diminished early in 1939, with the publication of a British White Paper that repudiated the idea of an independent Jewish state in Palestine, but this was the signal for renewed Jewish attacks upon the Arabs. The strife continued until the outbreak of the war late in the year.

In the reports of a succession of "commissions" the British sought to clarify their mandate position and to meet some of the demands of each of the communities. These were not successful. First, they tried to explain that the Balfour Declaration really referred, not to a political, but to a "cultural" homeland for the Jews. This was indignantly repudiated by the Zionists, who pointed to Lord Balfour's use of the word "national". By this time, moreover, the Zionists had set up a strong administrative international arm in The Jewish Agency. Their position was no longer weak.

The Problem Extends

Then, because the real reason for Arab uneasiness was the increase in Jewish immigration, the British tried to carry out the doctrine of economic "absorptive capacity" as the yardstick for determining how many Jews could be admitted to Palestine. This also failed, for two reasons. The new Zionist colonies in Palestine were flourishing and they had an "absorptive capacity" that was beyond the worst fears of the Arabs. In addition, the rise of Hitler in Germany and his fearful persecution of the Jews made the Jews not merely economic but moral refugees. That a place of safety could be denied to them on a basis of some formula was an idea that was so shocking that Britain had to abandon it. By 1937 Britain gave up the idea of "absorptive capacity" and proposed an arbitrary limit of Jewish immigration for five years, after which further entry was to be subject to Arab consent. This, also, would have been morally intolerable without the accompanying recommendation for the permanent partition of Palestine into separate Arab and Jewish states. This was flatly rejected by the Arabs, accepted with some important qualifications by the Jews and eventually discarded by the League of Nations, to which the recommendation had been made. Violence continued.

With the outbreak of the war in 1939 there was a real truce between Jews and



More . . . and more . . . and more
ECHO SPRING answers the call
 for truly smooth
Kentucky Straight Bourbon

No finer bourbon ever came out of Kentucky. And yet Echo Spring comes to you at a price lower than most other Kentucky Bourbons. For a truly smooth bourbon call for Echo Spring again...and again...and again.

STRAIGHT BOURBON WHISKEY...86 PROOF...ECHO SPRING DISTILLING COMPANY, LOUISVILLE, KY.

WHY I WEAR AN ELKS PIN

by

Past Grand Exalted Ruler Robert S. Barrett

It is an emblem that tells the world that I am a member of a great Fraternity of a million American citizens who believe in God and in the destiny of the United States of America to bring happiness to its people and peace to the world.

It is an emblem whose antlers are symbolic of the elk in the freedom of the forest and indicates that I too am free, free to worship God according to the dictates of my conscience, free to vote as I choose, free to speak as I choose.

It is an emblem that tells that I believe in charity—the charity of kindly thoughts as well as of kindly deeds; a charity that feeds the hungry, heals the sick, straightens crippled limbs, opens blind eyes.

It is an emblem that declares my willingness to assist the youth of our land by education, guidance and protection in reaching the highest ideals.

It is an emblem that protects woman-kind and is an assurance that neither harm nor tears will ever be brought to any good woman through fault of mine.

It is an emblem that shows that I believe in brotherhood, that every man of every creed is my brother and that as I believe in the Fatherhood of God, so do I believe in the Brotherhood of Man.

The emblem of my Fraternity! The emblem of my faith! An emblem of my country! God grant that I may always be faithful to all it represents.



7-E Standard Elks Pin
 10k gold plated
 \$4.00

Read why a leading Elk is proud to wear his Elks pin and you will be proud to wear yours too.

Here's your officially approved Standard Elks Pin. It is beautifully enameled red, white, and blue.

Elks officially approved pins are offered at sensible prices in a variety of designations including standard membership (shown above), various years of membership and other designations. Send for illustrated folder giving prices and descriptions.

THE ELKS MAGAZINE

386 4th Avenue
 New York 16, N. Y.

A TIMELY WARNING FROM FRED L. BOHN

Dear Exalted Ruler:

Communism always has put major emphasis on the subversion of youth as a means to world conquest. The "World Federation of Democratic Youth" is the name of the Soviet front organization through which the Kremlin has intensified its efforts to capture young minds throughout the world in the post-war period. Recently, this misnamed outfit invited youth of all countries to attend the "Sixth Annual Festival of Youth and Students" in Moscow July 28 to August 11 of this year.

The editorial entitled "The Communist Trap", in the December issue of *The Elks Magazine*, and the article entitled "Freedom's Facts—How Communists Exploit World's Youth", on page 46 of the same issue, gave timely warning that this "festival" is just another propaganda device to exploit and subvert young and impressionable minds in order to push the world along the road to Red slavery. The communists hope to attract youth from every country—and especially the United States—to increase the propaganda value of the "festival". To this end, they have blandly billed it as "non-political" and larded their announcements with such phrases as "mutual respect and understanding", and "the spirit of friendship".

To help lure unsuspecting youth to Moscow, the communists offer to pay the expenses of any youngster who can't afford the trip to the slave capital of the world. This in itself is a sufficient tip-off to the real purpose behind the "festival".

The communist butchery of Budapest students that ignited the Hungarian revolt has done much to strip communism of any appeal to youth. Knowing this, the Reds will put heavy promotion behind the so-called "festival". The communist apparatus in this country—including those fellow travelers who cloak their treason behind various false labels—will do everything possible to recruit American boys and girls for the trip to Moscow.

We need have no fear of the reaction of our youth, if they know the facts. It is our duty to make sure that they have the facts, so that no youngster in this country is duped into participating unwittingly in this communist propaganda hoax. We must make sure that the parents and the youth in every community are informed of the true nature of this "festival" and on guard against the blandishments of communists and their fellow travelers. To insure this, I request the cooperation of you and your lodge in the following measures:

1. Inform your members, at meeting and through your bulletin, about the phony "youth festival" and ask them to warn their friends and neighbors.
2. Notify your school authorities, youth groups, civic organizations and the clergy to be alert to efforts to publicize the "festival" and to proselyte youngsters in the community.
3. Give the press full information about the "festival" and the steps you take to alert your community against it.

Here is a very practical way for us to fight the communist conspiracy and I do earnestly hope that you will cooperate with this program to the fullest.

Sincerely and fraternally,
FRED L. BOHN
Grand Exalted Ruler

ain's attempts to enforce limitations on immigration, and especially illegal immigration, simply added fuel to the fire. The Arabs, at this stage, were not involved in acts of violence, but the Arab states united, in 1945, in putting a boycott on Jewish-made goods in the hope of putting economic pressure upon the Jews in Palestine.

In 1946 there was a concerted British and American effort to solve some of the problems. A joint commission rejected the idea of partition, urged relaxed immigration and proposed a continuing trusteeship under the United Nations. This was not accepted. The London Conference of September, 1946, failed.

Britain made a final effort. In 1947 the "last" proposals were made: a long-range plan, a federal Jewish-Arab state and continued trusteeship. This was rejected by Jews and Arabs alike. On Feb. 18, Britain declared the views of the Jews and the Arabs to be "irreconcilable", termed the mandate "unworkable", announced her intention to withdraw from Palestine as soon as possible, and referred the whole problem to the United Nations. Another era had ended.

The UN Phase, and Now

The problems were not solved. The trouble, real trouble, was just starting. It is still with us.

A special session of the General Assembly was immediately called (April 2, 1947) and the case was also referred to the Security Council. A "special committee" was set up. After four months it presented a partition plan, but with an economic union, that was promptly denounced by the Arab League. This plan, however, was subsequently endorsed (the vote was 33-13) by the General Assembly. The Arab delegations from six states were so incensed that they staged one of those famous "walkouts". The Trusteeship Council, however, was instructed to set up a working group to put the plan into operation.

Actually, it wasn't so bad. It would have given the Arabs most of the south of Palestine and an important section in the east. Jerusalem was to be completely internationalized. The plan might have worked with sufficient confidence on both sides. It is interesting and significant that some of the Arab delegations in the United Nations are now insisting that any "settlement" must go back to the 1947 proposals.

The immediate effect, however, was inflammatory. Within two days the Arab attacks upon the Jews began. Within six weeks there was an armed invasion from Syria and fighting continued throughout February of 1948. The United Nations was informed, from both sides, that it could not enforce a partition by military force.

The Security Council adopted a resolution calling for a cease-fire and set up a "truce commission". The Arabs agreed to a cease-fire in Jerusalem itself, but else-

Arabs. Both Jewish and Arab formations fought with the British forces and did well. The external threat to both was clearly to be seen.

When the tide began to turn in favor of the Allies, however, disorder was renewed in Palestine. But this time there was a difference; the Arabs were neither the attackers nor the target. The attackers were irresponsible elements among the Jews

and the target was Britain. Throughout 1944 and 1945 there was a succession of terrorist outrages, led in part by the notorious "Stern Gang", and there were anti-British demonstrations and attacks by the "action" group of the Zionists, Irgun Zvai Leumi, and even by the more reputable defense force, Haganah.

Responsible Jewish officials condemned such acts but could not stop them. Brit-

where the truce was not effective and the Jewish forces continued to show increasing military strength.

Then came a decisive turning point. The British announced the end of the mandate as of May 15 and began to speed their withdrawal. The Jews responded with the proclamation of a Jewish state in Palestine, to be known as Israel, and set up a provisional government under the leadership of David Ben Gurion. A few hours before the final British withdrawal the United States recognized this government as the "de facto authority" in the "State of Israel". A year later this state was formally admitted to the United Nations.

The effect on the Arab world was explosive. On the very day that the mandate ended a concerted attack began. Egyptian planes bombed Tel Aviv. Syria and Lebanon attacked in the north. There were even some Iraqi troops involved. The Jordanian Arab Legion, British-led, stood firm in the east. (It was the only Arab fighting force that showed first class discipline under fire.

The rest of the year was taken up with a succession of temporary "cease-fires", promoted by the United Nations, and renewed outbreaks of hostilities. Count Folke Bernadotte, of Sweden, was sent to the scene as "mediator", and was assassinated by Jewish terrorists. He was succeeded by Ralph Bunche, of the United States, who gradually worked out an armistice formula.

In the first half of 1949 Israel signed truce agreements with Lebanon, Jordan and Syria. The later "armistice" agreement with respect to Egypt continued into force, but a real peace even to this day has not been made; far from it.

New Population Created

The political questions were scarcely approached, much less solved, and they were enormously complicated by the fact that the fighting had created an entirely new population group, the "Arab Refugees", who subsequently came to number more than 900,000. These persons (and their proliferating descendants) were Arabs who fled from Palestinian homes because of the fighting. Many were concentrated in the "Gaza Strip" on the Mediterranean. More went to Jordan. Some went to Syria. They still constitute one of the most complex and difficult economic and political problems in the whole situation.

A further, and highly significant factor, was the demonstration of the effectiveness of the Israeli fighting force. The Israelis were nominally—and potentially—outnumbered at least ten to one. But they didn't lose in the field. Because of superior organization, training and discipline, plus some arms smuggled in from Eastern Europe, they defeated the Arabs, again and again. This obviously increased Arab apprehension about the newly-risen state. Israel was not only viable, it was potentially strong. The Arabs were worried.

For four years sporadic border fighting



CANCER LIFE-LINE

Through films, pamphlets, posters, exhibits and lectures, our life-line of cancer education reaches men and women in business and industry.

They learn facts about cancer which could mean the difference between life and death. For additional information about a program in your plant call the American Cancer Society or write "Cancer" care of your local Post Office.

 AMERICAN CANCER SOCIETY

HOW \$6 STARTED ME ON THE ROAD TO \$10,000 A YEAR

By a Wall Street Journal Subscriber

"Not long ago I picked up The Wall Street Journal in a railroad club car. I was amazed. I expected dull reading. Instead I found some of the best articles I ever read.

"I sent \$6 for a trial subscription. For the first time in my life I understand why some men get ahead while others stay behind. The reports in The Journal come to me DAILY. I get quick warning of any new trend affecting my income. I get the facts in time to protect my interest or make a profit. The Journal started me on the road to \$10,000 a year."

This story is typical. The Journal is a wonderful aid to men making \$7,000 to \$20,000 a year. To assure speedy delivery to you anywhere in U. S., The Journal is printed daily in five cities—New York, Washington, Chicago, Dallas and San Francisco.

The Wall Street Journal has the largest staff of writers on business and finance. It costs \$20 a year, but in order to acquaint you with The Journal, we make this offer: You can get a Trial Subscription for 3 months for \$6. Just send this ad with check for \$6. Or tell us to bill you. Address: The Wall Street Journal, 44 Broad St., New York 4, N. Y. EM-2

DEALERS

Here's How You Can Help The Elks

One of the first questions we are asked by advertisers is

"How many dealers are Elks?"

The more Elks who are dealers in your line or any other, the better chance we have to interest advertisers who sell through dealers. And the more advertising your Elks Magazine sells the more it helps the Order through the Grand Lodge. So won't you, if you haven't already done so, take a moment or two to fill out and return the coupon below indicating whether you own, are part-owner or manager of a retail store? It will help your Order and your courtesy will be much appreciated.

THE ELKS MAGAZINE

386 Fourth Avenue, New York 16, N. Y.

MY NAME IS _____

ADDRESS _____

CITY _____ STATE _____

TYPE OF BUSINESS _____

(PLEASE CHECK BELOW)

I OWN THIS STORE

I AM PART OWNER OF THIS STORE

I DO NOT OWN, BUT MANAGE THE STORE

"Monitor" Runs Comprehensive Article on BPOE

Under the heading "Millions for Benevolence", a most comprehensive and enlightening article about the B.P.O.E. appeared in the November 23rd issue of "The Christian Science Monitor", occupying the lead page of the Second Section. The article was written by Max K. Gilstrap, Chief of the "Monitor's" Central News Bureau.

"More and more, the warm humanitarianism of the Benevolent and Protective Order of Elks of the U. S. A. is becoming recognized in its youth and old age programs that go beyond the social features of the organization", the sub-title of the article stated. Basically that was the theme of the "Monitor's" article, although there was considerable historical background about Elksdom included.

Mr. Gilstrap particularly drew attention to the work of the Elks National Foundation, the Elks National Service Commission, the Memorial Building in Chicago and the Elks National Home at Bedford.

The manner in which Mr. Gilstrap's article reflected the spirit of Elksdom was truly gratifying. "Membership in the Elks buys nothing but a card that will admit a member in good standing to any lodge," he wrote. "The Elks offer no insurance, or any other hope of financial gain, as an inducement to becoming a member. Even though founded for the purpose of aiding distressed members, the Order never has had a stated obligation to give relief.

"In pondering their manifold activities the Elks are glad to be judged in terms of the Biblical quotation, 'By their works ye shall know them.' Lending a hand to the unfortunate is their chief goal. Their reward is in the grateful thanks of those rehabilitated in hospitals, clinics, and summer camps; in young people encouraged with monetary assistance to get an education; and not the least in the gratitude of loyal members in need who live in peaceful and happy retirement as guests of the Order in the Elks' beautiful National Home in Bedford, Va.", the article concluded.

"Millions for Benevolence" attracted a

continued. First one side and then the other provoked it. Each blamed the other and its impartial "investigators" reporting to the United Nations were inclined to blame both. It was the situation that was at fault.

Tension was aggravated by Egypt's action in closing the Suez Canal to Israeli shipping and to cargoes bound for Israel. The Security Council condemned this action but did nothing concrete about it. A later condemnation was vetoed by the Soviet Union.

It was at this point that two new considerations intruded. The first was the rise of an irresponsible dictator in Egypt, Col. Gamal Abdel Nasser. The second was a shift in the policy of the Soviet Union, away from Israel, and in support of the

THE CHRISTIAN SCIENCE MONITOR

Friday, November 23, 1956

More and more, the warm humanitarianism of the Benevolent and Protective Order of Elks of the U.S.A. is becoming recognized in its youth and old-age programs that go beyond the social features of the organization.





Veterans Enjoy Entertainment Provided by Elks at Lisle, Colo.

Millions for Benevolence

By Max K. Gilstrap
Chief of the Central News Bureau of The Christian Science Monitor

LITTLE MORE than a year ago, the Benevolent and Protective Order of Elks of the U.S.A. was a relatively obscure fraternal organization. Today it is a national force, its humanitarianism and social programs being widely recognized and appreciated.

The Elks National Foundation, the Elks National Service Commission, the Memorial Building in Chicago and the Elks National Home at Bedford, Va., are the result of the Elks' long and successful program of benevolence.

The Elks' National Home at Bedford, Va., is a beautiful and comfortable place for the aged and infirm. It is a place where the Elks have spent millions of dollars to provide a home for their members in their old age.

The Elks' National Home at Bedford, Va., is a beautiful and comfortable place for the aged and infirm. It is a place where the Elks have spent millions of dollars to provide a home for their members in their old age.



Elks National Home at Bedford, Va., for Old-age Guests

The Elks' National Home at Bedford, Va., is a beautiful and comfortable place for the aged and infirm. It is a place where the Elks have spent millions of dollars to provide a home for their members in their old age.

The Elks' National Home at Bedford, Va., is a beautiful and comfortable place for the aged and infirm. It is a place where the Elks have spent millions of dollars to provide a home for their members in their old age.



President Eisenhower Presents Awards to Winners of Elks National Youth Leadership Contest

Support Needed

The Elks' National Home at Bedford, Va., is a beautiful and comfortable place for the aged and infirm. It is a place where the Elks have spent millions of dollars to provide a home for their members in their old age.

Restrictions Dropped

The Elks' National Home at Bedford, Va., is a beautiful and comfortable place for the aged and infirm. It is a place where the Elks have spent millions of dollars to provide a home for their members in their old age.



The Elks' National Home at Bedford, Va., is a beautiful and comfortable place for the aged and infirm. It is a place where the Elks have spent millions of dollars to provide a home for their members in their old age.

great deal of attention, and after hearing about it, a considerable number of members of the Order wrote to the "Monitor" to obtain a copy. "The Christian Science Monitor" is recognized as one of the

most distinguished newspapers in the country and this ably and understandingly written article was most sincerely appreciated by every member of the Order who had the good fortune to read it.

Arab League. Colonel Nasser took advantage of this shift and obtained arms from the Soviet satellites to fight the Israelis. With the confidence that he had the means at his disposal, several times he proclaimed over the Cairo radio of his objective of "driving the Israelis into the Mediterranean", and setting up an Arab empire from Gibraltar to the Arabian Sea.

Border incidents had multiplied rather than diminished. The United Nations found that the Arabs had been the provocateurs in this border warfare in a ratio of about three to one of the incidents. The Israelis, however, were by no means impotent. They retaliated, in each case, strongly, and initiated some cases on their own. It was not one-sided.

After Colonel Nasser struck at the Suez Canal, in 1956, the Israelis went into action. On the basis of ending "commando raids" from Egyptian held positions in the Sinai Desert and the Gaza Strip, they launched a full scale invasion and quickly drove the Egyptians back. The Soviet-supplied arms were not good enough to help the Egyptians.

Again the United Nations was called in. Britain and France, which had intervened with force in the Canal Zone, for the purpose of protection, as they stated, were called upon to withdraw. Israel, which had invaded the Sinai Desert area and driven Egypt almost to the Canal, was ordered to retire. A United Nations force was quickly organized and dispatched to the Zone to "assure compliance" and "maintain or-

der". Britain and France withdrew. Israel pulled back. The problem went back to the United Nations.

The surface had only been scratched. The big questions were not answered. The headache remained. The problem is unsolved.

* * *

These are the cold historical facts. Now, what are the warm human feelings that lie behind them? History is made up of ideas as well as of dates. What complicates this situation? Why can't we get a workable solution? Here, again, there are three major factors: the rise of a Jewish state; the emergence of Arab nationalism; the great impact of West upon East. Let's look at them.

Rise of a Jewish State

Zionism was originally a religious concept. After the Balfour Declaration it became a political concept. In the 1930's it became a practical concept. It was possible to create a physical and political "homeland" for the Jews.

The immigration figures tell their own story. In less than fifteen years (1922-1936) the Jews came up from less than 13 per cent of the population to more than 30 per cent. At the time of the Balfour Declaration there were not as many as 100,000 Jews in Palestine. Today there are more than a million. They have come from all over the world but, because of Hitler's persecution and subsequent Soviet pressure, most of them were European in origin. This has lately been changed and at the present time a slight majority of the Jewish population in Israel is of non-European origin.

These immigrants were no ordinary "refugees". They brought a concentration of skills into the development of a new country that has rarely been seen in history. Their ability, and their devotion, assured from the start that the project would not fail.

It is well to remember, however, that they had massive outside assistance. This is the sorest spot with the Arabs. It is impossible to escape the figures and they have been trumpeted throughout the Arab world.

From 1947 to the end of 1955 the Israelis had received at least \$2,000,000,000 in external assistance. Direct United States Government aid accounted for only \$367,000,000, and this compared not too unfavorably with the \$163,000,000 that had been granted to the Arab states. But this was only a start. There was an Export-Import Bank loan (\$135,000,000); there were bond sales in the United States (\$227,000,000); there was United Jewish Appeal (\$360,000,000); there was West German reparation (\$160,000,000); and on top of all these were gifts and investments from foreign sources that reached a total of \$886,000,000. There were no such gifts for the Arabs.

They were not merely chagrined. They were alarmed. And they had a right to be. There was still more to fear. Early in

its existence this new nation of Israel had unanimously adopted and proclaimed the "Law of the Return." This granted and affirmed the right of every Jew, anywhere in the world, to immigrate to Israel. In one year, 1949, almost a quarter of a million came in. In Arab eyes this was a tidal wave.

More than that, this Jewish community, in contrast to its Arab neighbors, was beginning to prosper. Those skills were paying dividends. As early as 1946, when the Jews were less than a third of the population they were paying two-thirds of the taxes. They bought land from the Arabs and used it well. They were spreading.

This very success had a two-fold effect. It increased, enormously, the self-confidence of the Jews. They were no longer under-dogs. One sympathetic observer in the United Nations even called them "cocky". On the other hand, it multiplied the determination of the Arabs to be rid of this intruding state, by one means or another. The rise of Israel was dramatic, and historic, but it didn't solve the problems.

Rise of Arab Nationalism

As has been noted, the first stirrings of Arab nationalism were anti-Turkish in origin. This was not a "popular" movement, in our sense of the word, but an upper-class movement. Unfortunately, this is still largely the case. The targets have shifted from time to time. The return of

Turkish rule was always a menace, but in Egypt it was Britain that was the opponent; in Syria and Lebanon it was France. Now it is Israel. At no time, however, was nationalism the product of a drive for good government as well as self-government. Its rise is still essentially a political, not a social, upheaval.

It obtained international stature by the formation of the Arab League at the end of the war. Its Charter was signed on March 22, 1945, and the signatories were Egypt, Iraq, Syria, Lebanon, Saudi Arabia and Transjordan (now Jordan). Every one of these, it will be observed, had become newly independent, although Egypt, leader of the group, had actually come further than the others. Yemen, a later member, and Jordan were not regarded as sufficiently self-governing to be represented at the formation of the United Nations. Both were subsequently recognized as independent and admitted.

It is important to note, at this point, that this was an "Arab" League and not a "Moslem" league. Its foundation is not religious, although occasionally some irresponsible Arabs have tried to make it so. The two most important Moslem states, Turkey and Pakistan, want no part of the Arab League. Iran, with a majority Moslem population, is not a member. Iraq has been a thorn in the side of the Arabs because of its alliance with the West in the Baghdad Pact.

This is vital because the contest between

WATCH THAT BALL... OR I'LL TAKE YOU PAL! !

IT'S WORTH THE LOSS IF I WIN THAT GAL!

**SMELLS GRAND!
PACKS RIGHT!
SMOKES SWEET!
CAN'T BITE!**

YOU'RE A PIPE SMOKING MAN? THEN YOU'RE FOR ME!

IT'S SIR WALTER RALEIGH... NATURALLY!

SIR WALTER RALEIGH'S BLEND OF CHOICE KENTUCKY BURLEYS IS EXTRA-AGED TO GUARD AGAINST TONGUE BITE.

FREE!

24-PAGE BOOKLET ON PIPE CARE. JUST WRITE TO: SIR WALTER RALEIGH, DEPT. 195-A LOUISVILLE, KY.

WILL YOU SMOKE MY NEW KIND OF PIPE 30 DAYS AT MY RISK?



All I want is your name—so I can tell you why I'll send you my pipe without a cent of risk on your part

I've been a pipe smoker for 30 years—always looking for the ideal pipe—buying all the disappointing gadgets—never finding a single, solitary pipe that would smoke hour after hour, day after day, without bitterness, bite, or sludge.

With considerable doubt, I decided to work out something for myself. After months of experimenting and scores of disappointments, suddenly, almost by accident, I discovered how to harness four great natural laws to give me everything I wanted in a pipe. It didn't require any "breaking in". From the first puff it smoked cool—it smoked mild. It smoked right down to the last bit of tobacco without bite. It never has to be "rested". AND it never has to be cleaned! Yet it is utterly impossible for goo or sludge to reach your tongue, because my invention dissipates the goo as it forms!

You might expect all this to require a complicated mechanical gadget, but when you see it, the most surprising thing will be that I've done all this in a pipe that looks like any of the finest conventional pipes. The claims I could make for this new pipe in tobacco enjoyment are so spectacular that no pipe smoker would believe them. So, since "seeing is believing", I also say "Smoking is convincing" and I want to send you one Carey pipe to smoke 30 days at my risk. At the end of that time, if you're willing to give up your Carey Pipe, simply break it to bits—and return it to me—the trial has cost you nothing. Please send me your name today. Just a postal card will do. I'll send you absolutely free my complete trial offer so you can decide for yourself whether or not my friends are right when they say the Carey Pipe is the greatest smoking invention ever patented. Send your name today. As one pipe smoker to another, I'll guarantee you the surprise of your life, free. Write today! E. A. Carey, 1920 Sunnyside Ave., Dept. 10-B, Chicago 40, Illinois

STRATHMORE'S FINE RAG PAPERS For Writing or Typewriter

100 8 1/2 x 11 Letterheads	\$4.00
100 No. 10 Envelopes	4.00
100 5 1/2 x 8 1/2 Noteheads	3.50
100 No. 6 3/4 Envelopes	3.50
100 Informals and envelopes	5.00
100 Business Cards	3.50

Prices include 3 or 4 lines of printing, prepaid postage and insurance.

ROBERT M. OLIVA

29 Mead Avenue Cos Cob, Connecticut

"ROLL" WALL CLEANER

New MIRACLE

DRY roll wall cleaner. No mess. No fuss. Simply glide over walls. Removes dirt like magic from Wallpaper, Painted Walls, Ceiling, Window Shades. Leaves beautiful lustrous finish. Take orders. Earn money!

SAMPLES FOR TRIAL

Sample offer sent at once to all who send name. Hereafter just a postcard will do. **SEND NO MONEY!** Just your name.

KRISTEE CO., Dept. 561, Akron 8, Ohio

HUNDREDS OF IDEAS for BRONZE PLAQUES

FREE illustrated brochure shows hundreds of original ideas for reasonably priced solid bronze plaques—name plates, awards, testimonials, honor rolls, memorials, markers.

Write For FREE BROCHURE A For trophy, medal, cup ideas ask for Brochure B.

INTERNATIONAL BRONZE TABLET CO., INC.

Dept. 40—150 West 22 St., New York 11

ELKS ROAD SIGNS

Welcome visiting Elks to your Lodge by erecting these signs on main highways into your city.

30" Emblem sign in five colors, vitreous porcelain enamel on steel.

10" x 24" por. enam. plate with 3 lines of lettering available in 2 colors.

\$29.75 F.O.B. Chicago

Allow 3 weeks for shipment (We do not supply post)

RUSSELL-HAMPTON CO.

303 W. MONROE ST. CHICAGO 6, ILL.

Arabs and Jews is not essentially religious. It is political and economic. The attempts to preach "holy war" by some Arab firebrands have been rightly and generally denounced in many parts of the Moslem world.

Arab nationalism, and nationalist self-consciousness, are, however, becoming more important every day. When Colonel Nasser declaims about a great "Arab Empire" he strikes responsive chords. At the moment, the largest single obstacle to such a conquest is not the remnant of a Western "colonialism"—although that is always a convenient whipping-boy—but the rise of a new non-Arab, and basically Western state, Israel, on what has always been held by the Arabs to be their own land. Arab nationalism thus has a fresh, and formidable, foe.

West Against East

Here we come to the very heart of the conflict. In spite of the recent slight shift in population majority, Israel is essentially "Western." Its leaders, and some of its best pioneers, have deep roots in European—and American—culture. The techniques of development are those of the West, not the East. And the money that has made the application of those techniques possible is Western money. Without that support it is at least questionable if this community could survive. It would not flourish.

In spite of the influx of Western capital and skill in developing the oil resources of the Middle East most of those methods and techniques that are already a commonplace in Israel are alien to the Arab world. This is a new impact, on the "down-to-the-desert" level.

Standards of living, social organization, community responsibility, are far below decent human standards in every one of the Arab states. Those things are being changed for the better in Israel, but the change has come too rapidly to contribute to the Arab peace of mind. It is not merely a political order that has been shaken; it is a social order. To put it simply, the Twentieth Century has moved in on the Fourteenth.

This is not to say that there are not many of the Arab leaders who desire the

greatest possible advancement for their countries. It is not just "progress" against "reaction". But it is a difference in timing and it is a conflict in philosophy as well as force.

What Can Be Done?

The long-range problem will not be solved easily. The person who has a pat answer is a propagandist. There are, however, some immediate things that can and must be done.

First, the United Nations must assume the responsibility for establishing and effectively patrolling any boundaries that can be set. The "incidents" must come to an end, since they cannot make any possible contribution to a final solution.

Second, the United Nations and its members must take far more sweeping and effective steps to provide for the resettlement of the "refugees". They constitute a continuous emotional overtone that can drown out the voice of reason. Not merely on humanitarian, but on practical, grounds this problem must be met squarely and solved.

Third, there must be a concerted effort, in the United Nations and elsewhere, to promote the regional development of the entire area. This was the reason for the basic plan of the Jordan River development that would have helped Syria and Lebanon as well as Jordan and Israel. This plan was opposed in part by Syria and blocked in the United Nations by the Soviet Union, but it should not be abandoned. More than that, other and more ambitious plans should be added.

Those same skills that have made the growth of Israel possible should be applied, also, to making the life of the Arabs more fruitful. In this way Israel can become the friend and helper, not the menace.

Finally, it should be obvious that the United Nations, and the United States, will be obliged to tell the Soviet Union to keep its hands off this area. Its purpose is strife; our purpose is peace.

This is the basic problem. Its solution will require patience, skill and imagination. It will also require firmness of resolution. The free world need not be deficient in those qualities.

Lodge Visits of Fred L. Bohn

(Continued from page 9)

ters of the Babe Ruth Baseball League, where he met Joseph W. Cookson, Administrative Secretary, and Clifford S. Conner, Member, Board of Directors, who explained to him the purpose of the organization and its success throughout the country.

The Grand Exalted Ruler's escort then took him to the Capitol of the State of New Jersey, where he was presented to Governor Robert B. Meyner, a member of the Phillipsburg Lodge, and also to Edward Patton, the Secretary of State, a member of Perth Amboy Lodge. Following a sociable half hour with the Gover-

nor and the Secretary of State, the Grand Exalted Ruler was taken to a suite at a local hotel, where he prepared for dinner. At 6:15 p.m. a State Police escort took

Grand Exalted Ruler's Itinerary

- Jan. 17-18 Washington State Elks Association's mid-winter meeting at Vancouver
- Jan. 19 Ontario, Oreg., Oregon Association's mid-winter meeting
- Jan. 20 Moscow, Idaho, mid-winter meeting Idaho Elks Association

Mr. Bohn to Hightstown, New Jersey, Lodge for a banquet. Following the banquet, the Grand Exalted Ruler, together with a staff of Grand Lodge Officers, dedicated Hightstown Lodge's new home. The dinner and dedication was attended by approximately 350. After the banquet Past Grand Exalted Ruler William J. Jernick drove Brother Bohn to his home for the close of a most eventful day.

On November 15th, accompanied by Past Grand Exalted Ruler William J. Jernick, State President Hubner, District Deputy Richard Tobin and Vice President Daniel V. Crosta, the Grand Exalted Ruler continued his New Jersey visitations by making an official visit to the Passaic County Cerebral Palsy Center. After a

Leather Lullaby

(Continued from page 13)

and Neanderthal jaw and remembered that Sailor Morris, from whom Danny won the championship, had had a head and face and jaw like that and it had broken that fine, murdering right hand of Danny's.

"I'll slug with him," Danny told himself. He looked down at his right glove and flexed the long, blunt-tipped musician's fingers inside of it. "I can outbox this monkey, too. I've just been careless is all. I won't let him get at me again. They call it boxing, don't they? This is a boxing match?"

So Danny sprawled on his stool and sucked in lungful of smoky air and listened to Jingo Jones saying: "You got to do it for me, Baby! I got everything I own on you, this fight. You know that. I did it because this meatball is made to order for you if you slug it out with him. The way you can counter. But you can't outpoint him. He's proved that. You got to—"

The warning buzzer cut Jingo off and he and Danny's handlers scrambled out of the ring. "Don't worry," Danny told him. "Everything's under control." He meant that. He felt better now. He'd go out there and make a chump out of this McKoy. Just for Jingo. It would be pie. It would be a pleasure to show them all he didn't have to be a barroom brawler and go busting his hands on this cinder-block-head they were feeding him.

Buster McKoy didn't feel that way about it. The Buster came at him carelessly wide open, grinning, showing part of his mouthpiece, inviting Danny to hit him. Danny took the invitation and flicked out a stinging left. Buster brushed it off like a cow switching its tail at a fly. Buster kept coming in at him, crowding, that left not bothering him because there was nothing much to Danny's left. It was just a garden variety left hand punch with little poison in it. It had always been used just to set up a situation for Danny's right. For that reason other fighters had always kept away from it—but not Buster McKoy.

Danny got on his velocipede backward

brief visit and inspection of the building, luncheon was served at which officers of Passaic, Paterson, Clifton and Pompton Lakes were present. The Grand Exalted Ruler was most enthusiastic in his compliment of the work being performed at this clinic, which is entirely sponsored by the Elks.

The next visit was to New Jersey's Boystown at Kearny. The building at New Jersey's Boystown had been renovated and refurbished by some 21 Elks Lodges. That evening a dinner was tendered to the Grand Exalted Ruler by the lodges in the northern part of New Jersey. The dinner was held at Mr. Jernick's home lodge, Nutley, and was attended by about 350 members.

and began to peddle away, and Buster loved that. He kept stalking Danny, getting ever closer. A ring is not a large place. You can't stay away from a man forever. Especially using one hand. After awhile Buster caught him. He cannonballed a left and a right and another left. Danny took the first two on his elbow and shoulder. He took the third one on his nose and he felt it spread like an omelette across his face. Danny's eyes filled and his throat and his mouth held the salty taste of blood. Danny got mad. He had liked that nose. It was the only one he had. It was a nice nose. Emily had told him so. It wasn't nice any more, he could tell.

Danny charged like a red-flagged bull, a snarling noise coming from his chest. He caught Buster with a left hook to the middle and feinted and then lanced a left jab to the face, staggering Buster, getting him on his heels, setting him up. Then he cut out with the right, the Danny Shane right, the one Jingo called "the candle punch"—one blow and you're out like a light. It made a whistling noise but Danny was crazy and his timing was off. It had been so long since he'd tossed that right. It just skinned across the side of Buster's skull, taking some hair and some scalp with it.

The crowd came up from their seats and their cry was one thunder-rumble of sound. This was what they wanted. This was what they'd paid to see. But then the noise faded because Danny Shane didn't follow through. The anger let out of him and he pulled that right back as thought it had been burned. He didn't un-cork it again.

Some of the color came back to Buster McKoy's face. Some of the horror went out of his eyes. He lost his momentary hesitancy. He went to grinning again and moving in. He watched Danny smear blood from his nose and his mouth and try to circle away. Buster came in with a rush and tied Danny's arms. Buster's head came up under Danny's chin and this time the choir in Danny's ears had organ accompaniment. It was like in a

Law!

STUDY AT HOME

We guide you step by step—furnish all text material, including 14-volume Law Library. Training prepared by leading law professors and given by members of the bar. Degree of LL.B. Low cost, easy terms. Send for valuable Free Book, "Law Training for Leadership," today.

LaSalle Extension University, Dept. 2328L
A Correspondence Institution Chicago 5, Ill.

Big Mail Order Profits

FREE BOOK from IMPORTS



Men, women, coast to coast making money now on small imports with plan based on our 30 yrs. experience. We show you how to import at bargain prices for friends, stores and MAIL ORDER, also how to get free mail order ads. We give you names of foreign suppliers who ship direct, so no stocks to carry. Write for FREE BOOK. Air mail reaches us overnight. Mellinger Co., Import-Export, Dept. G392, 1717 Westwood, Los Angeles 24, Calif.

BOOK MANUSCRIPTS CONSIDERED

by cooperative publisher who offers authors early publication, higher royalty, national distribution, and beautifully designed books. All subjects welcomed. Write, or send your manuscript directly.

GREENWICH BOOK PUBLISHERS
Attn. Mr. Essex 489 Fifth Avenue
New York 17, N. Y.



Life Member

#9—\$9.15. One of the many officially approved Elks pins. Write for illustrated

folder to The Elks Magazine, 386 Fourth Avenue, NYC.

not everyone does as well, but E. O. Lockin, who started a business of his own, reports...

for 12 months I've averaged
\$800 PER MONTH
INCOME—
most of it clear profit for me!

Many men have discovered how to be independent, to be free of bosses and layoffs. L. A. Eagles grossed more than \$200 his first week. Others report gross up to \$12,000 per year. How much you make depends largely on you. You need no special skill, no large investment.

No shop necessary. OUR ELECTRIC RUG WASHER cleans rugs, carpets right on floor... helps to show their natural color and beauty. So efficient and safe, used by largest hotels and railroads.

You take no risk. Machines fully guaranteed.

Write for full information including how to make big profits in YOUR OWN business.

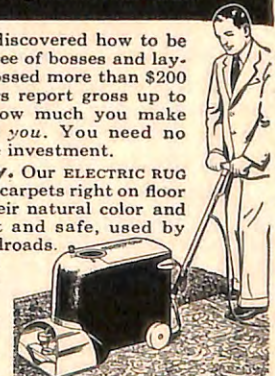

MAIL COUPON TODAY FOR FREE BOOK

VON SCHRADER MFG. CO., 224 "R" PL., RACINE, WIS.
Without obligation, send your FREE booklet containing information about your ELECTRIC RUG WASHER and how I can start my own permanent, profitable business.

Name _____
Address _____
City _____ Zone _____ State _____

Elk Leader in Philippines Passes Away



On November 6, 1956, Thomas J. Wolff, designated in the leading newspaper of Manila as an "American Old Timer and former civic and business figure", died at the University of Santo Tomas Hospital in that city, at the age of 76.

For many years he had carried on a brave and running fight with cancer, being operated on eight times.

Tom Wolff had led an adventurous and

very successful life. Leaving his home in an eastern state while still in his teens, he had thrilling experiences at sea and in South America where he participated in some of the turbulent affairs that from time to time occur there.

In 1898 he reached Manila with the United States Army and remained there to become a leader in the business, civic and fraternal life of the community.

He was generally known as the "Father of the Elks" in the Philippines. He was Exalted Ruler of Manila Lodge and twice served as District Deputy for the District of the Philippines and Guam.

He was the founder of T. J. Wolff and Company, a radio import corporation, and had extensive mining interests. He founded the first steam laundry in the Philippines. Among the many business activities in which he engaged and which he operated successfully were copra and coconut oil businesses and he was also a partner in a Philippine embroidery concern.

For many years he was Chairman of the Executive Committee of the American Red Cross in the Philippines. When his wife and he were interned for two years by the Japanese, his experience as a representative of the Red Cross and his qualities of leadership gave him an oppor-

tunity of securing many conveniences and comforts for the unfortunate internees of the Japanese occupation of the Philippines that otherwise would not have been obtained.

When the victorious forces of General Douglas MacArthur returned to the Philippines and freed the capital early in 1945, the Order of Elks appropriated \$100,000 from its War Funds to provide food, clothing, medicine and financial assistance to the hapless victims of the Japanese occupation.

Investigation determined that Tom Wolff was the best man to head a Relief Committee in Manila and funds were placed at his disposal. He was well equipped by experience and knowledge to carry out this assignment and he performed valiant work under difficult conditions.

Later, when money was advanced by the Grand Lodge to assist in the rebuilding of the home of Manila Lodge, it was Brother Wolff who was selected to handle the funds and again his loyalty, his fidelity to the Order and his business experience and good judgment assured the success of this undertaking.

Brother Wolff is survived by his charming wife, Caroline Crawford Wolff, who, through all the years of his successes and his trials, was his constant companion and who had for the many years of their marriage been the great inspiration and comfort of his life.

sad movie and Danny enjoyed it. Then Buster stepped on Danny's toes and stopped his retreat. He sunk a piston-drive right into the pit of Danny's brisket with all the power in his bull-shouldered body. The music left Danny's ears and there was just a headache and an illness of the stomach.

Danny remembered again the thing that had happened to his nose, and all the indignities suffered this night at the clubbing hands of Buster McKoy piled up inside of him. He thought about all of Jingo Jones's money riding on this fight. He felt terrible frustration because Buster refused to play it right, play it his way, and let Danny outpoint him and thus save his right hand, like with the other two boys who'd tried to take the title this year. Danny got mad again. But not all-out. He didn't go crazy like the last time.

Buster was a little careless now. He was overconfident. He thought Danny was farther gone than he was. He allowed Danny to drop his left to the floor and bring it up in a terrible gas-house-gang swing. Buster managed to get his jaw out of the way in time, and that saved him. It didn't save Danny. The haymaker landed above Buster's ear and there was no harder part of his cranium. Danny felt a tongue of lightning pain lick up his left arm to the shoulder. He let out a cry, but it was drowned in the crowd roar and Buster's oaths.

But Buster wasn't angry. He was curs-

ing with glee. He was shaking his head, approvingly, saying: "That's right, lover, hit me! Hit me again! You've got nice soft hands with milk in the bones, so they break easy. Especially that right. So come on and hit me again, Sonny, I love it. Bust both those pretty paws and we'll have one less piano player in the world. That's fine with me."

A look of horror mixed with the pain in Danny's face. Buster *did* know. He or someone in his camp had wised up from the pictures of Danny's last couple of fights. They figured for a fact that he wouldn't dare unleash that right hand.

Danny covered up and back-pedaled away, Buster coming relentlessly after him, his grin like a gargoyle's mask. Danny could hardly hold up his left hand. That one was gone now, too. He knew it. Through the pain impulses needling his brain he remembered after the Sailor Morris fight when the doc had set the bones in his right hand. "It may be all right," the doc said. "But it's a bad break." He remembered when they took the cast off and the doc had said, "It's better than ever. But don't hit any brick walls with it. Another break in the same place and you won't even thump another piano keyboard, Danny." The doc had said it laughingly, but Danny went green.

He never told anybody, not Emily, not Jingo, even, to whom he owed so much, but that was when Danny Shane became a ballet boxer. He knew he was clever and fast in the feet and he'd gotten away with

it for two fights because the boys didn't know that he was afraid to use the right. He'd thought he could get away with it forever. Why give up fighting and all that fine coin when you could dance your way through bouts?

But now there was Buster McKoy who had seen how things were, from the beginning. Even if he hadn't, it might not have worked, because as Jingo said, the Buster ate dancing masters. And now there was a broken left hand plus the right he was afraid to use, and one from one left nothing. He had nothing to work with against Buster. It would not be long now.

Danny gnawed on his mouthpiece and tried not to move his left hand. He got some quicksilver into his feet for a few moments and stayed away from Buster. In a temporary lull in the crowd noise, then, he heard Jingo Jones yelling to the officials: "Stop it, I tell you! The kid's hurt his hand. He's busted a paw again, I can tell. Stop the fight."

Buster and Danny looked at the ref and he came toward them. And Danny looked at Jingo Jones, gratefully, and saw the little guy's ugly, pug-nosed face twisted and creased into a delta map of emotion and a couple of tears bumping over it. Jingo was willing to give up everything, the fortune he'd bet, the title championship, because his boy, Danny, was hurt, might ruin his hand forever. That was Jingo Jones.

Jingo who had taken a big, dopey kid

out of a crumbjoint like the "Blue Flame" and built him slowly, surely, with loving care and lots of money spent, into a man with a name and a fortune. Jingo, who had paid for Danny's piano lessons, too, all the while he was learning to fight. And when Danny spent all his off hours practising, Jingo never once laughed at the pug who wanted to make like Duchin. How many fight managers, how many friends, do you find like that?

He'd told Danny: "It's a good thing kid. You can't fight forever. This way, whenever you're ready to pack it in, you'll be as good as the Eighty-Eight as you are at fighting. With your name, you can go into the bigtime band business with your own outfit."

All this Jingo had done for him. And now Danny was all ready and willing to let the little guy make this last, big sacrifice for him. He told himself there was nothing doing. It was time to stop taking from Jingo and give a little. He would go on with this if it killed him. What was a hand compared to a guy like Jingo Jones?

Danny shook his head savagely at the ref and the other officials. He half cried it out: "I'm all right! Don't pay any attention to him. He's crazy. My hand's all right, I tell you!"

He figured the left hand was gone now, anyhow. That couldn't get much worse. He could still try to outbox the Buster and with a few lucky leprechauns perched on his shoulder, maybe pile up enough points to cop the decision the rest of the rounds.

He settled back once more to meet Buster McKoy. He danced away for a few seconds, fending off Buster's savage attack with his gloves and elbows and shoulders, twisting, rolling with the punches. Then one of Buster's blows bounced off his bad left hand and he instinctively winced with the pain, eased it away. That was it. Buster came in all over him.

Danny remembered when he was a kid, once, and an enemy gang had caught him coming home from school alone in the winter. There had been a dozen of them and they had about a hundred snowballs each, all iced and ready. They got him cornered and it rained snowballs and they hit him from everywhere and he couldn't get away from them. It was like that now. Only the snowballs were immense and brown and soggy. He held up his hands against Buster's avalanche attack as long as he could, then they dropped. Buster caught him flush on the hinge of the jaw. Danny took off into blackness. . . .

IT WAS a long tunnel and dark as midnight. It kept spiraling and Danny was running along it, through the blackness, staggering against the way it spun, and then all of a sudden he would come out of it into blinding light and hit a great white wall of canvas and bounce right back into the dark, spiraling tunnel. He kept doing that.

Finally Danny got smart. He stopped running. This time when he came out into the bright light and up against the white canvas, he went up to it slowly and pushed at it firmly with his hands and it sort of moved back away from him, so he kept on pushing. That was how Danny Shane got to his knees. He heard someone saying: "—seven—eight—"

Danny mumbled: "Eight? Eight what?"

Then the voice said: "—nine—" and Danny got it. He'd been knocked down. He'd caught a wallop on the whiskers. Some other places, too, the way his nose felt and his insides. Well, that was what he was getting paid for. He suddenly realized that the count had stopped. He was on his feet and there was the ref wiping resin from his gloves and there was the ring and the lights and some bohunk in purple trunks in a neutral corner, all going around in a pretty little kaleidoscopic pattern. There was a great rumbling like a waterfall in a cave and that was the crowd.

Danny got into a crouch and flicked out his left, shaking his head, trying to clear it. He wasn't hurt badly, he knew. Just a little ache here, a little pain there and a fuzziness in the skull. He wondered why the other guy didn't come on and get it. He wondered vaguely who the bum was and what round it was and how long before this would be all over and he could go to a club somewhere and play some piano for him and Emily.

Somebody was coming toward him and Danny saw the purple trunks and the blur above them. He lashed out with the left and felt something hit him in the face at the same time, but he didn't pay any attention. His left snaked out again. He could tell by the give when it landed that this was the moment and instinct took over. He threw the right. It jarred his whole body. He waited but the blurred thing was still there, clawing at him, trying to hold onto him.

He shook it off, backed away and made with the left and the right again. This time the blur disappeared from his range of vision. The waterfall sounded swell so that it hurt his ears. Someone came over and lifted up his arm. There were a lot of people all around him and flash bulbs were popping. Someone stuck a mike before his face. He mumbled some kind of answers to the frenzied questions and then he was in the dressing room.

The fuzziness faded. Danny looked down and felt a great and stabbing pain. Someone said: "Easy, Danny!" It was a doc and he was cutting off one of Danny's gloves and the bandages on his hands. The pain got very bad and Danny made some garbled sounds and remembered it all, about Buster McKoy and Buster's head, the hand he'd broken against it and hitting that same head with his right after that—twice, at least.

He managed to open his eyes and look down as they took off the other glove, the right one. He saw that there was no

Become an ACCOUNTANT-

Auditor—C. P. A.

The demand for skilled accountants—men who really know their business—is increasing. National and state legislation is requiring of business much more in the way of Auditing, Cost Accounting, Business Law, and Income Tax Procedure. Men who prove their qualifications in this important field are promoted to responsible executive positions.

SEND FOR FREE BOOK

Knowledge of bookkeeping unnecessary. We train you from ground up, or according to your individual needs. Low cost; easy terms.

Send name and address on the lines below for free illustrated book describing the LaSalle Accounting training and the opportunities in this highly profitable field.

LASALLE EXTENSION UNIVERSITY
A Correspondence Institution
417 S. Dearborn St., Dept. 2328H, Chicago 5, Ill.

Name.....
Address.....
City.....Zone.....State.....



Everlasting Bronze BOOK OF MEMORY

For listing 100 to 3000 names economically. Write for free catalog including photos of hand-chased cast bronze plaques.

NEWMAN BROTHERS, Inc.
Dept. 722, Cincinnati 3, Ohio

QUICKLY FOLD OR UNFOLD FOR CHANGING ROOM USES



MAXIMUM SEATING MINIMUM STORAGE

TOPS OF MASONITE
PRESWOOD • FIR & BIRCH PLYWOOD • LINOLEUM • PLASTICS
STRONG, RIGID TUBULAR STEEL LEGS

Send for folder with complete specifications.
MITCHELL MANUFACTURING CO.
2748 S. 34th St., Milwaukee 46, Wis., Dept. G

LOW COST Fire Safety

SECURITY Fire Extinguisher

- WATERPROOF DRY CHEMICAL Lasts for Years—No Recharging Needed.
- NON-TOXIC—Safe on Gasoline and Electrical Fires.
- ENDORSED BY INSURANCE COMPANIES—Tested and Proven for Over 30 Years.
- REFILLABLE—Equipped with Hanger and Refill Usable as Auto Extinguisher.
- 30-DAY MONEY BACK GUARANTEE

ORDER BY MAIL \$6.95

2 FOR \$12.00 POSTPAID

Comparable Extinguishers Cost 4 Times This Price!



AUTO EXTINGUISHER INCLUDED AT NO EXTRA COST

FREE—Send Today

16-page illustrated booklet "HOW TO GET OUT OF A FIRE ALIVE!" Contains seven rules to save your life in a fire, plus information on how to prevent fires.

HUDSON MFG. CO. Sheridan 1, Michigan

Please send your FREE booklet "HOW TO GET OUT OF A FIRE ALIVE!"

NAME.....
ADDRESS.....
CITY.....STATE.....

WHAT TO SAY ON 1001 OCCASIONS

Practical handbook for the "amateur" speaker

Now you need never again be at a loss for words when addressing your club or organization! **WHAT TO SAY AND HOW TO SAY IT** gives you tested models of speeches and letters that always win a hearty reception. David Belson—a prominent attorney active in community affairs for more than 25 years—not only tells you what to say but also shows you how to say it most effectively. **Send No Money! Examine WHAT TO SAY AND HOW TO SAY IT for 10 Days FREE!** See how much the book does for you. Then either remit \$3.50 plus a few cents postage or return the book and pay nothing. Write today to:

Citadel Press, Dept. W-25, 222 Fourth Ave., N. Y. 3, N. Y.

Word-for-word models you can use for:

Nominations
Presentations
Appeals for Funds
Resolutions
Citations
Introductions
Installations
Tributes
Congratulations
Dedications
Condolences
Awards
Speech Openings
Closing Remarks
Greetings
Etc., etc., etc.

WHEN SENSES DULL YOU NEED HULL AUTO COMPASS

One of the common causes of lost directions is reduced alertness as miles roll by. Wrong turns are almost inevitable—unless you drive by Hull, the world's most widely used auto compass. At your dealer's or write for literature.

Beaconlite \$6.50 Streamline \$4.95
HULL MFG. CO. P. O. Box 246-EE1, Warren, Ohio



PRINTS POSTAL CARDS

Amazing New Advertising Machine!

Learn how businesses are now boosting sales in spite of conditions—with ad messages—printed on government postals with amazing new patented **CARDMASTER**. Guaranteed five years. Low price—sold direct. **SEND NAME** for **FREE** illustrated book of money-making ideas and complete unique advertising plans. Send your name today to **CARDMASTER CO.**, 1920 Sunnyside Avenue, Dept. 10-B Chicago 40, Ill.



Cafe Run Your Own Diner

I show you how to get started just as I did; where to locate, 7 ways to get capital, money making methods, even how to run a sandwich business right out of your own home with only a few dollars investment. Write for free details. **School of Restaurant Arts, 322-D, Fremont, Ohio**

FALSE TEETH

That Loosen Need Not Embarrass

Many wearers of false teeth have suffered real embarrassment because their plate dropped, slipped or wobbled at just the wrong time. Do not live in fear of this happening to you. Just sprinkle a little **FASTEETH**, the alkaline (non-acid) powder, on your plates. Holds false teeth more firmly, so they feel more comfortable. Does not sour. Checks "plate odor" (denture breath). Get **FASTEETH** at any drug counter.

REAL ESTATE BE A BROKER

PAYS BIG! SEND FOR FREE, BIG, ILLUSTRATED CATALOG NOW! Graduates report making substantial incomes. Start and run your own business quickly. Men, women of all ages, learn easily. Course covers Sales, Property Management, Appraising, Loans, Mortgages, and related subjects. **STUDY AT HOME** or in classrooms in leading cities. Diploma awarded. Write **TODAY** for **FREE** book! No obligation. Approved for World War II and Korean Veterans
WEAVER SCHOOL OF REAL ESTATE (Est. 1936)
2020H Grand Avenue Kansas City, Mo.



Let me show you

HOW TO SPEAK AND WRITE LIKE A COLLEGE GRADUATE

I have helped thousands of men and women who have not had college training in English to become effective speakers, writers, and conversationalists. With my new **C. I. METHOD**, you can stop making mistakes, build up your vocabulary, speed up your reading, develop writing skill, learn the "secrets" of conversation. You don't have to go back to school. Taken only 15 minutes a day at home. Costs little. 32-page booklet mailed **FREE** upon request. Send me a card or letter **TODAY!**

Don Bolander, Career Institute
Dept. 472 25 East Jackson, Chicago 4, Illinois

Our February Cover



This month's cover painting by Allen Saalburg is a symbolic representation of the new arrangement at the altar, with the flag placed in a staff at the right of the altar as viewed by a candidate. In place of the flag, a beautifully decorated purple cloth is placed on the altar under the Bible and Antlers.

As explained in an article, "The Flag

at the Altar", that appeared in the September issue, from time to time questions had been raised as to the propriety of placing the American Flag over the altar, even though no organization has consistently regarded the flag with greater reverence than the BPOE.

On recommendation of the Committee on Judiciary that action be taken, the matter was referred to the Ritualistic Committee, which recommended that the flag be carried in a staff. This report was presented to the Grand Lodge at the Convention in Chicago last July and was adopted unanimously.

In view of the importance of this decision and the opportunity it afforded to prepare an idealized painting that would remind all members of the Order of the new arrangement of the flag at the altar, The Elks Magazine is particularly pleased to publish this cover for the month of February—the month in 1868 that the Order was born.

(Note: Through the helpful cooperation of Secretary Eugene G. Hefferman, New York Lodge No. 1 made available to a photographer its Bible, Antlers and Flag to obtain a basic pictorial arrangement from which artist Saalburg could prepare the painting and this assistance was very much appreciated not only by Mr. Saalburg but by the Magazine).

swelling. It took some courage but finally he made it and flexed the fingers, and the once broken hand was all right. Like the doc had said before, it was better, stronger than ever. There was still the other one, though. Danny watched the doc touch here, touch there and he held the pain-noise inside of him, not wanting to miss what the sawbones said.

"I think," the doc said, slowly, "it's all right. I don't think it's a break but a bad sprain, maybe a dislocation, a pushed-back knuckle. The pictures will tell. But it doesn't look like any break."

Then somebody cuffed Danny gently across the ear. He looked up and Jingo Jones was there and Jingo was having trouble with his Adam's apple and a puckering lower lip. "You knucklehead!" Jingo said. "Listen, don't kid me, you knew that hand was bad; you thought it was busted, too! I gave you the chance to quit. Why'd you go on? You could have ruined that paw so it'd never pound a piano again. No brains, have you? A knucklehead, a real dumbo knuckle-

head. Why? I ask you why you did it?"

Danny didn't say anything. He just grinned, all grin all over his face, and he knew that was enough of an answer because he saw Jingo's eyes crinkling at the corners too. "That was a big one. We won a big one, tonight, eh, Jingo?" he said.

A little later when Danny came out to Emily, waiting for him in the hospital reception room, he was smiling and shaking his head. She took the arm that wasn't in a sling and clung to it. Looking very blonde and very sweet and a little bossy, Emily told him: "That was The Kid's Last Fight, my friend. You can use your fists and play a piano like all-get-out, but you don't dance worth a dime. Not with partners like Buster McKoy."

"I know," Danny said, grinning. "I found that out." He felt good about it, though. And about the other things he'd found out, like that when you keep faith with your friends, with yourself, the little leperchauns of luck stay right there, perched on your shoulder. It was all very nice.

Rod and Gun

(Continued from page 10)

suggested that we wait at the base of a wooded hill, in an open space between the woods and a large cane field. Toward evening, he said, the birds would fly down from the hill to the cane, passing overhead and giving us a good shot. We would have only the one chance at each such group of birds. Once they were in the high cane, it would be futile to try to hunt them.

A Cuban guinea talks the same language as an American barnyard guinea. As they commenced to stir around on the hillside above us, we could hear their incessant, "potrack, potrack, potrack." It was too much for me. I put up with it for awhile, then got to my feet. Being an old hand at New England ruffed-grouse hunting, I announced that I was going up on

that hill and commence hunting, instead of just sitting and waiting for that one chance as they flew over. It might be thick up there, but so were some of the tangles where I hunted grouse at home. Ernesto didn't stop me. He knew I would learn soon enough for myself.

I learned, all right. That was my first practical lesson in Cuban guinea-hen hunting—and it is the last time I ever intend to get caught on a jungle-clad Cuban hillside. It's not only a wild tangle of vines and twisted limbs, but practically everything that grows there is covered with thorns—not just straight, sharp thorns, but thorns with hooks on the ends, like the claws of a cat. But I'm not only a restless hunter, I'm a bit bull-headed. I fought my way half the distance to the top of that hill until I could hear guineas all around me. Another twenty feet, I thought to myself, and I'll fly some of them. I got down on my hands and knees and crept through small openings; then went down on my belly and wormed my way along. Suddenly I could go no farther, as though I had come to the tapering end of a cave, and when I tried to back out, I couldn't budge. Hardwood limbs pinned me to the ground, and talon-like thorns held me in place. I've never suffered from claustrophobia, but that would have been as good a place as any for an attack of it. I had to tell myself to take it easy and work my way back out inch by inch, even if I failed to make the trip back down the hill in time to do any shooting. Meanwhile, all around me the guineas continued to go, "potrack, potrack, potrack."

WHEN I did finally arrive back in the clear—with a few scratches, but none the worse for wear—Ernesto didn't say a thing. He's a gentleman. He merely suggested that I take a stand a couple of hundred yards down the line so that the guns would be well spread. I didn't arrive any too soon. The birds commenced to fly while Ernesto was still giving me my instructions. I stopped to take a picture or two of the guineas that dad and Ernesto brought down out of the first bunch, then hurried to my stand.

As soon as I was stationed I heard shooting behind me, then more shooting. I watched and saw a small bunch leave the hill and come sweeping down across the evening sky. They had a good head of steam by the time they crossed the clearing—in fact, I was amazed that anything that looks like a guinea could fly so fast—but one tumbled as Ernesto's gun cracked. Farther down the line I saw dad drop a double. But none came over me. Nothing happened for fifteen minutes. Then, about fifty yards ahead, I saw a rather large bunch of them trying to pull a slippery African trick. They were cautiously emerging from the wooded tangle on foot. Instead of flying overhead, they were going to make a run for the sugar cane.

As they made a break and started their dash across the clearing, I went into high gear in an attempt to cut them off and

put them in the air. Some people think a pheasant is a runner. He isn't in it compared to a guinea. Those things can really eat up the ground, but, when necessary, I'm no slouch myself.

I gave it all I had in an effort to intercept them, and as I ran my eyes focused on a bird near the center of the flock. It was pure white. An albino! I was excited enough about the prospect of getting my first shot at a guinea hen, but an albino! That was something rare. If I could only flush them before they reached the cane field! Suddenly they burst into the air, like a covey of quail. I slammed on the brakes and took quick aim, and I made it good. I saw the white one crumple at the very moment that he disappeared into the cane.

Without shifting my eyes for an instant, I hurried to the spot where he had vanished. The cane towered high over my head as I entered it, and the growth was so dense that it was almost dark inside. I had a sudden fear that I might lose my trophy, but I followed the line of his flight carefully and soon found a white feather. Another twenty feet, where his momentum had carried him, I found the albino guinea. This was my share of luck even if I failed to get another shot.

Darkness falls fast in the tropics, and in another twenty minutes the hunt was over, and I was the proudest one of all. I approached the others, swinging my white guinea nonchalantly—but conspicuously—by my side and wearing a look-at-me expression all over my face. I waited for an exclamation from the other hunters, or from one of the admiring bystanders who had gathered from the *finca*, but no one said a word. Someone had to call attention to my prize, so I opened my mouth to explain the significance of an albino—how rare it is to bag one in any species—when I happened to glance at Ernesto. The Spanish people can't help but betray their emotions outwardly, and Ernesto didn't appear exactly pleased. The corners of his mouth were turned down so far that even his eyes drooped. I began to get the idea that my accomplishment wasn't fully appreciated.

Ernesto never did tell me directly what was wrong. I had to piece it together second hand. It seems that a white guinea hen in Cuba is granted complete immunity; that he is surrounded with an aura of respect amounting almost to a superstition, but it is a superstition based on practical considerations. The Cubans want the guineas for food, but the birds have gone wild, so wild that it is often difficult to locate a flock, let alone shoot any of them. However, if there is an albino among them, he is always conspicuous. Any time the flock ventures into the open to feed, it is immediately evident—even from a distance—by the presence of the white one. A plantation owner who has a white guinea hen considers himself quite fortunate.

Prior to that hunt I thought I knew all there was to know about hunting guinea

Here's a truly complete, mechanized accounting plan for every size business

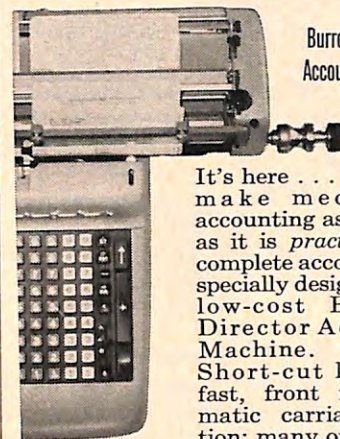

Burroughs Director Accounting Machine

It's here . . . the way to make mechanized accounting as *economical* as it is *practical*! It's a complete accounting plan specially designed for the low-cost Burroughs Director Accounting Machine. Features? Short-cut keyboard; fast, front feed; automatic carriage tabulation; many others.

Burroughs accounting machines priced as low as \$510.

—Send for FREE booklet!

BURROUGHS CORP.
Detroit 32, Mich.



EM-60
Please send me your new booklet: "A Complete Accounting Plan for Burroughs Director Accounting Machines."

NAME _____
ADDRESS _____
CITY _____ ZONE _____ STATE _____

PIONEER BOATS



Pioneer's press-formed 14' 8" aluminum boat is the most beautiful of all runabouts! 7 steel and 6 aluminum models. 28 sizes! Send post card for FREE Catalog.
PIONEER MFG. COMPANY, 712 Perry St., Middlebury, Ind.

Elks! FOR ALL MEMORABLE OCCASIONS BRONZE PLAQUES

Say it better . . . Say it forever . . . Say it for less
U. S. Bronze leadership in quality and artistry is forever impressing everywhere, and low prices keep our customers pleased, too. Write now for new complete FREE color catalog and information — helpful suggestions for honor rolls, awards, memorials, testimonials, for everything. Write to

"Bronze Tablet Headquarters"
UNITED STATES BRONZE CO., Inc. SIGN
570 Broadway, Dept. E, N. Y. 12, N. Y.

Own a BUSINESS Earn \$8,750 FIRST Year



World-Wide Start part time if you wish. We locally train you to run your own business. furnish all equipment and supplies to clean & moth-proof rugs, upholstery on location by unique world-wide process. No shop needed, you become quick by established. Just 2 average jobs a day bring \$8,750 NET profit in year. Employ others and multiply your earnings. As member of world's largest organization of its kind you are backed by National Advertising. receive regular services to help build your business. You will be only one in town whose process bears famous Parents' Seal. Business grows rapidly due to recommendations and repeat jobs. Easy terms. Send now for fascinating FREE booklet with full details.

DURACLEAN CO., 7-542 Duraclean Bldg., Deerfield, Ill.

hens in Cuba. I was wrong. Now I know, but it's too late. That was my first guinea-hen hunt—and my last. We weren't in-

vited back the next time preparations were being made for a family dinner. As far as I know they ate chicken. I did return

to Cuba a third winter, but no one ever mentioned guinea-hen shooting—especially me.

North Return

(Continued from page 5)

the trapper had lured him to his own place, muzzled and chained him, canoed him a hundred miles to steel-end and sold him to a menagerie buyer.

During all the slow kaleidoscope of towns and jolting truck trips and hot, crowded tents, the longing had obsessed Katokah to be back in that wild, stern land again. Except for those shadowy memories of parents and litter mates, he knew his own kind not at all; the trapper had killed them all out. But he was young, with the deep need of the young for company and the sense of belonging, and at night he would lie whimpering in his cage for the only home and kin he knew—the big hardrocker and that cabin on the river.

Around him the light, local ground-airs that stirred and died told him little, but the persistent night wind out of the north-northwest carried many layers of massive scents and held many meanings for his talented nose. The same kind of alien country as surrounded him now extended on and on north for several hundred miles; and in a vague way he was aware that those leagues of settled man-country, with their dog packs, auto roads and other dangers, would be an almost impossible barrier for him to traverse.

And beyond this barrier lay still another, this one still more daunting. Faint-

ly his nose made out the presence of a great waters in that direction, blocking his way. Far larger than any river or lake of his experience, it was like an inland sea, and as he studied it and interpreted the wind-clues to it, he knew instinctively that it was much too wide for him to swim, much too huge for him or any other land creature to pass over.

A rifle shot down the south slope of the hill the leaders of the dog pack came bursting out of the pines—a redbone hound, a chow, a female collie. Katokah threw them only a glance, then turned back quickly to his probing and interpreting. For beyond the great waters lay a country that was totally different from the man-country around him. It was so far away that his nose-clues to it were mere whispers of scent, but their message was unmistakable and it set his blood surging. No settled land, that country lying below the distant horizon, but a land of far-flung spruce and minaret pine, of countless loon lakes, red-granite swells and rolling sub-Arctic tundra.

When the three dogs reached him, with the others strung out down the slope, he snarled a warning and tried to back away from them. Like all his tribe, he indulged in no purposeless fighting or killing; he wanted only to be off for that country that

was pulling at him as though by an unseen leash.

More sensible than the other two dogs, the redbone began circling him warily, keeping at a safe distance. As though knowing that the wolf would not harm her, the female collie rushed in, snapping at his hind legs and haunches, and the chow, a chunky, vicious dog of good size, sprang in and tried to seize him by the throat. Against the collie Katokah did no more than defend himself, sidestepping her and shouldering her away. But the chow he met fang to fang. Taking a few bites on his chest and legs, he rode the dog down, killed it with one grab and shake and slung the limp form aside.

Before the rest of the pack could get there, he shook off the collie, drove the redbone back with a lunge and snarl, and fled out along the ridgeline of the hill spur. For a few minutes, till he dropped his pursuers hopelessly behind, he ran at a dead gallop. Then he slowed to the effortless, loping pace-gait of the wolf, and set out on his long journey home—heading for that horizon where the Big Dipper swung low and hazy in the northern sky.

ON A BIRCH HEADLAND that jutted out into the great waters, Katokah was pacing the landwash back and forth, in a tormenting dilemma. In the whippoorwill dusk he had twice waded out across the belly-deep shallows and started swimming, and twice his instincts, warning him that he could never make that passage, had led him to turn back ashore.

Stretching endlessly out of sight to the east and endlessly to the west, the great waters were a barrier he could neither circle around or cross. A score of miles to the left he could see the sky-glow of a big industrial area, and to the right another glow, even larger. And to the north, squarely in his path, lay a hundred and fifty miles of tossing gray waves.

After many days of little or nothing to eat, he was gaunt with hunger, and his long flight had worn him down. Lying up by day in isolated places and keeping to the timbered hills whenever he could find any, he had traveled only during the friendly night, swinging wide of towns and cities, and outfighting or outrunning the packs of farm dogs that got onto his trail. But in spite of hunger and the weariness of those half a thousand miles, his purpose still burned in him like a flame—to rejoin his master in that solitary land beyond the great waters.

As he gazed out through the gathering dusk at the white-sailed pleasure craft, the fishing smacks, the ore steamers and a distant excursion liner with a hundred eyes, his attention was suddenly caught by the smell of prey. It was no picayune rabbit

ELK HISTORIES GIVEN IN MASSACHUSETTS

Massachusetts' Governor Christian A. Herter, a member of Brookline Lodge and the new Under Secretary of State, left, accepts a copy of the Order's History from Past State Pres. Elmer A. E. Richards, center, and D.D. William F. McArdle, right. A copy was also presented to Lt.-Gov. Sumner T. Whittier.



P.E.R. Edward H. Lutsky, left, and State Sen. Philip G. Bower, as members of Brookline, Mass., Lodge, present a copy of "The History of the Order of Elks" to Miss Elizabeth Butcher of the Brookline Public Library. The book was graciously acknowledged by the Library's Board of Trustees Chairman R. I. Hunnerman.

or woodchuck but big meat, deer, and it stopped him in his tracks, his hunger clamoring.

In a few seconds of probing the air, he determined that the scent was coming from a wooded area a mile west along the lake shore, and it came not from one deer but from a band of a dozen or more.

With his dilemma about the great waters still unsolved, he swung back into some brushy sand-dunes and made his way toward the expanse of woodland where the white-tails were stirring in the twilight.

At the edge of the woodland he was stopped by a fence of woven steel-wire, too high to leap over, too strong to tear through, and footed so deeply in the ground that he could not dig under it. From the concealment of a sand-bush thicket he peered through the steel netting uneasily, puzzled by the acres of lawns, the rock gardens, the big house and servitor cottages, the oaks, evergreens, and ginkgo trees of the sumptuous lake-shore estate.

The queer, disquieting place seemed to him even more forbidden and dangerous than the farmlands he had passed through. What troubled him was the unnaturalness about it. There was no undergrowth or mossy, rotting logs, no drift of autumn leaves, and under the evergreens, cut to shape of urn and pagoda, there was no silent, sweet-smelling carpet of needles. Around the artificial pools and tarns he made out forms with the likeness of goose and trumpeter swan, of elk and leaping puma, but his nose told him that the things were stone statuary, cold and dead.

As he crouched there he picked up the scent of several dogs inside the estate, of some breed unfamiliar to him. Their cold trails, crisscrossing the grounds, indicated that they patrolled the place at night, guarding it against any trespassers, and they seemed to be dogs of large and dangerous size.

But he was hungry, the deer scent warm and close, and he started back along the steel netting in search of a place where he could get through.

At the south side of the estate he came to a spot where a recent windstorm had blown a tree across the fence, and the temporary repairs there were of chicken wire. With a little slashing and tugging, he tore a hole in the meshing, slipped through and then he found himself inside the strange grounds.

Following a bridle path among the trees, he passed a rustic bower and rustic bridge and the green lodge of the gamekeepers. Approaching cautiously from down wind, he finally caught sight of his quarry, in the mantling dusk—a band of fourteen deer, eating from metal troughs hung against the oaks. Compared with the lean, swift white-tails he had known, they seemed fat and slow of foot, and their natural alertness was so dulled that he bellied up within a dozen paces of them without being seen or heard.

In the way of a wolf stalking prey, he



One of the most outstanding cooperative efforts with Grand Exalted Ruler Bohn's "Get Out The Vote" campaign was conducted by Augusta, Georgia, lodge under the chairmanship of Brother Doughty Sylvester. The lodge awarded two \$25 Government bonds for the two best letters on the subject "Why every voter should vote." As Exalted Ruler Abe Fogel said to an Augusta newspaper, "The goal is to get every eligible voter in the city to the polls on Election Day." In the photograph above, Brother Sylvester is shown presenting first-place winner Brian Mulherin with his award.

studied the deer one by one, selecting the slowest and least wary. When he launched himself at them like a gray bolt, they broke away from the feeding troughs, with a flip of tails and a snort of panic, and went thudding back through the trees. All except a sluggish spike buck. In a few leaps Katokah overhauled it and pulled it down, and killed it with a wrench and slash of his tremendously powerful carnassial teeth.

He had not yet started feeding when he heard a deep, throaty bark from the direction of the hole he had torn in the fence. Presently he caught the *pad-pad* of running feet and a few seconds later, down an avenue of the trees, he saw three large white dogs appear, trailing him swiftly, silently. Wolfhounds from the Carpathians, they lacked his weight and power, but they were nearly as rangy as he and there were three of them against his one.

They came on and on, coursing his trail in long curves, but he made no move to escape or back away. The spike buck was his kill, his food and possession, and he stood over it defiantly, hackled up, snarling his low warning snarl, till the three finally caught sight of him and came rushing in.

Like the trained fighters they were, they fanned out and came at Katokah from three sides. But he was wise to that tactic; in his battles with dog packs on the journey north he had learned the bitter lesson of the ring-attack well. Instead of fighting at bay, slashing now at one and now another of his enemies, he lunged forward to meet the nearest dog, closed with it and battled it to a finish. Fangs clashing, the two of them rose up on hind legs, feinting

monroe FOLDING BANQUET TABLES

Direct Prices & Discounts to Clubs, Churches, Lodges, Schools and All Organizations

COMPLETE CATALOG ON REQUEST



MONROE TRUCKS

For handling and storing folding tables and chairs. The easy, modern way. Choice of models.



FOLDING CHAIRS

Steel built, sturdy, convenient.

PORTABLE PARTITIONS

Change your idle space into useful areas with these Partitions. Masonite panels in tubular steel frames with swivel action pedestals and casters or glides.



THE Monroe COMPANY
90 Church St. Colfax, Iowa

Anatone gives healthful support, slim appearance



Supports sagging stomach muscles. Helps you get blessed relief from nagging backache. Slims inches off your waist. The scientifically-developed ANATONE BELT now helping thousands of men in all walks of life. Made of elasticized fabric with reinforced stitching, special stays to prevent wrinkling and rolling. No crotch piece. Feel and look younger... results guaranteed or purchase price back. Waist sizes 26" thru 52"

Unconditional Money-Back Guarantee \$4.98

10 day free trial...send no money

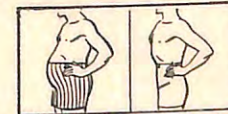

MAGIC-MOLD Inc., Dept. A18B
467 Livonia Ave., B'klyn 7, N. Y.
Rush me on 10 days' FREE TRIAL an ANATONE BELT. I will pay postman \$4.98 (plus postage). If not completely satisfied, I may return the ANATONE for full refund of purchase price.
My waist measure is inches
Name
Address
City Zone State
 Save money. Enclose money now and we pay postage. Same money-back guarantee.

IF \$1,000 A MONTH INTERESTS YOU—



here's an amazing new way to make it Fast!

I have an invention needed and wanted by millions. While this invention is new, it's been tested for sales appeal, and it's magic. Salesmen and distributors are making sensational profit records and the market is hardly scratched. Sells at low price with high profit on dramatic 2-second demonstration for homes, offices, autos, factories, farms, boats, etc. Big potential selling stores. If you can take hold of a hot item and get the most out of it, write me immediately. I'll send you all the facts, free. C. Wesley, 114 E. 32nd St., New York 16, N. Y.

BUY DIRECT FROM FACTORY SAVE MIDDLEMAN PROFITS

MASTER MECHANIC PORTABLE LIGHT PLANTS

Push Button Start—700 watts 115 v. 60 cye. AC. Powered by a rugged 2.2 hp. easy starting Briggs gas engine. No wiring necessary. Just plug in and operate. Plenty of current for any radio, television, oil burner, freezer, pump, lights, etc. which require up to 700 watts. Ideal for camp, cottage, trailer or boat! Includes voltmeter and built-in winding to charge 6 v. auto batteries. Wt. 75 lbs. Easily fits in car trunk. Be prepared if store checks out power lines. Fully guaranteed. Regularly \$275 **\$143.50 special.**

1200 Watt Plant (Item 43) same as Item 24 but with larger generator & engine—50% greater output \$199.50
Send 10c for big 1937 Catalog. Free with order. Prices f.o.b. factory. 10 day money back guarantee. Send check or M.O. Master Mechanic Mfg. Co., Dept. 91-P, Burlington, Wis.

A POSTCARD CAN PUT YOU IN A FINE BUSINESS!

Rush Card TODAY for FREE OUTFIT!
Get in highly profitable, repeat-order shoe business! Sell amazing line of Air-Cushion Insoles, comfort shoes to friends, neighbors, fellow workers. Dress, sport, work, safety shoes for men, women. Never sold in stores. Just 2 orders a day—in spare time—brings in \$168 EXTRA income a month! No investment. Send card TODAY for FREE SELLING OUTFIT! MASON SHOE MFG. CO. Dept. 535, Chippewa Falls, Wisconsin.

HONOR ROLLS — MEMORIAL TABLETS BULLETIN BOARDS & SIGNS
For Indoor or Outdoor Use
NEW LOW PRICES
Write for our new Free Catalog
UNIVERSAL BULLETIN BOARD CO.
912-916 BROADWAY, NEW YORK 10, N. Y.
Telephone GRamercy 3-7426

ADDRESS LABELS \$1 1000 PERSONAL
Up to 4 lines handsomely printed with your name and address in black on gold-bordered, gummed paper (1/2 x 1 3/4 in.). **PLASTIC BOX INCLUDED.** Save time. Protect possessions. Use on envelopes, checks, parcels, books, records, tools, toys, etc. **SPECIAL SPRING OFFER 100 for \$1 ppd. ANY 5 ORDERS \$1.** Guaranteed to please. Write Bruce Bolind, 20 Bolind Bldg., Montrose 47, Calif.



Keep wraps in an orderly manner—aired, dry and "in press". No. 3 wall racks come in any length to fit; 4 spaced coat hangers and hat spaces per running foot. Mount on wall at the desired height for each age group. The 5 ft. Portable No. 50 Checker accommodates 50 people, goes wherever needed on large ball-bearing-swivel casters. Answers the wraps problem in vestibules or for meetings, dinners, etc. Efficient, sanitary, fireproof and quality built for lifetime service of welded, heavy gauge steel with square tubular columns.

Write for Bulletin CK-3
Wardrobe units for every church need including portable umbrella and overshoe racks for entrances, and storage racks for robes.
VOGEL-PETERSON CO.
The Check Room People
1127 West 37th St., Chicago 9, Illinois

and parrying as they fought for a throat hold. The other two wolfhounds were attacking him savagely, ripping and slashing, but he stayed with the first one till he overpowered the dog and clamped on that fatal hold.

Only when the wolfhound lay thrashing and dying on the grass did he whirl on the other two. In a fury from the punishment he had taken, he locked with the second dog, huddled it on even terms for a few minutes, grimly giving and taking, but swiftly he rode it down, killed it, then turned on the third and last.

But this one, finding itself alone now, sprang back from his lunge and refused battle, and as it kept backing away and eluding him it lifted the long wolfhound bark of "quarry at bay" to summon help.

Out through the trees Katokah saw lights come on at the green lodge. Still guarding his kill, he watched two men come running out, one with a searchlight, the other loading a gun, and hurry toward the baying. Presently the searchbeam picked up the white dog, then swung on him, blindingly, and he heard an astonished shout:

"Look't it! O wolf! Big timber wolf!"

The shotgun *kroomed*. Most of the shot splatted harmlessly into the sod beside Katokah, like angry, storm-driven sleet. Only one pellet struck him, a mere sting in the shoulder, but he was suddenly afraid. Forgetting the spike buck and his hunger, he whirled around and made for the sheltering darkness beyond the flash-beam.

It was the two men, not the dog or even the gun, that he was afraid of. He had learned that there were men and men. Like the kindly prospector—and the trapper who had muzzled and chained him. Like the carnival owner, who prodded and half-starved him to make him "feer-roo-cious"—and the keeper who sometimes slipped around at night with extra feed and patted the "one and only Man-Eater" and talked with him in low, partnerly voice. And the two men yonder were men of the sort to fear.

In a few moments he had outrun the flashbeam. As he made a big circle around the men and the lodge, the wolfhound kept close behind him—but not too close. At the fence he leaped through the hole he had torn in the chicken wire and was out of the queer woodland.

A thousand yards down among the dunes he stopped, listened, heard no pursuit, licked his wounds briefly, then went on toward the headland. All his uncertainty and dilemma were gone now. He sensed there would be no safety for him till he got back to that wild, solitary land of his memory. After the many dangers of the settled country he had passed through, and now this last fearsome experience in the woods that was somehow not a woods, he wanted no food, rest or anything whatever except to be pushing on and on toward that untamed country of the Long Sun and the Long Dark.

At the tip of the headland he waded

out through the shallows to deep water and started swimming.

IN the slow dawn broadening over the gray watery wastes, a two-man fishing smack was chugging homeward, empty-handed, from the white-fish grounds in the middle deeps of the lake. At the wheel on the foredeck a stocky, redheaded man of thirty was moodily watching the mew-ing gulls, the shimmer of a surfacing perch school, the high roseate cirrus in the morning sky; and in spite of a deep, abiding trouble in his eyes, a certain contentment rested on his face, as though the familiar wilderness of sky, clouds and waters was one kind, *his kind*, of wilderness—the eternal frontier of lone waters.

Suddenly he broke off a yawn, stared out across the loping waves, then pointed excitedly.

"Clarney, look! Over yon, apart, there's something—some animal—swimming along—"

"Log, probably," the older man on the aft deck grunted. "A steady nor'-wester like we've been having always brings drift out of the Ontario bays."

"I tell you it's alive," the younger man insisted. He veered over toward the puzzling thing. "Blow me down, it's a dog, Clarney! A dog, 'way out here—must have jumped or fallen off a boat." But then, as the smack chugged closer: "No, it isn't any dog. Look at that brush. And you ever see a dog that big? That's a wolf!"

The older man nodded. "Wolf, all right. Used to hunt 'em when I was young. Used to be lots of 'em in the North Shore woods. But been none for years now. Never did see one that big. A whopper like that, he must have come from the Hudson Bay country."

The redhead gazed down with pity at the spent gray form. "Whopper or no, that fellow's just about had it. Can hardly hold his nose out of the water. Look, Clarney, we're going north and that's the way he seems to be heading—how's about hauling him aboard?"

"Not on my boat," Clarney growled. "That brute could take a man's leg off. We've had trouble enough on this trip, 'thout taking on a cargo of grief like that." But as he studied Katokah, the great size of him and the silver-tawny color, he was silent, his eyes narrow and calculating. "Hmmp. A genu-wine northern timber wolf—getting to be scarce items—that'n seems to be sound and healthy—hmmp. All right, we'll haul it in."

They dropped a length of seine over the side, circled around Katokah, pursued him and dragged him up onto the net-drain boards, limp and soggy as a huge gray mop.

The boat drifted, rocking in the waves. Katokah lay quiet on the deck, too bone-weary at first to move. The older man had got a pistol from below and he kept his hand on it as he saw signs of strength returning to the big wolf. But the redhead squatted down near Katokah and looked

him over, with eyes that were curious but unafraid and friendly.

"Hi-yuh, big boy. You're one for the books, swimming along out here in the middle of nowhere. Wherever you were heading, you must've wanted to get there bad. Look now, I've sort of gone parole bond for you, and you'll take it easy around us, huh?"

The voice was soothing and kindly, and Katokah wagged his tail feebly in response to the friendliness. The redhead's eyes widened in surprise.

"See that, Clarney? Wagging his tail! A *wild* wolf wouldn't do that."

The older man was watching sharply, chewing his lip. "Hmmp. Somebody's had that wolf. He ought to be easy to handle. Might even be a trained animal. Try him out some more."

"First off, I'm getting him some food," the redhead said. "Look at those ribs. He hasn't had a square meal since when."

He brought up a generous pan of breakfast stew, and Katokah ate. Then he said "Lie!" and Katokah obediently lay down, his head on his forelegs. He tossed the wolf a small fish and said "Catch" and Katokah caught and bolted it. He said, "How's about shaking hands, guy?" and Katokah wagged his tail and lifted his right front paw.

"That wolf," the older man remarked, "is worth money. At Baie du Bois Fort there's a fellow got a menagerie farm, goes around buying animals—he'll give five hundred dollars for that wolf quick as a wink."

The redhead's smile died. "Selling him, a wild-born thing like him, to be cooped up—I can't go along with that, Clarney."

The older man bristled. "Who cares what you go along with? I'm boss of this boat. 'Sides, a person in your shoes—"

"That again. Always dragging that out, like a club. Well, this is one time it won't work. We're going to let this wolf loose."

"Are we?" The older man's voice turned hard and threatening. "A person the Mounted is looking for, with a year more to lay out in the pen—*Are we?*"

For a few moments their stares met and clashed, and the redhead clenched a big fist. But then he swallowed hard, looked

down, slowly turned away and began mending net. The older man crossed the catwalk to the foredeck, pushed the engine throttle to full, took the wheel and set a course northwest by north toward the Ontario shore and the menagerie farm at Baie du Bois Fort. . . .

It was near sunset when they rounded a cluster of rocky islets and before them, at the head of a deep bay, the wharf and white houses and summer-tourist bungalows of Baie du Bois Fort swam slowly into view.

Restless and excited, Katokah was sitting on the aft deck near his new-found friend, who sat silent, thinking hard, a dead pipe in his teeth. For hours the big wolf, reading the wind across the waters, had been getting more and more fidgety and keyed up. He was aware that the country yonder was not yet his country, but the scents of his journey's end had been growing plainer, stronger.

The redhead put a hand on his shoulder, to quiet him and stop his keening. "Keep your shirt on, big boy. You're not going anywhere, if that's what you're thinking. Where you're going is back to the pen, and it won't be for just a year or so, either. It'll be for life."

Up fore the older man lashed the wheel and came aft, carrying a length of chain and a muzzle he had made of heavy wire and a strap. "Here, put these on him," he ordered. "People yonder will be scared of him if we don't. Or he might make a break for the woods."

"Put them on him yourself," the redhead said, in a low, slow voice. "I've about had a bellyful of your small-potato blackmail, Clarney."

The chain and muzzle struck fear into Katokah. He had seen those things before and they were evil things. And he was beginning to catch the scents of the bay-head town, and that too was rousing fears in him. Sometime he had been in that town before, and it was an evil place.

As the older man approached him he scrambled to his feet and backed off. The man's "Nice doggie" and show of friendliness deceived him none. Instead of obeying the command to "lie," he dodged aside, as the man tried to corner him on

If a cat can look at a king, an Elk can look at an eland, as Charles Donovan of Springfield, Mass., Lodge proved in Forest Park Zoo when he was photographed with a newcomer to the menagerie—a giant eland, weighing half a ton, a recent immigrant from Africa.



A New Pleasure In Hearing Quality

Maico's Brilliant New Hi Fi Hearing Aid

The high fidelity of normal hearing is now yours in Maico's new, five-transistor hearing aid.

Never before has there been such clarity of tone, such powerful amplification, such a range of individual adjustments, such a new dimension in high fidelity hearing, as available with this brilliant, new electronic triumph. Has more than 100 different fitting adjustments to correct even the most difficult or severe hearing problem.

If you are considering the purchase of a hearing instrument or are in any way dissatisfied with the tone quality in your present hearing aid, you owe it to your hearing to try Maico's new high-fidelity hearing instrument. See it now at your local Maico office, or write us for further information.

Maico

Room 16J, 21 North 3rd Street
Minneapolis, Minnesota

MAKE MONEY WRITING .. short paragraphs!

You don't have to be a trained author to make money writing. Hundreds now making money every day on short paragraphs. I tell you what to write, where and how to sell; and supply big list of editors who buy from beginners. Lots of small checks in a hurry bring cash that adds up quickly. No tedious study. Write to sell, right away. Send for free facts. **BENSON BARETT, Dept. 92-B, 7464 Clark St., Chicago 26, Ill.**

If Ruptured Try This Out

Modern Protection Provides Great
Comfort and Holding Security

Without Torturous Truss Wearing

An "eye-opening" revelation in sensible and comfortable reducible rupture protection may be yours for the asking, without cost or obligation. Simply send name and address to William S. Rice, Inc., Dept. 13F, Adams, N. Y., and full details of the new and different Rice Method will be sent you free. Without hard flesh-gouging pads or tormenting pressure, here's a Support that has brought joy and comfort to thousands—by releasing them from Trusses with springs and straps that bind and cut. Designed to securely hold a rupture up and in where it belongs and yet give freedom of body and genuine comfort. For full information—write today!



Past Exalted Ruler

#11—\$12.50. Another of the fine line of officially approved

Elks Pins. Write for illustrated folder to The Elks Magazine, 386 Fourth Avenue, NYC.

FREE FOR ASTHMA

If you suffer asthma attacks, choke and wheeze, find sleep impossible because of the struggle to breathe... try FRONTIER ASTHMA MEDICINE now! Get immediate, blessed relief from the dreaded symptoms of bronchial asthma. Over 1,000,000 bottles sold. FREE TRIAL bottle by return mail. You pay nothing. Send name and address now to: FRONTIER ASTHMA CO., 570-A Frontier Bldg., 462 Niagara Street, Buffalo 1, N.Y.

Skin Sufferers

Very first use of soothing cooling, liquid D.D.D. Prescription positively relieves raw red itch—caused by eczema, rashes, scalp irritation, chafing—other itch troubles. Greaseless, stainless. 45¢ trial bottle must satisfy or money back. Ask your druggist for D.D.D. PRESCRIPTION.

LOOK for Rupture Help



Try a Brooks Patented Air Cushion appliance. This marvelous invention for most forms of reducible rupture is GUARANTEED to bring YOU heavenly comfort and security—day and night—at work and at play—or it costs you NOTHING! Thousands happy. Light, neat-fitting. No hard pads or springs. For men, women, and children. Durable, cheap. Sent on trial to prove it. Not sold in stores. Beware of imitations. Write for Free Book on Rupture, no-risk trial order plan, and Proof of Results. Ready for you NOW!

BROOKS APPLIANCE CO., 329-H State St., Marshall, Mich.

EAT ANYTHING WITH FALSE TEETH

If you have trouble with plates that slip, rock and cause sore gums—try Brimms Plasti-Liner. One application makes plates fit snugly without powder or paste, because Brimms Plasti-Liner hardens permanently to your plate. It relines and refits loose plates in a way no powder or paste can do. No need to pass up your favorite foods. With plates held firmly by Plasti-Liner, YOU CAN EAT ANYTHING! Simply lay soft strip of Plasti-Liner on troublesome upper or lower. Bite and it molds perfectly. Easy to use, tasteless, odorless, harmless to you and your plates. Removable as directed. Money back guarantee. At your drug counter. Only \$1.50. Plasti-Liner Inc., Dept. J; 1075 Main St., Buffalo 9, N. Y.



BRIMMS PLASTI-LINER
THE PERMANENT DENTURE RELINER

DON'T PULL HAIR FROM NOSE

May Cause Fatal Infection

Use the **KLIPETTE** Rotating Scissors



You can cause serious infection by pulling hair from nose. Ordinary scissors are also dangerous and impracticable. No better way to remove hair from nose and ears than with KLIPETTE. Smooth, gentle, safe, efficient. Rounded points can't cut or prick skin. **\$1** Made from fine surgical steel Chromium Plated. So Simple! Just turn end. Surplus hair comes out easily, gently. Guaranteed to Satisfy or Money Back

HOLLIS CO. • 1133 Broadway, New York 10, N. Y. • Dept. K-24 Enclosed is \$1.00 for KLIPETTE. If I am not entirely satisfied, I may return it within 10 days for refund.

Name _____ Address _____

the net drain, and sprang across the catwalk to the foredeck.

When the man followed him with the muzzle and chain and penned him against the spune shield, he started whimpering and looked around for some way of escape. But there was no way, no further retreat. Just as the man was reaching for him, he crouched and leaped over the shield, hit the water and started swimming for the nearest wooded point.

Behind him he heard an oath of anger and disappointment. Then the redhead called out a sharp warning: "Clarney! Put that gun back in your pocket. You shoot him and so help me I'll make chum of you." He started across the catwalk to back up his warning with his fists.

"You'll pay for this plenty," the older man snapped at him.

"That's the last time you'll threaten to turn me over to the Mounted," the redhead told him. "Know why, Clarney? Because I'm going to turn myself in. I've been thinking this all over, and that's what came out. If I go on like this, you and the likes of you will have me over a barrel the rest of my days. So I propose to go back and lay out my time and have it over with."

NIGHT had come early, that murky November day, and the first snow of winter was falling. In the windy darkness Katokah, foot-sore and gaunt as a scarecrow, was circling warily around the cabin on the riverbank.

The scents and sounds coming from the cabin had plunged him into another tormenting dilemma. The birch smoke tumbling from the eaves pipe and the light shining from the small "blizzard windows" were familiar and reassuring, and the rumbling voice of his master inside stirred an almost irresistible impulse to go up and scratch on the door and keen to be let in, as of old. But the trapper was in there, the man who had muzzled and chained him, and canoed him off to the alien land. The memory of those days, of his bewildered helplessness, was burned into his brain, and the mere scent of the man set him trembling with fear.

But as he circled the cabin half a dozen times, he drew nearer it each time, willy-nilly, till finally the voice of the hardrocker and the odor of a roasting caribou haunch overcame his wariness and fears. Timidly he crept up to the cabin door, ready to whirl and flee, and scratched at the bear-proof planking and got out a sort of "woof."

A silence fell in the cabin. Then the door swung open and his master stood before him. For a short time the big fellow could only stand there and stare at him, dumfounded. Then the man let out a roar: "Katokah!"

Because of the trapper, Katokah refused to go in. He sat in the shaft of light, wagging his tail, and offered his paw in greeting. Swearing big, hardrocker oaths, the man bent down, shook hands, gave him a thump in the ribs and half dragged him into the cabin.

Over by the sheet-iron stove the trapper, also dumfounded, pushed back his chair and hastily got up, completely forgetting the sack of "elementaries" he had cadged. "Think I'll be getting along home," he mumbled, sidling toward the door. "Storm coming on—and somehow I don't feel so good."

The hardrocker stepped in front of him, blocked his way, stood looking at him in a towering anger.

"You liar!" he thundered. "You told me that Katokah was dead. You said you found him in an old deadfall by the riverbank trail. All along I've had my suspicions. Last spring I heard a rumor that you'd sold a big wolf to some menagerie buyer. That was Katokah here. You stole him and sold him, you carcajou bait! I ought to break you in two."

"I didn't steal him. He must've run off and been living with other wolves around here—"

"What other wolves? You've killed 'em all out. That's another thing about you I don't like—fouling up this country with your traps and poison. Now this is the limit, your stealing my dog, and you're going to pack up and get gone. If you're down there the next time I come by, I'll throw you into the river and kick your shack in on top of you, and don't think I won't. Now put your foot in front of your nose and git..."

An hour or so later, after they had attended to the roast caribou and got reacquainted, they walked out into the snowy darkness, to stretch their legs before turning in for the night.

"This blow will bring on freezing weather, Katoke," the hardrocker said. "So tomorrow you and I'll start laying in our fish and caribou for the winter. You can stand considerable fattening up, from the looks of those slats of yours. Wherever you've been and however you got back, I can see it took some doing."

Katokah kept close to him, still with a linger of fear about the trapper. On the keen north wind, cold and exhilarating, he caught the odor of the mighty caribou traverse—of the dun herds streaming out of their summertime range in the Great Barrens to their winter yards in the "Strong Woods." But of his own kind, the packs that usually followed the migration, he could pick up no scent whatever or hear any distant calling from woods or tundra.

The prospector shook his head sadly. "No wolves," he remarked, as though he too had been listening for that night song of the wild lands. "But there'll be a few of 'em blizzard-drift down this way from the Thelon, later on. Country where you can't hear wolves in the Big Dark, it's no fit place for us."

Katokah did not understand the words, but the warmth and partnerly tone of them gave him a sense of being home again, after long and bitter exile. In the gusty darkness and crawling snow he stood tight against the hardrocker's leg, listening contentedly to the storm and the night.

"FREEDOM'S FACTS"—Youth's Challenge



This month on Page 34 Grand Exalted Ruler Fred L. Bohn has a special message to Exalted Rulers concerning Soviet attempts to infiltrate American youth, and for this reason this month's excerpt from "Freedom's Facts", a monthly bulletin of the All-American Conference to Combat Communism, is particularly timely.

Throughout the Communist Empire, students and young workers are studying and talking. As they do, they are learning that there must be a better way to live than under Communist tyranny. The result has been a series of revolts and demonstrations over the past two years. At first the revolts were small ones—some East Germans refusing to study compulsory Russian language lessons or Czechoslovak students lampooning the Reds in a university parade.

But during the past few months the revolts have become man-sized. The Poznan riots in Poland and the violent Hungarian revolt were set off and largely led by youth.

Even more recently there have been reports of student unrest in the Soviet Union. These have been mild expressions of youth's "right to know the truth" about world conditions. But they show a widening crack in young people's faith in the truthfulness of Communist rulers.

What must send chills of fear down the spines of Red leaders is that these questioning youth and these young revolutionaries are members of the "new generation". These are the young people top Reds have been counting on to build Communist society and to sovietize the world. In the words of Joseph Stalin, spoken in 1933: "The youth is our future, our hope, comrades. The youth must take our places, the places of the old people. It must carry our banner to final victory".

Something obviously has gone wrong with basic Communist theory. For more than ten years Red propagandists and teachers have used every possible means to indoctrinate Iron Curtain youth in militant Communism, since their training begins in kindergarten.

These children graduate into schools where a large part of their time is spent learning Marxism-Leninism. "Pravda" on May 5, 1956, reemphasized: "One of the most important inherent parts of Communist education is propaganda of the Leninist ideas".

As long ago as April 8, 1956, "Pravda" stated: "Higher educational establishments are training cadres of truly people's intelligentsia. Young boys and girls are being educated in the spirit of the ideas

of Marxism-Leninism, Soviet patriotism and proletarian internationalism.

"However, it would be wrong to overlook substantial shortcomings in the educational work of a number of higher educational establishments. . . . Party and Komsomol organizations do not pay sufficient attention to the ideological training of students. . . . The shortcomings must be eliminated."

Similar concern with the upbringing of youth has been shown in all the satellites. In urging more ideological training of Polish youth, Radio Warsaw on January 8, 1956, struck on a key to the later revolt of the youth against Communist tyranny. The radio commentator said: "The circles of thinking youth are now undergoing a crisis. They are fighting to learn the true values".

Communist leaders have been trying to sell youth inside and outside the Communist Empire on the idea that Marxism-Leninism is the truth. Outside the Communist Empire they have a network of youth groups. All are associated directly or indirectly with national Communist Parties—such as the Labor Youth League (LYL) in the United States. Most are part and parcel of the Reds' big youth front, the World Federation of Democratic Youth (WFDY).

The job of these groups is to sell the youth of free countries the idea that Marxism-Leninism is the truth, and let there be no mistake. They have made many successes. By their own claim WFDY membership has risen from thirty million from sixty-three countries in 1945 to eighty-six million from ninety-six countries in November, 1955.

A total of 380 delegations of young people from seventy-six countries were induced to visit the Soviet Union to take part in "youth festivals" and see propaganda shows put on by Communist youth. From these misguided youth groups have come many of the hard-core Communist Party members and the organizers of the Red front groups. From these groups have come leaders of rioting students in Singapore, Syria and Egypt.

But while the Reds have been making some progress among youth in Asia, Africa and elsewhere in the free world, they have been losing at home. The youth have been seeking the truth, and are now recognizing that what the Communists tell them is not the truth. They are learning that Communist tyranny means the deception, exploitation, and oppression of youth and of all people who submit to it. As one Hungarian student is reported to have said last month: "We felt we were in a dark tunnel and could not see the future. We saw no way out. We had no future."

The youth is the future of the world. Their search for truth, even under the hard conditions existing in the Communist Empire, indicates that our future ultimately will be free.

IF YOU ARE UNDER 80 YOU ARE NOT TOO OLD FOR LIFE INSURANCE

Let us tell you how you can still apply for a \$1,000 life insurance policy to help take care of final expenses without burdening your family.

You handle the entire transaction by mail with OLD AMERICAN of KANSAS CITY. No obligation. No one will call on you!

Write today for free information. Simply mail postcard or letter (giving age) to Old American Ins. Co., 1 W. 9th, Dept. L255M, Kansas City, Missouri.

FOR BIG MEN ONLY!

Sizes 10 to 16 **Widths AAA to EEE**
We specialize in LARGE SIZES ONLY—sizes 10 to 16; widths AAA to EEE. Dress, sport, casual and work shoes; golf shoes; insulated boots; socks; slippers; rubbers; overshoes; shoe trees. Also . . . sport shirts in your exact, extra-long sleeve length. Enjoy perfect fit in your hard-to-find size at amazingly low cost. Satisfaction Guaranteed. Sold by mail only. Write for FREE Style Book TODAY!

SEND FOR FREE CATALOG

KING-SIZE, INC.
133 Brockton, Mass.

The BALL CLINIC
THE BALL HEALTH SCHOOL, INC.
Dept. 759, EXCELSIOR SPRINGS, MISSOURI
Specializing since 1919 in the treatment of Rheumatism, Arthritis and associated chronic conditions.
WRITE FOR FREE BOOK TODAY!

NEW! CORDLESS HEARING AID!

WORN IN YOUR EAR

Dahlberg

Miracle-Ear®

New one-piece transistor hearing aid so small it is worn in your ear. No cords. No separate ear button. Easier to wear than glasses. Complete concealment for women. Wear "Miracle-Ear" . . . hear well again with natural freedom.

FREE INFORMATION... NO OBLIGATION
— USE THIS COUPON —

The Dahlberg Company Dept. B-16
Minneapolis 27, Minn.,
Please send free literature on the amazing "Miracle-Ear."

NAME _____
ADDRESS _____
CITY _____ STATE _____
Makers of the Famous "Optic-Ear" Hearing Glasses

51ks WORKSHOP



Handsaws—and How Best to Use Them.

BY HARRY WALTON



Besides rip and crosscut saws, you may need some of these. The 16" saw is a handy crosscut type. Pick the slimmest keyhole saw you can find if you have curves to cut. A coping saw with an extra-deep throat will cut farther from an edge than the common kind shown.

ALMOST every woodworking job you tackle requires some sawing. That makes saws just about the most important tools in your kit, especially if you use hand tools exclusively. Even if you have a power saw, there will be occasions when only a handsaw will do—for cutting an opening in a wall panel, for instance, or on-the-spot fitting of moldings and other parts of built-ins.

It pays to be particular when buying a handsaw. The first cost is only money, but a poor cutting tool can keep you paying, in extra labor, time and effort, every time you use it.

SHOPPING FOR SAWS. A reputable brand name, a well-fitted handle, and a good finish on the blade are more reliable buying guides than a low price. Try the saw in your hand; if it does not feel right, try another. See if the handle is parallel to the blade (Figure 1). One that's askew will tire you faster and tend to run off the cutting line.

Hold the saw pointing away from you, and sight along the toothed edge from the handle end to the tip. This edge should be absolutely straight, with no bow in it.

Seen from the flat side, the toothed edge may have a slight crown as shown in Figure 1. A good saw may be marked "hollow

ground" or "taper ground". This means the blade is thickest at the toothed edge and thinner elsewhere, which helps prevent binding and promotes free cutting.

THE TWO MAIN SAWS are the crosscut and the rip saw. The crosscut is for cutting across the grain, or to length. The other is for sawing along the grain, or to width. A crosscut saw should probably be the first you buy, for cutting to length is almost always necessary, while ripping to width is called for only occasionally.

The crosscut saw may be 24 or 26 inches long, with 8 to 10 points (teeth) per inch. This size is best if you have much heavy stock, such as two-by-fours, to cut. For lighter work, you might manage with the handy tool-box size, a 16-inch saw with 10 points per inch.

Crosscut teeth are bevel-filed both front

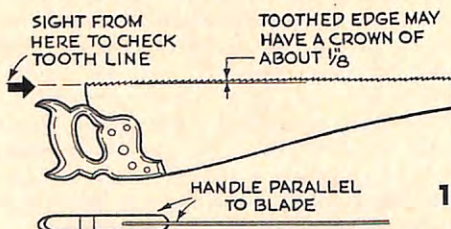

and back, alternately from the two sides of the blade, as in Figure 2. The sharp edges shear across the wood fibers, cutting two V-shaped grooves until they are deep enough to join in one kerf or saw cut, as shown.

To make sawing easier, the teeth are bent slightly outward, again in alternate directions. This causes them to cut a kerf about two-thirds wider than the thickness of the saw blade, in which the blade can run freely. But the set must be uniform for all teeth and the same on both sides; if uneven, it will make the saw wander off the cutting line.

The teeth of a rip saw are bigger than crosscut teeth, hence there are fewer to the inch (5½ commonly). They too are set to produce a kerf wider than the blade. But instead of being bevel filed, they are

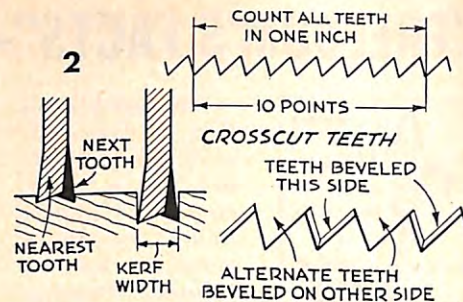

filed straight across at right angles to the blade, like a row of tiny chisels (Figure 3). They work much like chisels, ploughing a groove lengthwise of the grain.

THE TRICK TO SAWING is to work in a deliberate rhythm, making every stroke count and using as nearly the full length of the toothed edge as practicable. (Short strokes make the middle teeth do all the work and therefore dull prematurely.) Sawing rapidly or forcing the teeth into the wood gains little time, and makes the work harder. A good, sharp saw cuts with little more than its own weight and the natural downthrust of the cutting stroke.

START A CROSSCUT SAW with the teeth near the handle. Set them on the waste side of the cutting line as in Figure 4 (if you saw on the other side, the piece will be too short by the width of the cut).

Holding the thumb of your free hand against the blade just above the saw teeth to guide it, draw the saw back once or twice to cut a little starting groove. Continue with full-length forward strokes. As you approach the end of the cut, reach around with your free hand and hold up the unsupported piece so that it does not drop and splinter off.

START A RIPSAW with its front or tip teeth, which are usually slightly finer for that purpose. (Some new saws have fine teeth at the handle end instead.) Lift most of the saw's weight off the wood, letting it rest very lightly, and start with a slow forward cut. Once the kerf is begun, let the full weight of the saw rest in it and lengthen the stroke.

With either saw, keep your elbow close to the body, with the right shoulder, elbow and blade in line. Sight over the saw so that you can in effect see both sides of it. Hold a crosscut saw at an angle of about 45 degrees to the surface of the work, a rip saw at about 60 degrees (Figure 5). Holding a saw at too flat an angle makes too many teeth work at one time and slows down cutting action. At too great an angle, it will cut well but with splintering on the underside.

TIPS ABOUT SAW TROUBLES. When a cut deviates from the intended line, or it is not square, you can coax it

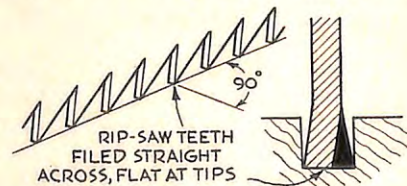

back by gently bending the blade or twisting it to the side, as the case may require, and using short strokes until the trouble is corrected. If a rip cut tends to close behind the blade, drive in a bit of wood shingle or a similar wedge-shaped piece to keep the kerf open.

When a saw binds in the cut, it may be because it has insufficient set (long use both dulls the teeth and bends them inward), or the wood may be damp or poorly seasoned, or you may have changed the angle of the cut. Oiling the blade may help, but avoid this if the work is to be glued, as oil may prevent proper adhesion.

If you must cut green or poorly seasoned wood, a saw with fewer points (say 7 per inch) and a wide set will work better than a 10-pointer. Cutting plywood calls for a crosscut saw, preferably with at least 10 points to the inch. Sawing at somewhat less than 45 degrees will help minimize splintering. Big sheets tend to sag and pinch the saw. Adequate support is the best answer. Another is placing the plywood in a vertical position and clamp-

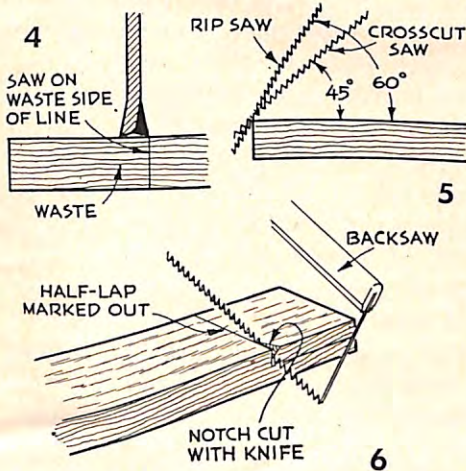

ing a two-by-two or similar piece of lumber near and parallel to the cutting line. This will give the piece enough rigidity to make cutting easier.

YOU MAY NEED A BACKSAW, if you want to frame pictures, install chair rail or molding, or do cabinet work. This is a short, fine-toothed saw with a stiff spine or backbone. It is usually used with a miter box for cutting to a precise angle.

Cutting tenons, dados and half laps for making joints is typical backsaw work. Use a hard, sharp pencil to mark the cutting lines. With a knife, cut a starting notch on the waste side as in Figure 6. Start the saw in the notch at an angle; then gradually bring it horizontal, as required for such work. The backsaw will also do the light ripping required in making the cheek cuts of these joints.

Miter boxes range from wooden ones costing a dollar up through elaborate ones priced thirty times that. Wooden boxes lose their accuracy as use wears the slots, but they will serve for occasional jobs. Better boxes, with adjustable metal guides for the backsaw, cost six to twelve dollars.

For really accurate angle cuts, always make a trial cut on scrap first. Check the

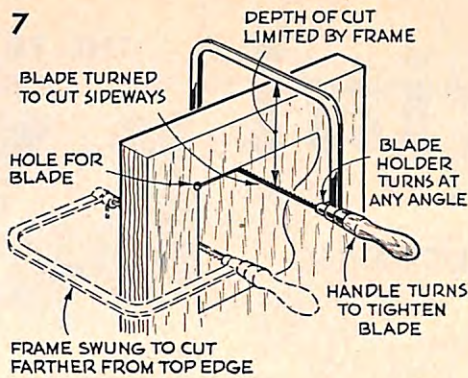

angle and make necessary adjustments on the box or saw guide before starting work.

SAWING INSIDE EDGES. To cut a hole that does not break through an edge, you need a keyhole, compass or coping saw. A keyhole saw has a slender tapered blade coming to a point. A compass saw is similar but slightly larger. A coping saw has a steel frame in which thin blades are clamped under tension.

After marking out the opening to be cut out, bore holes in two or more corners, big enough to admit the first two inches of the saw. Where the work cannot be turned, it may be well to bore a hole in each corner so that you can saw downward or in whatever direction is easiest.

If the opening is large, you can save time by starting the cut with a compass saw and then inserting a rip saw as soon as the kerf is long enough. The rounded corners left by the bored holes can be squared up with a saw or a rasp.

The keyhole saw is narrow enough to turn in the kerf, and will cut curves of reasonably large radius. But for sharp curves you'll need a coping saw. The limitation on a coping saw is the depth of its frame, for when this strikes the edge of the work, the blade can no longer cut (Figure 7).

The blade can be inserted with the teeth pointing toward or away from the handle, and it can also be turned at any angle to the frame. Take care to turn both blade holders to the same angle, keeping the blade flat, and to tighten the blade to full tension before starting to saw.

If an opening is to be cut entirely inside a piece, drill a small hole within the

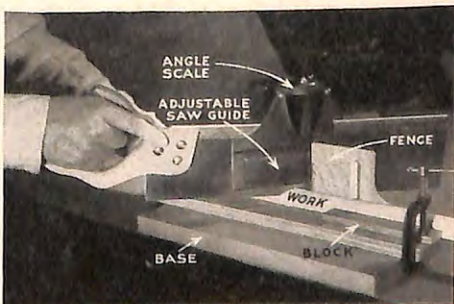

A backsaw and miter box are the right combination for accurate angle cutting. In this type of box, the saw guide is adjustable for both angle and height to suit various work thicknesses. To avoid sawing into the base, nail a piece of wood on top of it as shown. Hold work firmly against the fence or, if its shape makes this difficult, clamp a block against it as above.

waste area. Take the blade out of the coping saw, insert it through the hole, and then clamp it in the frame again, setting it at an angle that will allow you to saw without interference.

To cut with the work clamped upright in a vise, mount the blade with the teeth pointing away from the handle. The forward stroke will do the cutting. Be careful not to apply much down pressure, as the thin blades readily break.

Delicate or intricate work is best laid flat on a horizontal support such as a board clamped to the workbench top. The blade is inserted with the teeth pointing

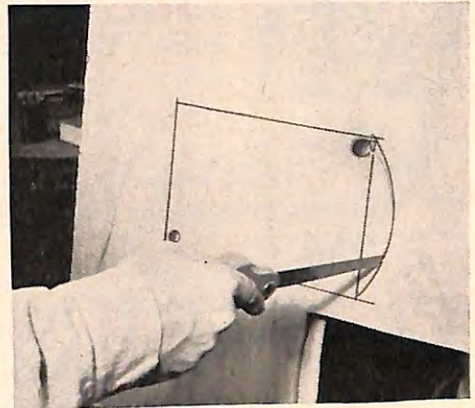

The keyhole saw can make fairly sharp curved cuts. Use short strokes and the narrow forward end of the blade when changing direction. Keep the downward pressure light so as not to kink or buckle the blade.

toward the handle, which is held underneath, with the saw vertical. This makes it cut on the down stroke. In order to follow intricate layouts, turn the work around the blade, keeping the saw in one position, instead of swinging it to change direction.

Multi-Million Dollar Business Now Being Split Up Among Home Operators in Small Communities

Inexpensive Table Top Machine Pays Profits UP TO \$9.20 AN HOUR

The multi-million dollar Rubber Stamp Business is now being taken over by small home operators throughout the U.S. Men and Women who operate this inexpensive machine can turn out large numbers of Rubber Stamps with special wording of all kinds. Only 27¢ worth of material makes a stamp that sells for \$1.80. The machine is easy for anyone to operate. It molds as many as six Rubber Stamps at a time, each with different wording such as names, addresses, notices, stock numbers, prices and other "copy" needed by offices, factories and individuals. At full capacity, it can earn as much as **\$9.20 an hour for the operator!** You don't need experience to get into this big profit business at home. We supply everything, including complete instructions and eight ways to get orders for stamps coming in fast. Start making up to \$9.20 in one hour right away. We'll mail full particulars FREE; no salesman will call. Be first in your locality. Rush coupon.

RUBBER STAMP DIV. 1512 Jarvis Avenue, Chicago 26, Ill.

RUBBER STAMP DIV., Dept. R-7-B
1512 Jarvis Ave., Chicago 26, Ill.

Please mail all facts showing how I can get started in the profitable Rubber Stamp business at home in spare time. Everything you mail me is FREE and no salesman will call.

NAME.....
ADDRESS.....
CITY..... Zone..... STATE.....

Editorial

ROWING AHEAD AND LOOKING ASTERN



This month we celebrate the 89th birthday of our Order.

Plutarch referred to "Watermen who look astern while they row the boat ahead". The Elk devotes himself faithfully to rowing the boat ahead but he will not make any less progress onward

as he looks astern.

Surely, in looking back over the years he finds inspiration for contributing to the future glory and accomplishments of the Order.

He sees a little group of fifteen men developing into a great brotherhood of 1,200,000 American citizens. He sees the assets of 1,800 lodges grow to a total of \$300,000,000 and notes that their donations to charitable, patriotic and civil activities have reached \$150,000,000.

There comes to him, as he looks astern, the story of the Elks National Foundation, developing from voluntary contributions a fund of \$6,000,000, not a dollar of which has ever been expended, the Grand Lodge paying all expenses.

He remembers that the income from the fund, approaching \$200,000 annually, is applied to providing scholarships for thousands of boys and girls and contributing to the welfare of thousands of crippled children and those suffering from such afflictions as cerebral palsy. To treat these children, Foundation donations are providing for the special training of doctors, nurses and therapists.

He notes with pride the contributions made to our government's assistance in the days of war. He recalls particularly in World War I the equipment of base hospitals at the battlefield in France, the erection of the first reconstruction hospital in this country and the providing of the funds which made it possible for the Salvation Army to carry on its magnificent work overseas.

In the vision of World War II he recalls the Order establishing 400 refresher schools to qualify young men for the Flying Cadet Corps and, at the request of the Adjutant General of the Army, enlisting 97,000 Ground Crew men for the Air Corps.

He recalls that the Adjutant General of the Army and the Chief of Naval Operations turned over entirely to the Order of Elks the enlistment of Army Engineers and Seabees, with resulting impressive success.

He pictures the fraternal centers established by the Order to provide for the comfort and conveniences of the young men entering the Services and the contributions made to the needs and morale in the entertainment of hospitalized veterans continued to this day under the direction of the Elks National Service Commission.

We cannot doubt that his looking astern will strengthen his interest in and service to the Order of which he is so proud to be a member.

THE FRATERNAL MAGAZINE— ITS "RAISON D'ETRE"



Webster's dictionary says that a fraternal order is a society organized for the pursuit of some common object, its members working together in a brotherly union and that a magazine is a periodical containing miscellaneous articles, poems, stories, etc. It follows

that a fraternal magazine is a magazine including printed matter to satisfy the particular interests of a special group striving jointly to accomplish certain goals.

However, there is more to a fraternal magazine than that. It properly is a stimulating document, capable of exciting and maintaining the interest of the members of the fraternity in its activities. It is a focal point to which the members can with interest and pride receive the news of the Order.

To develop and hold the interest of the readers of a fraternal magazine the Editors have to go one step further than merely furnishing news of the fraternity; beyond that, a true fraternal magazine reflects the general interest of the members. The Editors have to realize that it is necessary to give consideration in the written matter, advertising, art work and layouts to such broader interests as exist among the readers, in addition to their common interest in their organization. Thus, a magazine of this character is thoroughly representative of the fraternity and the class of audience that reads it.

A fraternal magazine is not designed primarily to be a money making proposition. Rather, there is a finer reason for its existence—service to the members of the organization responsible for its creation and publication.

A fraternal magazine must have the confidence of its subscribers since the latter properly have a feeling of ownership of the publication and responsibility for the soundness of its editorial and business policy and for the high character of the advertisements allowed to appear therein.

A fraternal publication has been referred to as primarily a vehicle to carry a member's fraternity into his home. It acts as a constant reminder to the members of the objectives of their fraternity and serves as a medium of education to the new member, bringing him quick appreciation of the overall pattern of his fraternity and encouraging him to work for its advancement.

Also a fraternal magazine serves as a watch dog of its association, ever alert to safeguard the interests of the fraternity from attack from without and ever watchful to maintain its dignity, high principles and traditions.

Through the excellence of its editorial contents the fraternal publication helps to keep the fraternity itself on a high plane and proves a constant stimulus to greater achievement.

NATURALLY—THE ELKS

When a family from South Carolina on its way to California for Christmas had an automobile breakdown in Georgia they appealed to the Augusta "Herald" for help. The Herald called for the assistance of ham radio operators to reach the Elks Clubs in the vicinity to get them to finance the trip, for they knew where to go. The Elk Lodges took over the job. Thus reports an Associated Press item of two days before Christmas.

FREE 30 DAYS SUPPLY VITAMINS

MINERALS and AMINO ACID Safe High Potency Nutritional Formula

25 proven ingredients—11 Vitamins (including Blood-building B₁₂ and Folic Acid), 11 Minerals, Choline, Inositol, and Methionine

NOW YOURS FREE



TO prove to you the remarkable advantages of the Vitasafe Plan . . . we will send you, without charge, a 30-day free supply of high-potency VITASAFE C. F. CAPSULES so you can discover for yourself how much healthier, happier and peppier you may feel after a few days' trial! Just one of these capsules each day supplies your body with over twice the minimum adult daily requirement of Vitamins A, C and D . . . five times the minimum adult daily requirement of Vitamin B-1 and the full concentration recommended by the National Research Council for the other four important vitamins! Each capsule contains the amazing Vitamin B-12—one of the most remarkably potent nutrients science has yet discovered—a vitamin that actually helps strengthen your blood and nourish your body organs by stimulating your bone marrow to produce more and more energy-bearing red corpuscles.

Why We Make This Sensational Offer!

We offer you this 30-day free trial of VITASAFE C. F. CAPSULES for just one simple reason. So many persons have already tried VITASAFE C. F. CAPSULES with such astounding results . . . so many people have already written in telling us how much better they felt after only a short trial . . . that we are convinced you, too, may experience the same feeling of health and well-being after a similar trial.

In fact, we're so convinced that we're willing to back up our convictions with our own money. You don't spend a penny for the vitamins! You don't risk a thing! All the cost and all the risk are ours!

In other words, we're willing to give you a full 30-day supply of our VITASAFE C. F. CAPSULES for you to prove to your own satisfaction your body's need for a comprehensive nutritional formula.

And here's just why we're so confident these capsules can help provide new vigor and buoyancy and zest for living!

Why YOU May Need These Safe High-Potency Capsules

As your own doctor will tell you, scientists have

discovered that not only is a daily minimum of vitamins and minerals, in one form or

another, absolutely indispensable for proper health . . . but some people actually need more than the average daily requirements established by the National Research Council. If you tire easily . . . if you work under pressure, or if you're over 40 or subject to the stress of travel, worry and other strains . . . then you may be one of the people who needs this extra supply of vitamins. In that case, VITASAFE C. F. CAPSULES may be "just what the doctor ordered"—because they contain the most frequently recommended food supplement formula for people in this category! These are safe high-potency capsules . . . and this nutritional formula has already helped thousands upon thousands of people who were run down, listless, and in need of just the help this formula can provide!

another, absolutely indispensable for proper health . . . but some people actually need more than the average daily requirements established by the National Research Council. If you tire easily . . . if you work under pressure, or if you're over 40 or subject to the stress of travel, worry and other strains . . . then you may be one of the people who needs this extra supply of vitamins. In that case, VITASAFE C. F. CAPSULES may be "just what the doctor ordered"—because they contain the most frequently recommended food supplement formula for people in this category! These are safe high-potency capsules . . . and this nutritional formula has already helped thousands upon thousands of people who were run down, listless, and in need of just the help this formula can provide!

Potency and Purity GUARANTEED!

In the column on the right you can see for yourself the exact ingredients contained in high potency VITASAFE C. F. CAPSULES. Every one of these ingredients has been scientifically added to meet the requirements of people in need of a high-potency nutritional formula. And, as you probably know, the U. S. Government strictly controls each vitamin manufacturer and requires the exact quantity of each vitamin and mineral to be clearly stated on the label.

This means that the purity of each ingredient, and the sanitary conditions of manufacture are carefully controlled for your protection! And it means that when you use VITASAFE C. F. CAPSULES you can

Retail Value \$5.00



Each Daily C. F. Capsule Contains:	
Vitamin A	12,500 USP Units
Vitamin D	1,000 USP Units
Vitamin C	75 mg.
Vitamin B ₁	5 mg.
Vitamin B ₂	2.5 mg.
Vitamin B ₆	0.5 mg.
Vitamin B ₁₂	1 mcg.
Niacin Amide	40 mg.
Calcium	75 mg.
Pantothenate	4 mg.
Vitamin E	2 I.U.
Folic Acid	0.5 mg.
Calcium	75 mg.
Phosphorus	58 mg.
Iron	30 mg.
Cobalt	0.04 mg.
Copper	0.45 mg.
Manganese	0.5 mg.
Molybdenum	0.1 mg.
Iodine	0.075 mg.
Potassium	2 mg.
Zinc	0.5 mg.
Magnesium	3 mg.
Choline Bitartrate	31.4 mg.
Inositol	15 mg.
dl-Methionine	10 mg.

Compare this formula with any other!

be sure you're getting exactly what the label states . . . and that you're getting pure ingredients whose beneficial effects have been proven time and time again! Not only that—you're getting a month's supply free of charge, so you can prove to yourself just how effective they may be for you! And now see what else you get—without the slightest risk on your part!

Amazing New Plan Slashes Vitamin Prices in Half!

With your free vitamins you will also receive complete details of an amazing new Plan that provides you regularly with all the vitamins and minerals you will need. By means of this Plan you can receive your vitamins and minerals factory-fresh, direct-to-you and at a saving of 60% off the regular retail price!

Always Factory Fresh

This means you will no longer have to go shopping around for vitamins or pay high retail prices. This Plan actually enables you to receive a 30-day supply of vitamins every month regularly, safely and factory-fresh for exactly \$2.00—or 60% lower than the usual retail price. BUT YOU DO NOT HAVE TO DECIDE NOW—you are under no obligation to buy anything from us whatsoever.

Now here's how you can get this Free 30-day supply, and learn all about this amazing new plan.

Act At Once!

Simply fill out the coupon and send it in to us today. We'll rush you your free month's supply of high potency VITASAFE C. F. CAPSULES along with information about the Plan. During your free trial period you can decide whether or not you want to enjoy the benefits and tremendous savings offered by the VITASAFE PLAN. In any case, the trial month's supply of 30 VITASAFE Capsules is yours to use free.

Now, since the supply of capsules that we can give away free is necessarily limited, we urge you to act at once. You risk nothing; the cost of the capsules is ours. So don't miss out on this marvelous opportunity. Fill in the coupon now and send it today.

Fill Out This No-Risk Coupon Today!



VITASAFE CORP. 43 West 61st Street, New York 23, N. Y.

VITASAFE CORP., Dept. 88-2
43 West 61st Street, New York 23, N. Y.

Please send me free a 30-day supply of the proven VITASAFE CF (Comprehensive Formula) Capsules, and full information about the VITASAFE plan. I am not under any obligation to buy any additional vitamins, and after trying my free sample supply, I may accept the benefits and substantial savings offered by the VITASAFE Plan, or if not fully satisfied will reject them. In any case, the trial month's supply of 30 VITASAFE Capsules is mine to use free.

I ENCLOSE 25¢ (coins or stamps) to help pay for packing and postage.

Name.....

Address.....

City..... Zone..... State.....

This offer is limited to those who have never before taken advantage of this generous trial. Only one trial supply per family.



WINSTON
TASTES GOOD!

LIKE A
CIGARETTE
SHOULD!



Taste is what folks talk about
— *and like about* **WINSTON**

People keep saying how really good Winstons taste! And... how the exclusive Winston filter—*snowy-white and pure*—lets that rich flavor come through! If you haven't tried today's most talked-about flavor-filter combination, latch onto a pack of Winstons right now—for flavory filter smoking!

R. J. REYNOLDS TOBACCO CO., WINSTON-SALEM, N.C.

Smoke **WINSTON** America's best-selling, best-tasting filter cigarette!