

THE
Elks
MAGAZINE

THE U. N.
AND THE SOVIET

By Senator William F. Knowland

MARCH 1957

E



**GENUINE
Black Forest
HUNTING KNIFE**

**NOW
ONLY**

99c

**OVER 100,000
SOLD FOR
\$3.95**

- Rugged Korium Steel
- Sharp Enough to Shave With
- Lifetime of Service

This is the famous, the original Black Forest—the world's most popular hunting knife. Its rugged beauty has won recognition for design throughout Europe & America. Hand-forged by old world steelsmiths famed for their high standards of workmanship. Precision-tempered high carbon steel—*sharp enough to shave with!*

Use the Black Forest on every hunting, fishing and outdoor trip you take. Use it to skin moose, rabbit, deer, bear, etc. To cut hemp, rope, branches, etc. To hunt small game—it makes a silent, accurate weapon. Use it to dig holes when shovel can't penetrate frost-hardened ground. Use it in a hunting emergency—*when seconds really count!* No matter how, when or where you use the Black Forest, it will come through for you like a true champion!

Use the Black Forest at home, too, for carving turkey, roasts, etc. It even makes a handsome wall decoration. Over 100,000 sportsmen paid \$3.95 for their knives. Now—for a limited time—we SLASH that price way down to only 99c plus 21c for the leather sheath. Total price: \$1.20. This is one bargain you can't afford to pass up. But hurry—this is a temporary price reduction.

No. 76\$1.20

NOTE TO READER: We guarantee every item to be brand-new, first-quality. Mail coupon for 10-Day trial.

**DURABLE
LEATHER SHEATH**

**THIS
PHOTO IS
ACTUAL
SIZE OF
KNIFE**

**10 INCHES
OVER ALL**

**Known All Over
the World!**

**Extra Fine Point
for Faster Cutting!**

**NEW... HI-POWER All-Purpose
Professional Paint Sprayer!**



NOT \$29.95

OUR PRICE

9⁹⁵

Save 66%

**SAVE TIME!
SAVE LABOR!
SAVE MONEY!**

Complete Kit—no extras to buy!

Thoresen's greatest discount bargain in the last 10 years! Now... don't pay \$29.95 for a professional all-purpose, fully automatic Spray Gun. Our cash price only \$9.95. You save 66%—a full \$20! This amazing bargain is made possible because of a special deal with the manufacturer of this nationally famous Hi-Power automatic Sprayer.

**CUTS PAINTING TIME 75%
SAVES YOU HUNDREDS OF DOLLARS!**

Why pay professional painters \$20 to \$50 a room? With this Sprayer you turn out quality jobs for mere pennies!

THROW AWAY THOSE SLOPPY PAINT BRUSHES!

No more backaches! No more brush cleaning! Just plug in this Hi-Power Spray Gun. Press the button and paint automatically. You'll turn out a clean satin-smooth job the very first time! No streaks! No dripping! No brush marks! Reaches corners, deep cracks, rough and pebble surfaces... far easier than a brush. **ONE-THOUSAND-AND-ONE USES!**

Use it around the house, shop, garden, garage. Use it to paint walls, ceilings, floors, stairs, chairs, furniture, screens, garden tools, garage doors, boats, toys, etc. Use it to spray insecticides on flowers, plants, shrubs! Use it to exterminate flies and mosquitoes... to mothproof clothes... to touch-up scratches on auto fenders—even to lubricate under the chassis! This powerful Spray Gun takes paint, enamels, lacquers, varnishes, shellacs, insecticides, disinfectants, polishes, deodorants, fungicides, agents, liquid fertilizers, light oils, water, etc. Needs no tank or air compressor. Has built-in strainer—cannot clog or drip—cleans itself in seconds—cannot break in use—it's absolutely safe! Built to last a lifetime and doubly guaranteed by its famous manufacturer and by Thoresen's. Limit one per customer at this rock bottom price.
No. 102\$9.95



**GERMAN
PRECISION**

AUTOMATIC

**.22 BLANK PISTOL
\$15.00 VALUE**

\$6⁹⁵

For fun, sports, protection against prowlers, Precision-made in highest traditions of German guncraft. Exact model of death-dealing automatic! Uses only .22 cal. harmless blanks. Chamber gives off terrific percussion audible at enormous distances—enough to frighten the daylights out of any "character" hundreds of feet away! 6 shot fully automatic magazine. Safety catch. Self-ejecting clip. Carbon steel construction. DeLuxe Cordovan handle. 4 inches long. No permit needed. Can be shipped anywhere (except in N. Y. State). \$15.00 value—yours for only \$6.95 while supply lasts! New shipment from Germany will cost dollars more!
No. 111—\$6.95

**THORESEN, Inc., Dept. 103-C
585 Water Street, New York 2, N. Y.**

RUSH the items checked below. My money back promptly if not satisfied.

- Check, cash, money order enclosed. Send prepaid.
- Send C.O.D., plus postal charges.
- No. 76 Black Forest & Sheath...\$1.20
- No. 102 Hi-Power Paint Sprayer... 9.95
- No. 111 German Automatic Pistol.. 6.95

Name.....

Address.....

City &

Zone.....State.....

Canadians: Address 45 St. James St., W., Montreal 1, P. Q.

Your vote is in and these five win!

THE NEWEST NEW CARS IN 20 YEARS

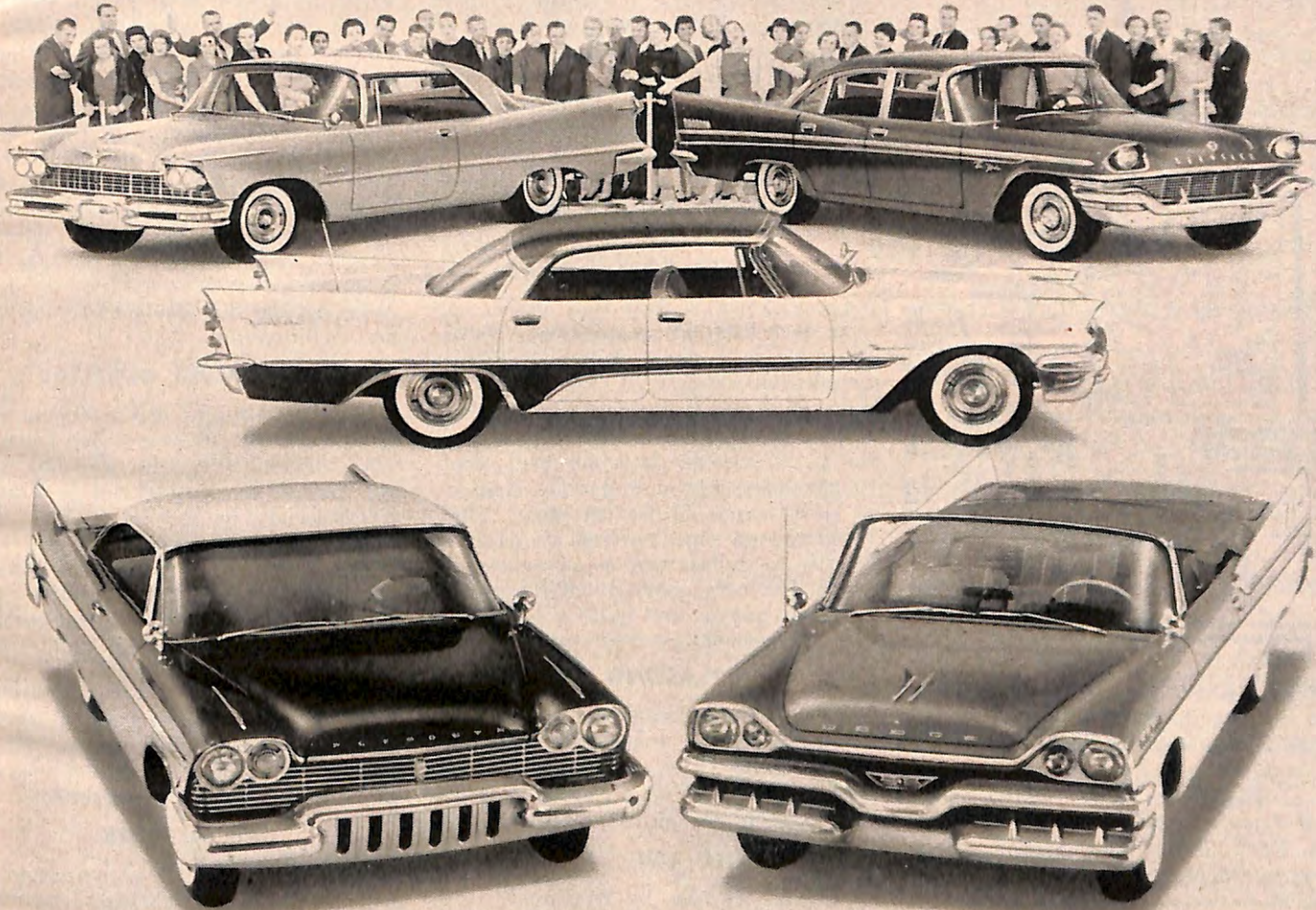

In left foreground, Plymouth; right, Dodge; center, De Soto; rear left, Imperial and rear right, Chrysler. With a total of 93 models to cover all price ranges—with over 400 color combinations to choose from, there's a Chrysler Corporation car that's right for you!

You and your neighbors are giving these 5 cars the most thunderous reception in automotive history. For here is genuinely new leadership in styling and engineering—to give you a whole new concept of driving pleasure!

COMPARE THE STYLE! In seeing these cars you recognized The New Shape of Motion as not simply warmed-over styling but a brilliant new concept in design. Here, in America's lowest, roomiest cars is the clean, uncluttered beauty that won instant acclaim. Other cars are reaching toward this styling—these cars have it *now!*

COMPARE THE RIDE! In revolutionary new Torsion-Aire, you discovered that Chrysler Corporation engineers have achieved the first major, across-the-board suspension advance in 33 years. You found that with Torsion-Aire, the car virtually planes away all road roughness, takes tight turns without lean, stops without dive.

COMPARE THE VALUE! With new Pushbutton TorqueFlite transmission offering unmatched smoothness and surge . . . new Total-Contact Brakes that put *less* toe pressure to *greater* effect . . . exclusive Full-Time power steering . . . everyone agrees these cars have road wizardry all their own! If you haven't driven one—do so, *soon!*

CHRYSLER CORPORATION ➤ **THE FORWARD LOOK**

PLYMOUTH • DODGE • DESOTO • CHRYSLER • IMPERIAL



Tom Wrigley Writes from WASHINGTON



CONGRESS is at work trying to whittle down the \$71,800,000,000 federal budget for the next fiscal year beginning July 1 and is finding a lot of tough knots. One of the biggest is the public debt. Uncle Sam is in the red to the tune of about \$275 billion. The annual interest rate on the debt, which will be higher, is about \$7 billion a year. That means \$41 cash a year from every individual in the country. The budget is the highest peace time bill in history. The only ray of sunshine on it is an estimate that, with good times, revenues will be a billion or more above the staggering cost of government and thus permit a reduction in the debt. There is no thought of lower taxes. Some legislators doubt there will be any surplus at all. Where does all the money go? There are big boosts in national defense, in welfare costs, in foreign economic aid, in nuclear research. The cost of running the government also is higher than ever. Efforts to substantially slash the number of workers have failed. There are more than 7 million persons on the government payroll and more partitions are being built in the giant Pentagon here to accommodate more workers.

SHOOTING FOR RAIN

Our Air Force pilots and gunners may go hunting for rain if the bill of Senator

Case of S. D. becomes law. Last summer, National Guard airmen in that state seeded likely looking clouds with dry ice seven times and produced rain seven times. One shot brought down a 3-inch soaking. Senator Case says the clouds which might let go with rain are extremely high and move so fast that only a jet plane can get above them and catch them. They are located by radar. Cumulus clouds 500 or more feet above the freezing line and with a temperature at the top of minus 10 degrees centigrade can be seeded with dry ice or silver iodide and rain will result. It also is believed that cloud seeding would prevent hail and lightning storms by busting them into rain.

JUNKETS COST MONEY

Congressmen in their trips abroad last year spent \$490,236 in counterpart funds, according to a report just made public. Countries receiving U. S. economic aid are required to match the funds with currency of their own, part of which is deposited to the U. S. account. It is the fund which Congressmen draw on in part for expenses in their travels to foreign lands. Most Congressional trips, however, are paid for directly in dollars and no accounting is made. The last Congress voted \$11 million for investigations and quite a bit of the money was spent in overseas probes.

EVERLASTING TILE

A Philadelphia firm advertised a plastic tile which it said would not wear out. Federal Trade Commission in effect said there isn't any such thing and the company has agreed to change its advertising.

PARKING LOT GADGET

Shopping centers in Washington are planning to install new gadgets to stop moochers from using their lots for free auto parking. One new idea has gates at entrances which open after a quarter is dropped in a slot. A ticket comes out with the time punched on it and a loud speaker tells the driver just where there is space to park. The ticket is redeemed in any store in the center. Gates with electric eyes open as cars leave the exits. It's all mechanical and no attendant is needed.

PUT MELLON ON YOUR LIST

Visitors to Washington should be sure to include the National Gallery of Art on their schedule. This great gift of Andrew W. Mellon is truly an inspiration. Each week there is a guided tour for visitors. Dr. Raymond S. Stiles, educational curator, says over 80,000 people visited the gallery last year. The total may reach 100,000 this year. Some 500 persons, he says, are "regulars". They come every week. FBI men also come in frequently

for lunch and a looksee. Most controversial painting is surrealist Salvador Dali's "Last Supper," both praised and damned. It is on loan to the gallery.

MUTTON FOR A KING

Blair House, opposite the White House, where King Saud II of Arabia stayed recently, had plenty of mutton which was prepared native style. It was not necessary, however, to have sheep grazing on the White House lawn, but the visit brought back memories of King Saud's late father, Ibn Saud, and the meeting with President Roosevelt in 1945. The U. S. destroyer in the Suez Canal, where the conference took place, had a dozen or more live sheep corralled on the rear deck to supply the royal party. They say in the Navy that the ship smelled like a lanolin factory for months.

TEEN-AGERS HOSPITAL

Children's Hospital in Washington, with a falling off in polio cases, has come up with something new to use a vacant ward. One floor of the hospital has been made over especially for teen-age patients. The pictures of bunnies and flowers and birds on the walls have been removed and the furnishings are just what teen-agers want. The only thing they lack are telephones to gab by the hour. The ward is exclusively for the 12-18 age group, one section for boys and the other for girls. The young patients sign their own hospital records and are not treated like babies. At the same time they are not in adult hospital with chronically ill or dying patients.

CAPITAL CUTS

Civil Defense says 800 planes would be available for airlift in case of national emergency . . . Jet engine noises are making a lot of Air Force ground men deaf and the Veterans Administration is now spending \$60 million a year in deaf veteran benefits . . . Riggs National Bank made \$43.45 a share last year, highest in history . . . New car sales in D. C. are lagging . . . Atomic Energy Commission will move to Germantown, Md., late this year and is recruiting 500 clerical employees who will live nearby . . . Residential street parking here has an 18-hour limit but the regulation is seldom enforced and motorists are demanding it be changed, saying it is silly to keep moving their cars around . . . Washington motorcycle police are going to wear crash helmets in order to cut down injuries . . . Serious crime here declined 9.2 per cent in the last year . . . Jewish Population of Greater Washington is between 80,000 and 90,000, the Jewish Community Council reports . . . The WAC's are going to have new uniforms of green.

Will Your Next Vacation Really Be Something to Remember?

The surest way to guarantee a new, different, and exciting vacation is to learn the hundreds of things you can do and the places you can visit on the money you want to spend.

Norman Ford, founder of the world-known Globe Trotters Club, tells you that in his book, *Where to Vacation on a Shoestring*. This is the man who has spent a lifetime searching for ways to get more for your money in vacations and travel.

In his book, you learn

- about low-cost summer paradises, farm vacations, vacations on far-off islands, on boats, drifting down lazy streams while you fish.
- about vacations at world-famous beaches, under palm and eucalyptus trees, in government-subsidized vacation resorts, in Indian country, along rugged coastlines, on ships and by rail.
- about dude ranches you can afford, what to see, do, and how to save at national parks and in the cities most Americans want to visit.

-about low-cost sailing ship cruises, houseboat vacations in the North Woods, fantastically low-cost mountain vacations, the unknown vacation wonderlands almost at your front door.

How to stop saying—

"I Always Spend Too Much On My Vacation"

Of course, Norman Ford knows where to get real vacation bargains in all America, from Maine to California, and in Canada, Mexico, etc. At no time does he ask you to spend a lot of money to enjoy yourself, no matter how really different and exciting is the vacation you choose through his experienced advice. Always, he tells you the many things you can do within your budget and how to get more for your money (if you travel by car, he shows how most auto parties can save \$6 or \$7 a day).

You can't help but learn something that is just meant for you. Yet, *Where to Vacation on a Shoestring* costs only \$1. To make sure your next vacation will be something to talk about, get the facts now. Use the coupon to order.

'Round the World on a Shoestring

If you know the seldom-advertised ways of reaching foreign countries, you don't need fantastic sums of money in order to travel. You could spend \$500-\$1000 on a one-way luxury steamer to Buenos Aires—but do you know you can travel all the way to Argentina through colorful Mexico, the Andes, Peru, etc. by bus and rail for just \$109 in fares?

You can spend \$5000 on a luxury cruise around the world. But do you know you can travel around the world via deluxe freighter for only a fourth the cost and that there are a dozen other round the world routings for under \$1000?

There are two ways to travel—like a tourist, who spends a lot, or like a traveler, who knows all the ways to reach his destination economically, comfortably, and while seeing the most.

Norman Ford's big new guide, *How to Travel Without Being Rich*, gives you the traveler's picture of the world, showing you the lower cost, comfortable ways to practically any part of the world. Page after page reveals the ship, rail, bus, airplane and other routings that save you money and open the world to you.

What do you want to do? Explore the West Indies? This is the guide that tells you how to see them like an old time resident who knows all the tricks of how to make one dollar do the work of two. Visit Mexico? This is the guide that tells you the low cost ways of reaching the sights (how 56¢ takes you via 8-passenger automobile as far as those not-in-the-know pay \$5.60 to reach). Roam around South America? Europe? Any other part of the world? This is the guide that tells you where and how to go at prices you can really afford.

If you've ever wanted to travel, prove now, once and for all, that travel is within your reach. Send now for *How to Travel Without Being Rich*. It's a big book, with over 75,000 words, filled with facts, prices and routings, and it's yours for only \$1.50. Even one little hint can save you this sum several times over.

Passenger-carrying FREIGHTERS are the secret of low-cost travel

Yes, for no more than you'd spend at a resort, you can take a never-to-be-forgotten cruise to Rio and Buenos Aires. Or through the West Indies or along the St. Lawrence River to French Canada. In fact, trips to almost everywhere are within your means.

And what accommodations you get: large rooms with beds (not bunks), probably a private bath, lots of good food and plenty of relaxation as you speed from port to port.

Depending upon how fast you want to go, a round the world cruise can be yours for as little as \$250-\$300 a month. And there are shorter trips. Fast, uncrowded voyages to England, France, the Mediterranean; two or three vacations up and down the Pacific Coast or to New Orleans. Name the port and the chances are you can find it listed in *Travel Routes Around the World*. This is the book that names the lines, tells where they go, how much they charge, briefly describes accommodations. Hundreds of thousands of travelers all over the world swear by it. Travel editors and travel writers say "To learn how to travel for as little as you'd spend at a resort get *Travel Routes Around the World*."

It's yours for just \$1, and this fact-filled 131-page book includes practically every passenger-carrying service starting from or going to New York, Canada, New Orleans, the Pacific Coast, Mexico, South America, England, France, the Mediterranean, Africa, the Indies, Australia, the South Seas, Japan, Hawaii, etc. There's a whole section called "How to See the World at Low Cost," plus pages and pages of photos and maps.

A big \$1 worth, especially as it can open the way to more travel than you ever thought possible. For your copy, simply fill out coupon.

WHERE WILL YOU GO IN FLORIDA?

IF YOU WANT A VACATION YOU CAN AFFORD

Florida needn't be expensive—not if you know just where to go for whatever you seek in Florida. And if there's any man who can give you the facts you want it's Norman Ford, founder of the world-famous Globe Trotters Club. (Yes, Florida is his home whenever he isn't traveling!)

His big book, *Norman Ford's Florida*, tells you, first of all, road by road, mile by mile, everything you'll find in Florida, whether you're on vacation, or looking over job, business, real estate, or retirement prospects.

Always, he names the hotels, motels, and restaurants where you can stop for the best accommodations and meals at the price you want to pay. For that longer vacation, if you let Norman Ford guide you, you'll find a real "paradise"—just the spot which has everything you want.

Of course, there's much more to this big book.

IF YOU WANT A JOB OR A HOME IN FLORIDA

Norman Ford tells you just where to head. His talks with hundreds of personnel managers, business men, real estate operators, state officials, etc., let him pinpoint the towns you want to know about if you're going to Florida for a home, a job with a future, or a business of your own. If you've ever wanted to run a tourist court or own an orange grove, he tells you today's inside story of these popular investments.

IF YOU WANT TO RETIRE ON A SMALL INCOME

Norman Ford tells you exactly where you can retire now on the money you've got, whether it's a little or a lot. (If you need a part-time or seasonal job to help out your income, he tells you where to pick up extra income.) Because Norman Ford always tells you where life in Florida is pleasantest on a small income, he can help you take life easy now.

Yes, no matter what you seek in Florida—whether you want to retire, vacation, get a job, buy a home, or start a business, *Norman Ford's Florida* gives you the facts you need to find exactly what you want. Yet this big book with plenty of maps and well over 100,000 words sells for only \$2—only a fraction of the money you'd spend needlessly if you went to Florida blind.

For your copy fill out coupon below.



Fill Out and Send at Once
for Quick Delivery

Mail to HARIAN PUBLICATIONS 153 Spring St.
Greenlawn (Long Island), New York

I have enclosed \$..... (cash, check, or money order). Please send me the books checked below. You will refund my money if I am not satisfied.

- Where to Vacation on a Shoestring. \$1.
- Norman Ford's Florida. \$2.
- How to Travel Without Being Rich. \$1.50.
- Travel Routes Around the World. \$1.
- Special Offer: All books above for \$5.

Name.....

Address.....

City and State.....

**Enough coverage
is important!**



NEW YORK LIFE'S EMPLOYEE PROTECTION PLAN

designed for firms
with 5 or more employees

... gives employer
and employee
these modern
3-way benefits:

①

Life Insurance

Payable at death to beneficiary. Accidental death benefit optional.

②

Weekly Indemnity Benefit

Payable for total disability due to non-occupational accident or sickness. Different amounts and benefit periods available.

③

Medical Care Benefits

To help meet hospital, medical and surgical expenses due to non-occupational accident or sickness. Several benefit schedules available for insured employees and their dependents.

Ask your New York Life agent for information now, or write to address below.

Individual policies or a group contract may be available, depending upon number of employees and applicable state law.

NEW YORK LIFE INSURANCE COMPANY

51 Madison Avenue, New York 10, N. Y.

A Mutual Company  Founded in 1845

The New York Life Agent in
Your Community is a Good Man to Know

THE Elks MAGAZINE

VOL. 35

MAGAZINE

No. 10

NATIONAL PUBLICATION OF THE BENEVOLENT AND PROTECTIVE ORDER OF ELKS OF THE UNITED STATES OF AMERICA. PUBLISHED UNDER THE DIRECTION OF THE GRAND LODGE BY THE NATIONAL MEMORIAL AND PUBLICATION COMMISSION.

THE ELKS NATIONAL MEMORIAL AND PUBLICATION COMMISSION

JOHN S. McCLELLAND
Chairman

EMMETT T. ANDERSON
Vice-Chairman

JAMES T. HALLINAN
Treasurer

WADE H. KEPNER
Secretary

JAMES R. NICHOLSON
General Manager

LEE C. HICKEY
Editor

REGINA M. FISHER
Associate Editor

JOSEPH C. JONES
Art Editor

GENEVIEVE G. CONOVER
Advertising Production

W. H. MAGRATH
Controller

JOHN SCHMITT
Circulation Manager

EDWARD FAUST
Promotion Manager

EDITORIAL OFFICES, 386 Fourth Avenue, New York 16, N. Y.

CONTENTS FOR MARCH, 1957

COVER BY JOHN McDERMOTT

TOM WRIGLEY WRITES FROM WASHINGTON.....	2
WHAT OUR READERS HAVE TO SAY.....	5
A MESSAGE FROM THE GRAND EXALTED RULER.....	6
ELKS NATIONAL FOUNDATION—"The Joy of Giving.".....	7
SOVIET AGGRESSION.....	8
WARRIOR'S RETURN.....	10
"TO OUR ABSENT BROTHERS".....	12
GOOD PITCHERS TAKE CHARGE.....	14
ACROSS THE COUNTRY WITH YOUR SERVICE COMMISSION.....	16
LODGE VISITS OF FRED L. BOHN.....	17
NEWS OF THE LODGES.....	18
REPORT ON RUSSIA.....	21
FOR ELKS WHO TRAVEL.....	22
IN THE DOGHOUSE.....	24
ELKS FAMILY SHOPPER.....	28
GRAND LODGE CONVENTION PROCLAMATION.....	36
TRAVELGUIDE.....	38
ROD AND GUN.....	40
GRAND EXALTED RULER BOHN'S YOUTH DAY PROCLAMATION.....	41
ELKS WORKSHOP.....	54
EDITORIAL.....	56



ADVERTISING OFFICES



CHICAGO 1
360 North Michigan Avenue
STATE 2-6662

NEW YORK 16
386 Fourth Avenue
MURRAY HILL 4-5495

LOS ANGELES 17
1709 West 8th Street
DUNKIRK 8-5187

SAN FRANCISCO 4
927 Mills Building
EXBROOK 2-4073

PORTLAND 4, ORE.
217 Times Building
CAPITOL 7-3718

CHANGE OF ADDRESS: POSTMASTER—Please mail Form 3579 notices to: THE ELKS MAGAZINE
386 Fourth Avenue, New York 16, N. Y.

Members are asked, in changing address, to send this information (1) Name; (2) Lodge number; (3) Membership number; (4) New address; (5) Old address. Please allow 30 days for a change of address to be effected. THE ELKS MAGAZINE, Volume 35, No. 10, March, 1957. Published monthly at McCall Street, Dayton, Ohio by the Benevolent and Protective Order of Elks of the United States of America. Entered as second class matter November 2, 1940, at the Post Office at Dayton, Ohio, under the Act of August 24, 1912. Acceptance for mailing at special rate of postage provided for in Section 1103, Act of October 3, 1917, authorized May 20, 1922. Printed in Dayton, Ohio, U.S.A. Single copy price, 20 cents. Subscription price in the United States and its Possessions, for Elks \$1.00 a year; for non-Elks, \$2.00 a year; for Canadian postage, add 50 cents a year; for foreign postage, add \$1.00 a year. Subscriptions are payable in advance. Manuscripts must be typewritten and accompanied by sufficient postage for their return via first class mail. They will be handled with care but this Magazine assumes no responsibility for their safety. Copyright, 1957, by the Benevolent and Protective Order of Elks of the United States of America

What Our Readers

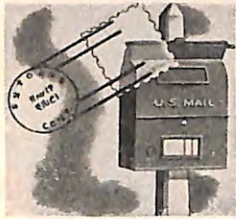

Have to Say

Congratulations on the timely, pithy editorial, "Nationalism Cannot be Halted", in your January issue. Certainly, we in the Free World—as well as the oppressed ones behind the Iron Curtain—want to see the dissolution of Russia's Communist Empire. And evidence that Nationalism is "on the march" justifies belief that Communist aggression is on the way out.

I was intensely interested in the evidence presented in the article "Satellite Struggle for Freedom" by Bruno Shaw in the same issue. The material which Mr. Shaw obtained direct from underground agencies—tied to what we know about the defiance of their Communist masters by the brave Hungarian people—gives a hopeful slant to a situation that has seemed hopeless.

Yet, our welcoming of the evidence that "Slovakia's underground makes long-range plans to oust the Soviets" is not enough. We Americans, through our understanding, prayers, and spiritual support, must do our part.

Ada Lillian Bush

Washington, D. C.

May I express my heartfelt thanks for your splendid article "Satellite Struggle for Freedom" by Bruno Shaw.

It reflects the efforts of groups such as the National Committee for the Liberation of Slovakia in seeing that the rights of small states are respected. I sincerely hope further articles will be forthcoming.

Stephen J. Pitoniak

Westfield, Mass.

I extend to you my congratulations on the editorial in the December 1956 issue of *The Elks Magazine*, headed "The Generous Spirit of Elksdom" plus "A Proclamation", which impressed me greatly and which I feel were outstanding.

With every good wish for the New Year, I am

Michael J. Harper

Brooklyn, N. Y.

The Elks Magazine reciprocates Brother Harper's best wishes and is most appreciative of his comments about the magazine.

Thank you very much for the 1,000 copies of your January issue, which had the feature article on the Navy Band. They arrived in our office on January 10th and many have already been sent out to our tour-territory.

Again, may we thank you for this courtesy extended the World Famous United States Navy Band.

Gib Sandefer, Tour Director
Washington, D. C.

FOR THE NEXT 30 DAYS ONLY—
THIS VERY SPECIAL
'SEEING IS BELIEVING' OFFER
TO INTRODUCE YOU TO AMERICA'S MOST BEAUTIFUL,
MOST EXCITING NEW PUBLICATION

AMERICAN HERITAGE

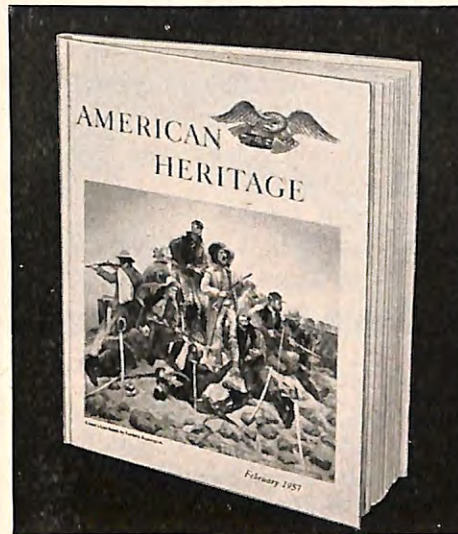

ONE
TRIAL
ISSUE
FOR ONLY

\$1

REGULAR
PRICE: \$2.95

EDITOR: Bruce Catton,
1954 Pulitzer Prize Winner

SPONSORS: The Society of
American Historians and The American
Association for State and Local History

DISCOVER THE TREASURES OF THE AMERICAN PAST. Now, for just *one dollar*, you can introduce yourself to the pictorial splendor and magnificent writing of America's most widely praised new publication—**AMERICAN HERITAGE**—your gateway to the treasures of the American past . . . to your understanding of America's present and future.

WHAT AMERICAN HERITAGE IS. 6 times a year, the history of the United States comes to life in rich, vivid, *true* detail . . . in the pages of this extraordinary publication. Here you find not only the lives, the intimate secrets, the carefully concealed scandals of the "great," but thousands of revealing glances of people like yourself living and working and playing and fighting, if need be—to build *your* heritage. Every issue is a fine 112 page book for permanent enjoyment . . . a big 8½ x 11", case-bound between beautiful, durable board covers. Every issue is also a fine magazine . . . containing 14 varied articles by top writers and 25 or more full color pages of old prints, maps, photographs, art treasures, and unusual Americana . . . with no advertising to intrude.

WHY THIS SAMPLE OFFER? We are offering this trial copy of **AMERICAN HERITAGE** for just one dollar (\$1.95 less than you would pay in any bookstore), because we are confident that once you have experienced it—visually . . . intellectually . . . *emotionally*—you will want to become a regular subscriber. We're betting you'll like it—but we're not plunging over our heads, any more than you will be. We are limiting this offer to the next 30 days only! So, mail the coupon below with your dollar today.

P. S. As an added inducement for you to subscribe, we will send you an interesting proposal—an *extra* subscription offer—along with your trial copy. Your \$1 trial does not, however, obligate you in any way!

CRITICS ACCLAIM AMERICAN HERITAGE

Time Magazine: "A rich blend of good story-telling, vivid historical fact and fine color pictures."

Sterling North, Scripps-Howard Newspapers: "Exactly the sort of publication we need to renew our faith in America. One of the most important truth-telling, morale-building publishing projects in many years."

Paul Engle, Chicago Tribune: "AMERICAN HERITAGE continues brilliantly to surpass all other publications dealing with history. It has a greater range and variety of subject . . . and more superb use of color in illustration."

J. Donald Adams, N. Y. Times: "AMERICAN HERITAGE is by all odds my favorite magazine. I find in it more to interest me, more attractively presented, than I find in the pages of any other periodical."

Carl Victor Little, The Houston Press: "Although AMERICAN HERITAGE sells for \$2.95, it is apparent that \$10 or \$12.50, considering the color plates, the text and the general production job, would be a reasonable price. If you can't buy, beg or borrow AMERICAN HERITAGE, then steal a copy—but not mine."

OFFER GOOD FOR 30 DAYS ONLY • MAIL COUPON TODAY!

AMERICAN HERITAGE, Dept. 6501, 551 Fifth Ave., New York 17

I am enclosing one dollar (\$1) in cash check money order, for my introductory issue of **AMERICAN HERITAGE**. I will also receive an *extra* bonus subscription offer which I am at complete liberty to accept or reject. I understand that the introductory issue is mine to keep, whether I take advantage of the extra bonus offer or not.

Name.....

Address.....

City.....Zone.....

State.....

"DEVELOP ELKDOM'S RESOURCES"

AMERICA was founded by staunch and sturdy individuals with broad vision who dared the elements and jibes of friends to discover this new land. They were the leaders of an expedition destined to change the course of history.

America has always been a nation of leaders and today we enjoy the results of these early efforts. This position of leadership also poses a severe responsibility, for we must recognize our moral obligations to our fellow nations.

So it is in the Order of Elks.

During the month of March the Exalted Rulers of 1,800 Lodges are concluding their terms. They are the leaders on whom 1,200,000 American gentlemen pinned their faith a year ago in the hope of continuing progress. They are the men we are asking all Lodges to honor this month with special classes of selective members.

Most of them have done excellent jobs and we are grateful for their efforts. Some of them have been "buggy riders" and lived out their terms just to be recognized as Past Exalted Rulers, but all of them assumed the same obligations and are Elks at heart.

This is the month when proof of their leadership will be written into the records. This is the month when any mistakes of the past can be rectified and converted into golden accomplishments. This truly is one of the greatest months of opportunity in Elkdom.

Growth is dependent on leadership and I am happy that most of our Lodges have enjoyed good leadership. I hope they will be equally selective when they nominate new officers.

Incidentally, one of the nicest presents a retiring Exalted Ruler could give his successor would be an increased membership with no delinquents in dues.

So to the retiring officers, I extend my thanks for your devotion to the Order which I feel will continue on through the years.

May your accomplishments of the past be our inspirations for the future.

With deep gratitude and warm personal regards, I am

Very sincerely,



GRAND EXALTED RULER



A Message from the Grand Exalted Ruler

"A STRONGER ELKDOM FOR A BETTER AMERICA"

ELKS NATIONAL FOUNDATION



"The Joy of Giving"

George "Sonny" Hayes, 18 years old, has been crippled since birth but with the help of the Elks National Foundation was accepted as a student at Boston University under a Hospital and Tutorial Program which will enable him to take a full curriculum.

While "Sonny" is confined to a wheelchair, he receives his lessons and lectures via a recording machine. He also has the books required for the various subjects. One day a week George is taken by his father to the University, where he has the opportunity of consulting with his professors. The cost of this special course of instruction is being underwritten by the Elks National Foundation and Quincy, Mass., Lodge.

In the accompanying photograph, Sonny is adjusting his recording machine as Past Exalted Ruler Joseph E. Brett, left, and Exalted Ruler Anthony M. Cardarell of Quincy Lodge watch the procedure.

Your contributions to the Elks National Foundation are actively at work in the interest of humanity.

Past Grand Exalted Ruler John F. Malley, Chairman of the Elks National Foundation, recently prepared a most interesting booklet under the title "The Privilege and Joy of Voluntary Giving". This excerpt from the booklet thoroughly expresses the spirit underlying the Foundation:

"We are members of the world's greatest fraternity, which extends to us the privilege of participation in a broad program of philanthropy. The possibilities of the Foundation in this field of good works are limitless. They can be bounded and circumscribed only by the members themselves. All things that are being done at the present time have been made possible by the participation of the few who have carried the torch. When you realize what has been done, then you can form your own judgment of the magnificence of the future, the tremendous possibilities which are attainable if you join with others and



give generously in your contributions to the Foundation, and build up the principal fund to what it should be."

Recently, Chairman Malley made a survey to ascertain what is being done by the students helped by the Elks National Foundation under the cerebral palsy program. "It was pleasing to know," Mr. Malley says, "that substantially all of them are working in the field of cerebral palsy". Replies were so interesting and revealing that they will be quoted from month to month in the "Joy of Giving" column.

Mrs. Aileen A. Weiss of Spartanburg, S. C., who is employed as a Speech Therapist, advises Mr. Malley, "We have opened a school for cerebral palsy youngsters in this area and hope to enlarge it in the near future. The training I received through the Foundation has helped me a great deal in organizing our local program for the cerebral palsy children and also in administering a therapeutic program."

News arrives that Miss Sachi Kuratomi, of Los Angeles, has been awarded an Elks National Foundation Fellowship for a course in physical therapy at the Children's Hospital Society of that city. Miss Kuratomi is sponsored by Los Angeles Lodge. She attended the University of California for three years, majoring in Physical Therapy.

Miss Eleanor J. Hobbs, Newton Highlands, Mass., is the recipient of a \$750 Foundation fellowship for advanced training in cerebral palsy to enable her to complete her senior year at the Boston School of Occupational Therapy. Miss Hobbs was sponsored by Newton Lodge.

GOING?

**B.P.O. ELKS
Grand Lodge
Convention**

**San Francisco
July 14-18**

FLY THERE

on United. Fast, comfortable. Arrive relaxed and ready. United links 80 cities coast to coast, offers schedules around the clock and fares that include economical half-fare family plan. For information and reservations, call United or an authorized travel agent.

FLY UNITED

from San Francisco and enjoy a custom-planned post-convention tour to Hawaii. Wide variety of exotic tours in full range of prices. Just mail the coupon below for complete details.



POST-CONVENTION TOURS

Att. M. M. Mathews
UNITED AIR LINES
36 S. Wabash, Chicago 3, Ill.

Please send me complete Hawaiian tour information.

Name _____

Address _____

City _____ Zone _____ State _____

BPOE-SFO



Bruno Shaw with Senator Knowland in his Senate office during interview.

SOVIET AGGRESSION—

How the United Nations Could Curb It

BY SENATOR WILLIAM F. KNOWLAND
as told to Bruno Shaw

IF ANY MEMBER OF THE UNITED NATIONS wants to withdraw from membership in it, would you say it has the right to do so?"

The question was asked of me by Senator William F. Knowland of California during an interview I had with him last month to ascertain for *The Elks Magazine* whether, in his opinion, something might be done to bring to an end the Soviet Union's long record of violations of the United Nations Charter. The California Senator had been appointed by President Eisenhower to membership on the United States delegation to the U.N. just a few weeks previously. He had good reason, as we shall see, for pausing to interrogate me for a moment before making his direct reply to my opening inquiry of him.

Senator Knowland is a quiet-voiced, friendly, and usually quite reasonable man. But he is a tough man to try to hornswoggle where principle is at stake, and he becomes wholly unreasonable in the eyes of our national and international adversaries and their spokesmen and camp followers when, in dealing with Communist aggression, expediency is offered in exchange for a sacrifice of principle as something "just as good," and perhaps less costly.

The California Senator regards Communists, wherever they may be, as political cannibals. And it is his belief that the Soviet Union, the evil genius of the breed, could be restrained from aggression without resort to war, and that it could be compelled to cease its open disregard and flagrant violation of the U.N. Charter whenever it suits Communist purposes. All that is needed to achieve these twin goals, he says, is a little more dependence on principle, and less on expediency, by nations civilized enough to be able to distinguish between the two. There are enough of them, he believes, to be able to do so.

Getting back to Senator Knowland's question and the reason he asked it of me, I knew that he had advocated for a long

time the suspension of the Soviet from the United Nations unless the Kremlin agreed to abide by U.N. rules. I wanted to know from him how he proposed this might be done in the face of the prevailing notion that the Soviet veto power in the Security Council makes it impossible to punish or even to restrain Communist aggression.

Is that prevailing notion correct, I asked him, and are we really in the kind of fix where nothing can be done about it? That was when the Senator asked me the question you read at the opening of this article. My answer was, of course, that whether the United Nations Charter provided for it or not, it seemed to me that a sovereign nation either has the right to resign from an organization, in the same way that it has the right to decide for itself whether it wants to join it, or else it has lost its sovereignty.

That, said Senator Knowland, is precisely the point. Therefore, he declared, if we ever lose the right to withdraw from a group of nations with whom we do not want to remain associated, then we will have lost the right to determine our own destiny and we will have become a satellite of the group, or of the dominant nation in that group.

EVERY member of the United Nations has that same right, says Senator Knowland. And by the same token, he believes, nations with presumably kindred purpose—that of establishing and maintaining world peace and security—must have the right to expel from their midst any nation or nations which, in the opinion of the group, have demonstrated unfitness to be members of it. Otherwise, by being compelled to continue in abortive association with a wilful transgressor, the nations, as a group, will have lost their individual sovereign right to determine with whom they will or will not be associated. And when a group of nations gives up that right, declares Senator Knowland, they are no longer sovereign nations.

It is Senator Knowland's belief, however, that there is no basis for the prevailing notion that the United Nations Charter lacks provision for punishing

transgressors, or for expelling or suspending an aggressor. There is plenty of provision in the Charter, he says, for both. What has been lacking up until now, in his opinion, is just plain courage on the part of the civilized member nations to enforce the rights they have under the Charter. There has been too much wishful thinking that the Soviet Union's "new look" might mean a less murderous policy by the Kremlin, and that Red China's failure to do any armed invading of her neighbors in recent months might mean that the Red regime in Peiping has succumbed to civilized persuasions and that we ought to welcome it into the United Nations with open arms.

The sadistic crimes committed by the Soviets in Hungary with the enthusiastic approval of the Chinese Reds, says Senator Knowland, should dispel this nonsense once and for all. It is high time, he says, that the civilized members of the United Nations take a good look at the Charter and act in their own defense in the manner it provides they may do.

How can they protect themselves within the framework of the U.N. and its Charter? Here, says Senator Knowland, are some of the means that are ready and waiting to be used:

First, I should like to see us get the idea out of our heads that it is disgraceful for us to use the veto power in the Security Council. We must rid ourselves of the notion that if we use it freely in our own interest we will only be emulating tactics we have criticized in the Soviet.

For the past eleven years the Soviet Union has automatically employed a rubber stamp veto to reject any action by the United Nations that might conflict with Soviet interests or interfere with Soviet aggression. By doing this the U.S.S.R. has completely destroyed the usefulness of the Security Council for the purpose for which it was created—that of providing machinery to enforce world peace and security.

In the eleven years since the United Nations was established, we have seen the Security Council take action many times against non-Communist states, and secure voluntary compliance by those states. The latest example was British and French

withdrawal from the Suez Canal area.

No deterrent action, however, has ever succeeded against a Communist state, with one exception. The exception was Korea in 1950, when the Soviet delegate walked out on the Security Council, thus enabling the Council to vote to strike swiftly with joint military forces. The Reds will never dare to repeat that performance. They have been very careful, ever since Korea, to be on hand to exercise their veto in the Security Council whenever they or their satellites committed aggression. As witness their alertness to defeat any attempt by the United Nations to come to the aid of Hungary.

As a member of the United States delegation to the United Nations I can assure you that we do not want to emulate the Soviet Union. We do not want to match their indecencies and murders and aggressions with any of our own. Nor do we wish, because the Communists have tried their hardest to do so, to make the United Nations Charter a mere scrap of paper. But we would be fools indeed if we were to continue to allow the Soviets to use every chapter and article of the Charter to further their plot for world domination, and refuse to avail ourselves of the means we have to defend our freedoms, our lives, and our national sovereignty.

For example, our veto in the Security Council, without apology, whenever our own national interests would be in jeopardy by our failure to use it, is a means of self-defense. We should not deny ourselves the use of it. The veto is something more than the negative instrument the Kremlin has made of it. Failure by us to

(Continued on page 35)

United Press photo



Symbolic Chair—the empty chair of the Soviet Ambassador after he walked from a meeting of the United Nations Security Council.



Photo by George Abbate

WARRIOR'S RE



BY WILLIAM FAY

TURN

As an established business man, Slattery—wisely—had decided not to get involved in the free-lance affairs of his old companions.

ILLUSTRATED BY C. E. MONROE, JR.



GEORGE F. SLATTERY, the suburban manufacturer who created "Steve Sturdy, Space Sentinel," the all-aluminum doll, as well as "Manuel Mambo," the dancing doll, was a man equipped to appreciate a well-made article, or even to marry one, if things continued on their currently pleasant course. Her name was Thelma Travers and she had dropped into his place of business on a purely social errand. Thelma was twenty-six years old, tall in an interestingly proportioned way, hazel-eyed, of excellent family, and addicted to the arts in a manner which Slattery found uplifting and unsettling. He hadn't expected to be adopted this soon by the very best people in town.

"How in all this precious world did you manage to get them, George?" Thelma asked.

"The tickets?" Slattery smiled. "Tickets are tickets, aren't they? I just called a friend in New York and said, 'Three up front.' That's all there was to it."

"Daddy was amazed when I told him," Thelma said. "He tried twice through the bank but he couldn't budge the box-office people. And he loves *Otello* so. Don't you?"

"Love what?"

"*Otello*," she repeated. "The opera we're going to see. You know it, don't you?"

"Well, sure," he said, uncertainly. He had meant to say he knew they were going to the opera, not to a movie or a show, but it was plain to see she had interpreted his reply to mean he was acquainted with this particular opera. He felt the quick qualms of an honest man on the brink of a first deceit.

"I shouldn't have disturbed you when you were busy."

"It's nothing," he said. "There's someone waiting in my office, but let him wait." To himself, he thought: *I hope the bum doesn't walk out here.*

"Another thing, George," said Thelma. Her hair was chestnut-toned, abundant, lovely. The cool morning light of mid-November flooded the glass-walled premises of SLATTERY PRODUCTIONS, at Hasty Oak, N. J. It filtered through the reception foyer like the muffin-warmth of June. Soft chimes announced a coffee-break at exactly 10:45. "Daddy thinks you should expand the plant," Thelma said. "He feels you've done magnificently and the bank would be more than willing to—well, never mind—we'll save that for tonight."

"For tonight," said Slattery, "of course."

"Goodbye, dear," Thelma said.

Slattery returned to his office just a bit apprehensively. His visitor was a small man known as Willy "The Blood Bank" Shapiro, who was wearing a marcelled nose, a rose-tinged topcoat, a bright green shirt and a melt-

ing look of old comradeship. He was called "The Blood Bank" not in derision but in tribute to a talent for mending the split flesh of fighters in the one-minute rest between rounds. He worked for a fight manager named Ambrose "The Honest Doctor" Brady, who was, in all fairness, passably honest, but certainly no doctor.

"It's like old times," Willy said. "It's like when you were Doc's prize boy. Before you quit to become a genius, I mean. We're stayin' at the Hotel Paradise, on East Forty-Eighth. Me, Doc, an' our new heavyweight, 'The Viking.' We only got to town the other day."

"I saw it in the papers, Willy. I wanted to call you." Slattery chose not to say that as an established business man he had wisely decided not to get involved in the quaint, free-lance affairs of his old companions. Not that his affection for Doc had ever lessened, but because of a realization that they lived in different worlds. He felt a little mean about it, but what was a man to do? "I certainly would have called you if I hadn't been tied up in business," he said. "How is Doc?"

"Doc's in trouble," Willy said, without any cushioning preliminaries. "He needs you real bad, Slats. And right now. Today."

"Please," said Slattery, with a sinking, not unexpected sensation. "I can tell you right now that it's impossible."

"He's in trouble with Arthur Krugman," Willy said, and because, as Slattery knew, there was only one Arthur Krugman at large in all the wide, tormented world, Willy waited for the impact. His shrewd eyes remained on Slattery. "That's different, huh?"

"Are you sure this isn't one of Doc's smart gags?"

"A gag? It's a gag they clobbered the hell out of Doc an' robbed him of ten thousand, two hundred and fifty four dollars?"

"But why, Willy—why? You fellows just got to town. How could it happen so soon?"

"Don't ask me, Slats. You're the only guy that Doc'll tell. It means pick up your hat an' coat, pal. This won't wait."

"But, Willy, I can't! I've got a business to take care of. I have an important date for tonight. We're sane people out here."

"That's how much you care?" Scornfully, Willy set aside a free cigar he had taken from Slattery's humidor. "That's how you feel when I tell you your best friend in the world—the guy that could have made you a champion—has seven stitches in his head?"

Slattery sighed, then reached slowly for his phone.

"Let me have an outside line, please." He dialed thoughtfully. "Back already, Thelma? . . . No, this won't (*Continued on page 47*)

"This thing I got stuck in your back is not one of them space pistols", Henny said. "Walk over there".

"TO OUR ABSENT



A view of the principals in the moving Sunday afternoon Service conducted by the 3,283 Elks of Phoenix, Ariz., in the colorful outdoor setting of the lodge's beautiful park. In the background can be seen the floral decorated altar before which the ceremony took place.

ELKDOM'S traditional tribute to its "Absent Brothers" was offered once again on the first Sunday in December, 1956. On that day, every lodge in the Order conducted its annual Service honoring those members whose names have been added to the Tablets of Love and Memory.

Again, all lodges were invited to submit reports on their programs to the Grand Lodge Committee on Lodge Activities to be judged as to their preparation, presentation, attendance, appearance and altar display. Joseph F. Bader, the Committeeman in charge of this selection, reports that his decisions were difficult to make and that "a fine job was performed by all lodges participating".

This year, the lodges were classified in two groups—Group I for those of more than 750 members; Group II for those of less than 750, with three lodges in each group rewarded with a special plaque, to be presented at the Grand Lodge Convention in San Francisco. The programs conducted by these six lodges are described briefly here, leading off with those in Group I.

Outdoor Ceremony Wins Plaudits

The truly outstanding Service conducted by Phoenix, Ariz., Lodge was awarded top honors for lodges of more than 750 members. Held in the afternoon in the beautiful Elks Park, the ceremonies honored the memory of the 32 Elks who had passed away during the year, with Secy. Leo C. Gavagan reading the roll call. A moving memorial address was delivered before a large crowd by Rev. Father Barnabas Hughes, O.F.M., instructor at St. Mary's Boys High School, and several fine choral selections were presented by the Phoenix Orpheus Club of 75 voices. E.R. W. M. McMillon presided during an impressive altar service which highlighted the program planned by a Committee which had Hervey Mastin as Chairman.

Special publicity releases for the use of newspapers and local radio and television facilities, as well as individual letters of invitation for the families of deceased members, were responsible for the large attendance at the inspiring and beautiful program presented by Las Vegas, Nev., Elkdom. This ceremony, which won second place for lodges in Group I, was held on the tastefully decorated stage of the Las Vegas High School Auditorium. The Service, opened by the officers of the lodge, featured an excellent musical program highlighted by a solo by singer Connie Moore, well-known stage and motion-picture star, excerpts from "The Messiah" by the Rancho High School A Cappella Choir, and selections by the Kiwanis Quartette and the Sextette of the Latter Day Saints Church. The Elks' ladies performed the



The ladies of Las Vegas, Nev., Lodge were photographed as they made their way to the stage of the High School Auditorium, carrying lighted tapers for the impressive candle-lighting ceremony.



As the name of each Absent Brother of Savannah, Ga., Lodge was called, acolytes set a lighted candle in place before the altar on which these names were imprinted.

BROTHERS"

moving candle-lighting ceremony and P.E.R. Harley E. Harman delivered the eulogy. Secy. Austin H. Bowler was again Chairman of his lodge's Memorial Sunday Committee.

The Departed Brothers of Savannah, Ga., Lodge were eulogized by P.D.D. Henry M. Rosenthal, Chairman of the "Aidmore" Trust Fund Committee of the Georgia Elks Assn., at the third-prize-winning event in this category. Not only were these fine Services given wide advance publicity, insuring the public's awareness of the program, and the families of deceased members invited to attend, but Chairman E. M. Patterson, Est. Lead. Knight of the lodge, sent a special letter to all members who had been initiated since the 1955 Services had taken place, urging them to attend the 1956 event.

A Reception Committee greeted the guests as they arrived for the ceremony which was highlighted by a lovely musical program presented by the young ladies of the St. Vincent's Glee Club Choir. This Service, at which E.R. Walter Kiley presided, had excellent news coverage, and was televised by WSAV-TV.

Father Connelly Speaks

Leading the lodges of less than 750 members in this effort was Zanesville, Ohio, Lodge whose ceremony was planned by a competent committee headed by P.E.R. James Plummer, Secretary to Grand Exalted Ruler Fred L. Bohn, another P.E.R. of this lodge who was on hand for the program. Former Grand Chaplain Rev. Fr. Richard J. Connelly, Chaplain of the Ohio Elks Assn. and a member of Lancaster Lodge, was the inspired speaker at the exercises set before the appropriately decorated altar in the lodge home. The Services were opened by E.R. Avery D. Carpenter, and the Rev. G. S. MacCallum, Rector of St. James Episcopal Church, gave the invocation, with fitting vocal selections rendered by Wayne Fawcett and the eulogy delivered by Harold Gottlieb.

Not only did the printed program for this Service list the names of the ten Zanesville Elks who had passed away during the year, it also included the name of every deceased member since the lodge's institution in 1889. Both the Zanesville *Times Signal* and *Times Recorder* carried several advance announcements of this ceremony, as well as covering reports on the Services. In addition, the Sunday *Times Signal* devoted a full page to the Elks, carrying not only the Services report, but a reproduction of the excellent story which had been published on the Order's activities by the *Christian Science Monitor*.

James E. Lanigan, President of the Fulton Board of Education and head of the

(Continued on page 46)



Zanesville, Ohio, Lodge officers and participants in its outstanding Memorial Services are pictured before the altar. Left to right foreground are Wayne Fawcett, soloist; former Grand Chaplain Rev. Richard B. Connelly, speaker; Harold Gottlieb, eulogist, and Rev. G. S. MacCallum.



The officers of Fulton, N. Y., Lodge were photographed during their prize-winning Memorial Sunday program.



This was the scene as Rocky Mount, N. C., Elks paid tribute to its Departed Members. Left to right: Esq. W. R. McAuley, E.R. Henry B. Johnson and Secy. Norman Y. Chambliss, Sr., P.E.R. of the lodge.

Good Pitchers Take Charge

A consistently winning pitcher has to be a good psychologist and half bulldog. If he can't out-think a .300 hitter he's in trouble.

BY FRANK C. TRUE

**ILLUSTRATED BY
WILLARD MULLIN**



WHEN spring training season in baseball rolls around each year, the same question inevitably is asked by thousands of Americans who enviously study training camp pictures bathed in semi-tropical sunshine. What does a major league manager have that justifies such a large salary? It's a loaded question.

Most business executives, once a problem of a specific type has been solved, know how to proceed if it recurs. In big league baseball, however, the situation is upside-down. No manager ever knows what to expect of a rookie pitcher, regardless of minor league records, until all the results are in—and even then he isn't too sure.

At the moment in St. Petersburg, Fla., some enterprising baseball writer, impressed by the performance of a rookie pitcher, might well be asking that sage among managers, Casey Stengel:

"How does he look to you, Casey?"

And the non-committal answer, as always in the past, will be: "Well, he's a likely lookin' feller. Throws hard; got good curves, but I ain't sayin' more'n that right now."

The same answer, with a slight variation in words, could be expected from any manager in the majors. In short, the judging of rookie pitchers belongs in the "unclassified" drawer. There never has been, and probably never will be, a set formula.

Suppose, for example, you'd just inherited a major league club, had extensive financial resources and were in desperate need of a starting pitcher—a real stopper who might be a potential 20-game winner.

Your scouts, let's say, inform you the woods are bare. No rival club, naturally, can be induced to give up a top-flight pitcher in a deal involving money only, so you decide to conduct a search on your own.

Just what qualities will you look for? If a likely prospect can throw hard, has a sharp curve and reasonably good control, have you found your man? The odds are something like 20 to 1 you've merely dug up another pitcher whose assets can be matched by countless headstones in baseball's graveyard—the minors.

If you were only looking for an infielder, outfielder or catcher, yes, you could read a young player's typewritten record and almost make up your mind. But you need a pitcher.

Well, you may ask at this juncture, if there's no answer, why belabor the question? Why not just admit it's like selling fish out of a barrel and let it go at that? But maybe—just maybe—if we wander far enough through the top echelon of baseball, gathering opinions from the great and near-great who have pondered the question down through the years, we might put together pieces of a jig-saw puzzle and come close to a solution. Anyway, it's worth trying.

THE late John McGraw reached an ironical conclusion near the end of his career. He opined that a man reached the pinnacle of wisdom about pitchers when he became smart enough to realize he knew nothing "for certain" about any of them. And don't forget, McGraw looked at some pretty fair pitchers in his day, including Christy Mathewson, Rube Marquard and too many others to mention.

Since McGraw's day theories have multiplied, but, instead of clearing the atmosphere, the problem has only become more entangled. It all seems so simple. Ask any fan—that bellicose, self-sufficient type of individual who always knows more about pitchers than any manager who ever lived—and he'll give you a ready answer. But if you should go into a big league press box and put the question to baseball writers who have been looking down upon the scene for decades you'd find unanimity on one point only; namely, that it takes a lot more than good curves, speed and control if a rookie is to wear a major league uniform very long.

Suppose we embark by talking to Carl Hubbell, one of the greatest pitchers the game has ever known. Carl is now manager of the New York Giants' farm system, where young players are developed.

"I don't believe there ever has been or ever will be a pitcher who can tell in advance of warming up for a game whether

his 'stuff' will be breaking right or wrong that day," said Carl. "A good night's sleep and all that sort of thing has nothing to do with it. On days I've felt best, I've been at my worst. Don't ask me why. I don't know.

"There is one thing, though, which can be used as a yardstick in judging pitchers. If a man habitually gets 'butterflies in his stomach' on a showdown pitch, he isn't long for the big time. How many times have you seen a pitcher have batters at his mercy for eight innings, then, with the bases full in the ninth, two out and the balls-and-strikes count on the batter 3 and 2—boom!

"It may sound funny, but a winning pitcher also has to be a good psychologist and half bulldog. If he can't out-think a .300 hitter, he's in trouble. If he displays anxiety, he's a gonner. He must be able to keep a batter constantly off-balance mentally, never giving him what he expects. He needs the courage of a poker player who bets everything on one hand."

All of which explains why most experts agree that winning a ball game is 60 per cent dependent upon pitching.

For a batter's viewpoint, let's go to one of the greatest of all time, Mel Ott, whose lifetime record of 511 home runs is surpassed only by Babe Ruth and Jimmy Foxx.

"A batter usually can tell when a pitcher fears him," grinned Ott, who's now a radio broadcaster in Detroit. "The pattern seldom changes. The pitcher works the balls-and-strikes count up to 2-2, let's say. On the next pitch, if he's faint-hearted, he'll probably try a curve that breaks on the outside of the plate, realizing he can waste that ball, and hope the batter will be dumb enough to go for it.

"It's in a situation like this that a smart pitcher who's long on courage will try to out-think the batter. He knows the man at the plate will be expecting a wasted pitch. He'll also realize that if the balls-and-strikes count is allowed to go to 3 and 2 the batter will be dug in and ready to tee off on a subsequent fast ball 'aimed' at the plate.

"So what happens on a 2-2 count with a pitcher who has nerve? He shakes his head at the catcher a couple of times, just to make it appear a curve is coming up, then splits the plate with a fast ball. Under such circumstances, there's a good chance the batter, looking for a wasted outside curve, will be left standing with his mouth open. It doesn't always work out that way, of course, but the stupidest thing a pitcher can do is to expect a seasoned batter, with the chips down on a 3-2 pitch, to go for an outside ball in

(Continued on page 43)



As one trainer who has seen a parade of good and poor pitchers pass by says, "The qualities most needed are brains, nerve, speed, control—and a good shortstop."

Across the Country with Your Service Commission

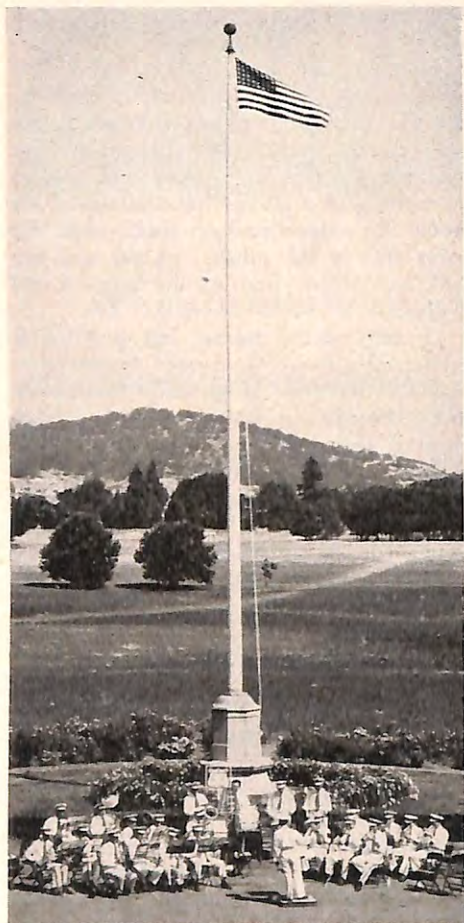

Above: Photographed on the grounds of the Veterans Hospital at Roseburg, Ore., is the Lebanon Elks Band which entertained during a veterans picnic there sponsored by the Elks of Roseburg several months ago.



Left: The South Carolina Elks Assn. presented a portable TV set to the Veterans Hospital in Columbia recently. Participating in the presentation are, left to right, Asst. Chairman Fred Roukus and Chairman Augustus Fitch, Jr., of the Elks' Hospital Committee, Asst. Mgr. H. S. Kennerly of the Hospital, Chief of Special Services W. E. Czarnitzki, Asst. Special Services Officer Buck Smith, D.D. C. E. Barfield and Dr. R. W. Houseal, Chief of Surgery at the Hospital.



Right: D.D. J. T. Lester, right, and E.R. John B. Moon of Columbus, Ga., Lodge pictured with Pfc. Vincent Nunziato of New Hyde Park, N. Y., a patient at Fort Benning's U. S. Army Hospital, during the Elks' visit when they distributed ice cream and cigarettes to the servicemen there.



Above: On Hospital Day at Newton D. Baker VA Center, when volunteer workers at the Center were honored, Asst. Mgr. J. E. Darby, right, presented a certificate for 500 hours of service to Garnett W. Shipley, Chairman of the Martinsburg, W. Va., Elks Veterans Service Committee, center, and a certificate for 100 hours of service to Co-Chairman Thomas Waters, left. Mr. Shipley, who is also the State Elks Committee Chairman, received an additional certificate for attendance at the monthly VAVS meetings.



Guests attending Veterans Night at Compton, Calif., Lodge included Exalted Rulers and Veterans Committee Chairmen of the South Central Dist. Coast Lodges. Principal speaker of the evening was State Chairman Robert N. Traver, fifth from left foreground, shown as he was welcomed by Dist. Chairman Dale C. Shellhaas, who handled the program, second from right, with host E.R. James E. Melvin, wearing his jewel of office, standing between them.

Lodge Visits of FRED L. BOHN



On November 15th, a delegation of New Jersey Elks escorted Grand Exalted Ruler Fred L. Bohn to the Passaic County Cerebral Palsy Center, and present were, front row from left: Past Exalted Rulers Leo Slater and Anthony Marino of Paterson Lodge; John Wegner, Past Exalted Ruler of Paterson Lodge and Chairman of the Board of Directors of the Clinic, (Mr. Bohn), Past Grand Exalted Ruler William Jernick; Dr. Joseph Derose, Physician in charge of the Clinic; Marvin B. Martinique, Exalted Ruler of Passaic Lodge and Albert Levedusky, Past Exalted Ruler of Passaic. Rear row: Past Exalted Ruler John Skelly, Clifton Lodge; State Vice President D. V. Crosta; State President Dr. Louis Hubner; Past Exalted Ruler Clifton Lodge, Kenneth Force; District Deputy Richard J. Tobin; Past Exalted Ruler Leo W. Eirich and Exalted Ruler W. Valentien, of Pompton Lakes Lodge.



When Grand Exalted Ruler Fred L. Bohn was at Findlay, Ohio, Lodge on January 12th, he presented Brother Del D. Drake, Sr. with an honorary life membership. Brother Drake has been a member for fifty years and has been directly responsible for the affiliation in the Order of over 400 members.



Present at the banquet held at Littleton, N. H., Lodge, which was given in honor of the Grand Exalted Ruler by that lodge, and also Berlin Lodge, were, from left: Exalted Ruler Richard Poirier, Berlin; District Deputy Henry Salvail; (Grand Exalted Ruler Fred L. Bohn); Past District Deputy Patrick Hinchey; Past Grand Exalted Ruler John F. Malley and Exalted Ruler Richard P. Whiting of Littleton Lodge.



Dickinson, N. D., Lodge held a banquet, honoring the Grand Exalted Ruler on the occasion of his visit, and among those present were, from left: Exalted Ruler Clint Weber, District Deputy A. T. Livdahl, (Mr. Bohn), Grand Lodge State Association Committeeman Ray Dobson, Past Grand Exalted Ruler Sam Stern, Past District Deputy Ed Tobin, State President Wallace D. McKenzie and Father Felix Andrews, State Chaplain.

Ohio Elks Entertain Grand Exalted Ruler at Findlay

On January 12th more than 600 Elks and their wives welcomed Grand Exalted Ruler Fred L. Bohn to Findlay, Ohio, for the two-day meeting of the Northwest District of Ohio. Mr. Bohn arrived that afternoon from Upper Sandusky by motorcade escort in accompaniment by State President Herschel Deal and other Grand Lodge and State Officers. Present to greet the Grand Exalted Ruler were Exalted Ruler Robert E. Jones and District Deputy Elmo Richards. A banquet was held that evening, at which Brother Jones presided. At the banquet a gift in appreciation of his untiring efforts in the cause of Elksdom was given by the Northwest District to Mr. Bohn, the presentation being made by Past State President Lou Kuenzli. Other Ohio State Association officers present were Past Presidents Walter Bier, Joe E. Hurst, E. Gene Fournace, John Neate and William J. Schwartz, as well as Vice-President James Plummer, Secretary to the Grand Exalted Ruler, and Martin Fiegert.

Grand Exalted Ruler's Itinerary*

- Feb. 23 Anniversary banquet of New York Lodge No. 1
- 24 Rhode Island Elks Assoc. Dinner at Providence
- 25 Massachusetts Elks Assoc. banquet at Boston
- 28 Zanesville, Ohio
- March 2 Elks National Bowling Tournament, Columbus, Ohio
- 9 Joplin, Mo.
- 18 Huntsville, Ala.
- 19 Birmingham, Ala.
- 20 Luncheon at Buckhead (Atlanta); night meeting at Rome, Ga.
- 21 Atlanta—night meeting
- 22 Anderson, S.C.
- 23 Brunswick, Ga.
- 24 Afternoon reception at Jacksonville, Fla.
- 25 Luncheon at Harry-Anna Hospital; night meeting Eustis, Fla.
- 26 Luncheon West Palm Beach; night meeting and dedication of new home at Lake Worth.

*Itinerary subject to change.

News of the Lodges

Alaska Elks Welcomed to Juneau Meeting

The Elks of Juneau Lodge No. 420 were hospitable hosts to 600 Elks and their ladies who met there for the 9th Annual Alaska Territorial Elks Convention Nov. 15th, 16th and 17th. Former Grand Tiler M. E. Monagle, President of the group, opened the session, with Rev. Robert J. Whalen, S. J., giving the invocation. E.R. G. H. Gissberg introduced the Exalted Rulers of the other 11 member lodges who were present, after extending an official welcome, along with Mayor M. L. MacSpadden, and W. E. Hendrickson, Secretary of Alaska, both members of the Order.

The Convention was honored by the presence of four Elk dignitaries from the State of Washington—Past Grand Exalted Ruler Emmett T. Anderson and his son, P.E.R. Burrirt B. Anderson of Tacoma Lodge, Pres. William C. King of the Washington State Elks Assn., and Special Deputy Edwin J. Alexander of Olympia. All of these visitors addressed the delegates, giving counsel and encouragement on their cerebral palsy work, the effort they've adopted as their Major Project, emulating the Washington Association which has made great progress in that field.

This project, which is in its first operational year in Alaska, has advanced more rapidly than anticipated, as the result of the efforts of the Cerebral Palsy Commission headed by E.R. Robert D. Lewis of Anchorage Lodge. During the report of this Commission, the delegates had the opportunity to witness actual

demonstration of the type of treatment given these handicapped youngsters. Their two physical therapists, Elk Dave Morris and Miss Mabel Nihoul, were on hand, with one of the children who have shown remarkable improvement as a result of the assistance afforded them by the Alaska Elks Association.

It was decided that the 1957 Convention would be held at Anchorage, and the following officers were elected to head the organization until that time: Pres., John Gibbons, Kodiak; Vice-Pres., West, Hal Gilfilen, Seward; Vice-Pres., East, William Stump, Ketchikan; Secy.-Treas., Richard W. Smith, Anchorage, and Trustee, E. Robert Haag, Juneau.

Muskegon, Mich., Elks' Hold Football Dinner

Before the largest crowd of guests ever to assemble at a football banquet, the entire history of the gridiron in Greater Muskegon was unfolded as the highlight of the 1956 edition of the annual event held by Muskegon Lodge No. 274.

Sports Editor James F. Henderson narrated the part played by local athletes in this great sport in the presence of coaches and All-State players and the mighty Bennie Oosterbaan, fabulous head coach for the University of Michigan whose exploits both as coach and three-time All-American and Hall-of-Famer furnished the meat of the Sports Editor's review.

E.R. John B. Olsen extended his lodge's welcome to the gridiron stars who were the guests of honor, and Thomas Fallon was a capable Master of Ceremonies for the banquet program directed by Trustees



On Old Timers Night at Macomb, Ill., Lodge, when a class of 15 was initiated in honor of State Pres. George Thornton, E.R. Wendell S. Smith, right, was photographed as he presented a 50-year-membership pin to Charles Hanan, center, and a 25-year pin to Mr. Hanan's son, Edgar, who is pictured at the left.

James Pugh and Donald Werschem and their committee.

Elk Oscar Johnson, coach of the Muskegon Heights High School eleven, together with two of his players, received the coveted Oosterbaan Trophy, symbolic of the Southwest Michigan championship, from the hands of the great sports figure for whom it is named.

Fire Destroys New Home of Cambridge, Md., Lodge

Just last month you read in these pages of the dedication of the new home of Cambridge Lodge No. 1272, at which Past Grand Exalted Ruler Dr. Robert South Barrett officiated. On January 10th, just two months after this ceremony, the building was destroyed by fire.

The blaze, which was discovered in the basement near the newly converted furnace, was out of control almost immediately, fanned by a 40-mile-an-hour wind. Although four companies responded to the alarm, the building was leveled within half an hour. Officials estimate their loss at \$65,000; destroyed were many valuable antiques and all the lodge jewels, but the greatest loss was the original Charter



Photographed at the dedication of the new home of Toledo, Ore., Lodge, attended by 1,200 Elks from all over the State were, left to right, Chairman Frank Hise of the Grand Lodge State Assns. Committee, Special Deputy Clifton B. Mudd, Past Grand Exalted Ruler Frank J. Lonergan, host E.R. Carl T. Robertson and D.D. Fred Simpson.



Portland, Ore., Lodge's State Billiard Champions are pictured with the George Harris Trophy presented to them by Chairman Frank Hise of the Grand Lodge State Assns. Committee at a Corvallis Elk banquet. Left to right: Harry Adams, Capt. Bob Harris, Lee Leclair, Ernest Norgarden, Albert Weller. Sixth member Phil Johnson was not present.

of the 45-year-old lodge, which included the names of three of Maryland's Governors, and 41 years of lodge records.

Fortunately, the building was covered by insurance, and E.R. L. D. T. Quinby and his 430 Brother Elks are planning even now to rebuild. A ball had been scheduled for January 12th, and in spite of the tragedy, it went off as planned—in the lodge's old home, vacated in October, with about 150 guests on hand.

Berkeley, Calif., Elks Fête Football Lovelies

In line with the Elk policy of participation in community affairs, Berkeley Lodge No. 1002 has for many years taken an active part in the Annual Football Festival in cooperation with the Junior Chamber of Commerce.

This year a civic luncheon was held at the lodge home for 300 community leaders and city officials, with the guests of honor the coaching staff of the University of California and 15 lovely football queens from leading universities of the country. The Festival Queen elected for 1956 was Miss Donna Cason, a beautiful University of Oklahoma student, and she and her court were again guests of the Elks at a dinner on the evening of the colorful Parade of Lights, which is one of the many spectacular events of this week-long celebration. At this time, Miss Cason and her attendants were welcomed by E.R. and Mrs. Paul S. Moffatt, and a large number of other Berkeley Elks and their wives.

Louisiana Elks Meet at Natchitoches

The members of Natchitoches No. 1363 acted as hosts to a well-attended Mid-Season Conference of the Louisiana State Elks' Assn. The meeting was called to order by Pres. Clarence LaCroix, and a warm welcome was extended by Mayor Frank Kees, a member of the lodge.

Nearly all lodges of the State were represented at this session which was attended by the Association officers and during which the various committees for the current year were appointed.

Treas. A. B. Culliton, District Deputy for Northern Louisiana, presented a financial report for the organization, and a fine progress report on its Major Project, the Southern Eye Bank, was read for Willis C. McDonald, the Chairman in charge of this program who was unable to be present.

Highlighting the social aspect of the gathering were a buffet luncheon and dance at the home of the host lodge. Shreveport will be the site of the 1957 Convention of this Association on May 24th, 25th and 26th.

At this Mid-Season Meeting a resolution was adopted protesting the action to amend various Federal laws relating to the taxing of fraternal organizations, particularly in connection with the club and guest facilities of lodge homes.



Presenting checks totaling \$5,000, the Connecticut State Elks Assn. completed payment on the construction of a pavilion and enclosure for the Newington Home and Hospital for Crippled Children. In addition, the Assn. also gave a truck with hydraulic rear lift on which the children may be transported to play and picnic areas. With some of the youngsters are, left to right, foreground, Bridgeport E.R. E. F. Reagan, Hospital Trustee and Chairman of the Grand Lodge Committee on Lodge Activities Arthur J. Roy, State Assn. Secy. Thaddeus Pawlowski, State Pres. E. J. Maley and Chairman Ben Schlossbach of the Assn.'s Crippled Children's Committee. On the lift is George Sanford, the Hospital's Recreational Director, and in the center background are Assn. Trustees Chairman John J. Gillespie, left, and Hospital Director B. E. Foss.



E.R. and Mrs. Paul Moffatt welcome Miss Donna Cason, center, Football Festival Queen from the Univ. of Oklahoma and her court of queens from leading universities, to a dinner given by Berkeley, Calif., Lodge for the young ladies during Football Festival Week.



Long Beach, Calif., Lodge is proud of its "888 Rangers", a group of members famous for their community activities. A dozen were pictured here as they donated blood to the Red Cross recently.

ADDRESS OF GRAND EXALTED RULER FRED L. BOHN: Rooms 121-122, Zane Hotel, Zanesville, Ohio
ADDRESS OF GRAND SECRETARY LEE A. DONALDSON: Elks National Memorial Building, 2750 Lake View Ave., Chicago 14, Ill.

Elks Aid Hungarian Refugees

E.R. John Stuart-Menzies, left, purchases specially fitted skates for Hungarian refugee skating champion George Stern, center. Mr. Stuart-Menzies called the gift, which he made on behalf of Great Neck, N. Y., Lodge, a "symbol of America's desire to promote sports, sportsmanship and fair play throughout the world".



Another group of Elks to donate generously to Hungarian Relief is the membership of Charlotte, N. C., Lodge which presented a \$1,000 check from its Charity and Welfare Relief Fund to the local Red Cross for aid and assistance to Hungarian refugees. E.R. A. L. Ducker, right, handed the gift to Chairman C. C. Hope, Jr., of the Mecklenburg Chapter of the Red Cross who stated that the gift was the largest single donation which had been received during the Drive.

ONE of Hungary's most popular athletes, 19-year-old George Stern who holds two of his country's all-time speed-skating records, enjoyed a sample of the true spirit of Elkdom when he spent the 1956 Holiday Season as the guest of Great Neck, N. Y., Lodge, No. 1543.

The young man, a member of the Hungarian Olympics team, escaped from Hungary in November; while applying for immigration to the United States at the Salzburg office of United Hias Service, the American-supported migration agency, he was befriended by a Great Neck journalist, Martin A. Bursten, who was then gathering news material for American media.

When Stern indicated that he'd been told life in American communities was not at all as it was pictured by the Voice of America and Radio Free Europe, Mr. Bursten invited him to visit Great Neck on his arrival here. Shortly after he reached Camp Kilmer, the refugee visited the Bursten family where he was most helpful in identifying scenes of the October revolt in

Budapest which were part of a documentary movie being produced by Mr. Bursten for distribution by United Hias.

It was this film which was previewed at the home of Great Neck Lodge as part of its "Hungarian Relief Night" program Chairmanned by P.E.R. Franklin G. Edwards who heads its Activities Committee. The showing was the result of a promise given E.R. John Stuart-Menzies by the producer before his departure for Europe. Portions of the film have been used by all major TV networks and newsreel theaters.

During George Stern's visit to Great Neck, all his doubts as to the American Way of Life were dispelled by the kindness he received in his Elk-conducted tours of shopping centers, libraries, the Kings Point Merchant Marine Academy and his attendance at Temple Beth El services.

The son of a Budapest physician, George has been settled in Syracuse and hopes to complete his studies there so that he may follow in his father's footsteps.



Photographed at the Alaska Territorial Elks Association Convention in Juneau are Association officials and visiting dignitaries. Left to right, foreground, are Pres. William C. King of the Washington Elks Assn., P.E.R. Burritt B. Anderson of Tacoma, Wash., Lodge and his father, Past Grand Exalted Ruler Emmett T. Anderson, Alaska Assn. Pres. John Gibbons, former Grand Tiler and Alaska Past President M. E. Monagle and Special Deputy Edwin J. Alexander, former Chairman of the Grand Lodge Committee on Lodge Activities. In the second row are Alaska Assn. Trustees E. R. Haag and Hollis Henriks, Past Pres. E. G. Barber, Trustee Quintin DeBoer, Vice-Pres. Hal Gilfilen and Secy.-Treas. Richard W. Smith.

(Lodge News continued on page 25)

Report on RUSSIA

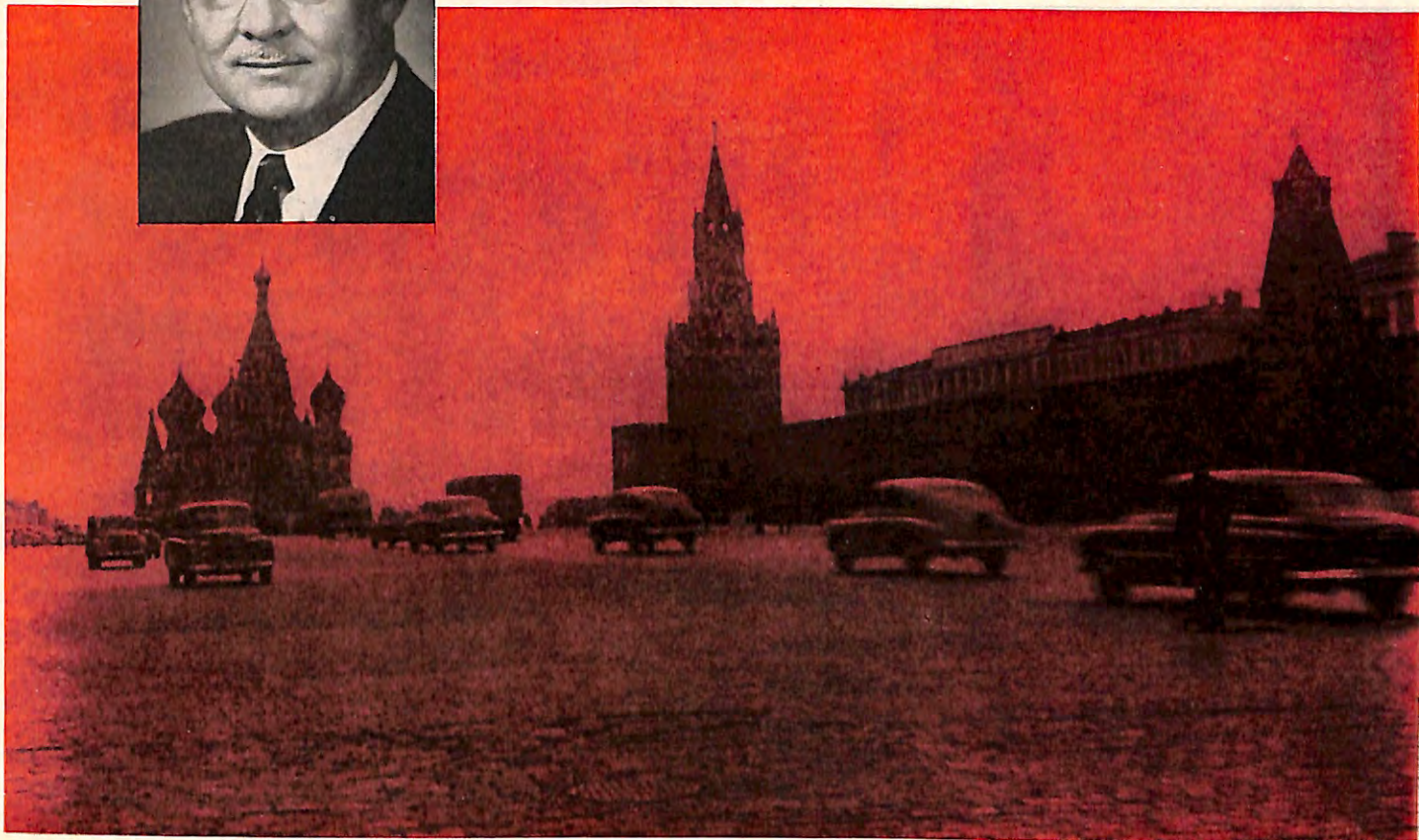

Mr. James took this snapshot of Red Square pointing up how few and dated are the cars.

Past Grand Exalted Ruler Earl E. James Gives an Account of His Trip Behind Iron Curtain.

PAST GRAND EXALTED RULER EARL E. JAMES is one of the few private U. S. citizens who have had the opportunity to get a first-hand look at life in the Soviet Union. With 28 other men, he recently made a six-weeks tour of Russia that covered a large section of the European portion of that country. Most of the group were Oklahoma ranchers and farmers, but it included, in addition to Brother James, another lawyer, a newspaperman, a television cameraman-reporter and a physician from Wichita, Kans. The tour was organized by an Oklahoma publishing firm, and was "in exchange" for the tour of our midwest region by a group of Russian "farmers", some of whom were said not to be farmers at all but Soviet officials.

Brother James took some 900 color photographs on his travels that included Leningrad, Moscow, Kiev, Kharkov, and Sochi and Sukhumi on the eastern shore of the Black Sea in Georgia, the late Stalin's home territory. En route, the party visited numerous collective farms and villages in the northern regions and in the Ukraine.

He has presented illustrated lectures on

his Russian visit to many groups throughout the country, giving them the benefit of his observations on life in the Soviet Union. Particularly strong was his impression of friendliness on the part of the common people with whom he came in contact. This friendliness toward Americans was especially evident, he noted, on those rare occasions when the official communist guides were not hovering at his elbow.

In striking contrast to living standards in this country were the primitive conditions generally found even in the large cities. Housing is very limited. In Moscow and other cities, entire families live in a single small room. Private kitchens and baths are extremely rare. Community kitchens and sanitary facilities are the rule in apartment houses. Electricity appeared to be in short supply, because it is shut off in hotels and residences during the daytime.

Brother James reports that the clothing worn by the "man on the street" was uniformly rough, poorly tailored. He noted the absence of color in clothing worn by both men and women. It was generally black or of other somber shades.

The touring Americans found that much of the war damage in the larger cities has yet to be repaired. Brother James noted that new construction progressed painfully slowly. He saw many buildings in Leningrad and Moscow that obviously had been under construction for years. Construction standards are low. He saw electric wiring being installed after construction had been completed. The wires were tacked to walls without regard to the safety requirements demanded in this country. In the same vein, plumbing fixtures being installed were old-fashioned types.

Remembering America's traffic-choked streets and highways, Brother James was struck by the small number of motor cars using the broad streets of the large cities. What few cars there were, for the most part belonged to the embassy staffs or to high communist party functionaries. Few ordinary citizens have the means to acquire an automobile, let alone maintain it.

A conspicuous characteristic of Russian life is the custom of using women for the heavy work. Moscow's women street cleaners are well-publicized, but he observed women elsewhere engaged in laborious work, while the men did the less taxing labor. It seems to be the rule.

Especially interesting were the collec-
(Continued on page 45)



**You're Invited
to join the Grand Exalted
Ruler's train to
CALIFORNIA**

Going to the Grand Lodge Meeting in San Francisco, July 14-18? Northern Pacific is honoring the Grand Exalted Ruler with a special train leaving Chicago, July 8th, circling the scenic Northwest via the Twin Cities, Seattle, Portland — to California.

As an Elk, you're cordially invited to join NP's convention party, headed by Fred L. Bohn of Zanesville, Ohio, and to enjoy the fellowship, sightseeing and fun on the way.

The Grand Exalted Ruler's Special will stop one day in Montana and one day in Washington state for planned entertainment. Arrival in San Francisco will be on the evening of July 13.

Individual Elks, their families and group delegations of all sizes are welcome on board the Grand Exalted Ruler's Special. Reduced family fares apply for the trip.

Why not combine a wonderful western vacation with attendance at the inspiring Grand Lodge sessions in July? Today, write for our *free* travel program folder, "Grand Exalted Ruler's Train." Even if you're not a delegate to Grand Lodge, you'll enjoy reading this fascinating brochure which includes attractive post-convention trips.

For your free Elk folder and travel information, address:

NORTHERN PACIFIC RAILWAY
73 E. Jackson Blvd., Chicago 4, Illinois

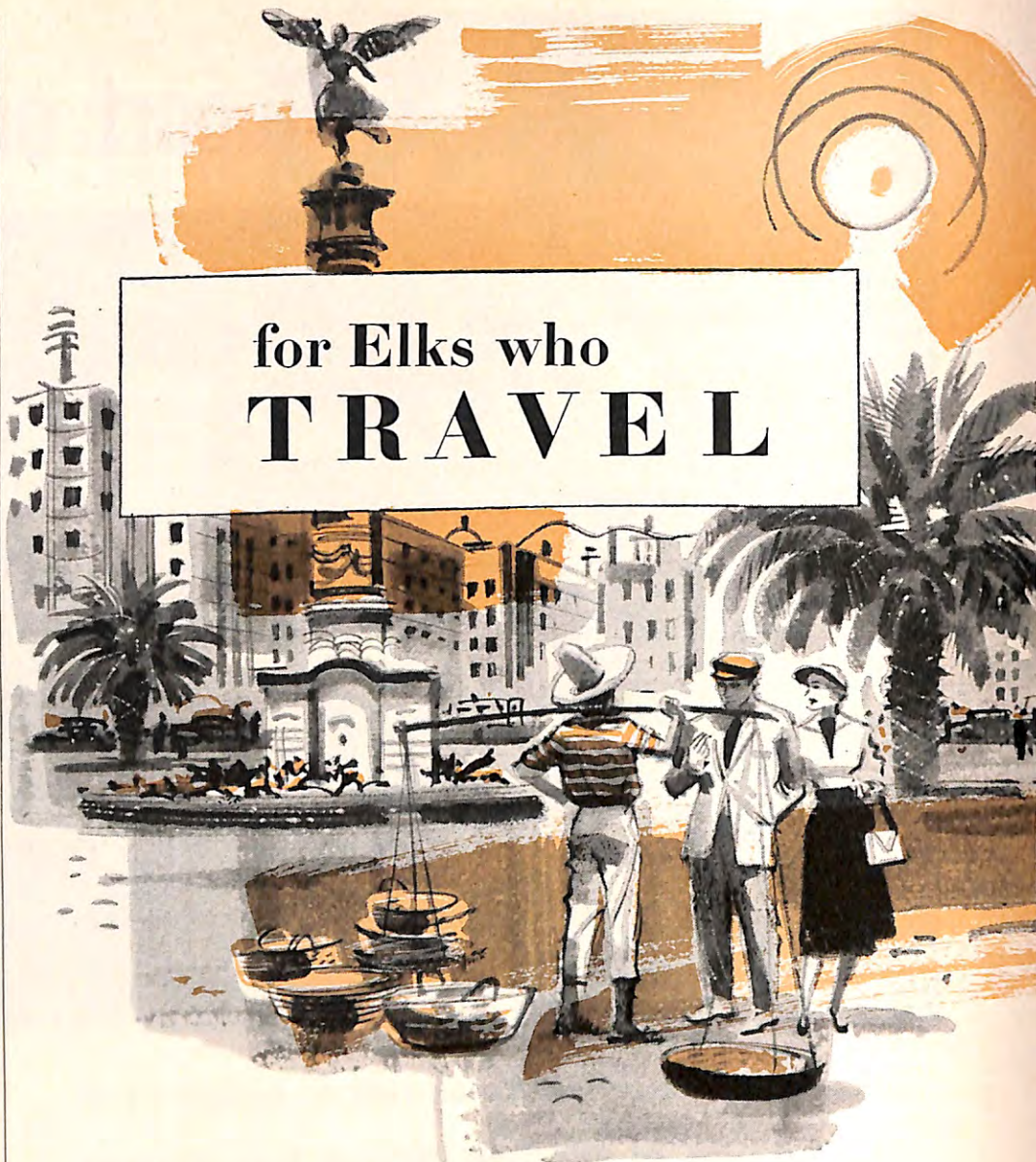

for Elks who
TRAVEL

**The latest in tourist accommodations are
rapidly taking over in old Mexico City.**

BY HORACE SUTTON

IF THIS KEEPS UP the most modern-looking city on the continent will probably be Mexico City, which is rapidly developing into a lofty plateau spired with monuments of smooth brick, chrome, and glass. Along the Paseo de la Reforma, a broad avenue of both gentility and history, there is the tower that houses our embassy, there is a modernistic bank, a new Woolworth's, a rakish department store and an assortment of shiny new hotels not the least of which is the Continental Hilton which opened to a fancy party of Hollywood and New York types just before Christmas. An air-conditioned 16-story V-shaped temple, the new Hilton extravaganza has 400 rooms, all with bath, radio and telephone and many with private terraces overlooking the *ciudad*. High on top is the Belvedere with its broad picture windows that look off over the heads of the

city to the snow-topped volcanoes of Popocatepetl and, you should pardon the expression, Ixtlaccihuatl.

I shudder to think of what the prices may be—for it wasn't finished when I was there—but the Hilton also houses a French restaurant of "extreme luxury and elegance" finished *à la* Louis XV, with silk damask walls, crystal chandeliers and glassware, and a bronze stove. It has a terrace for the balmy days of summer. Mexico City nights in winter can be chilly.

It is just a short walk down to the Reforma Hotel which, now in the hands of Intercontinental Hotels, has been completely refurbished. Among other innovations it sports a soda fountain bar and a dining room, both virtually in the lobby. Another of the new hotels in the Capital is the Alffer at Revillagigedo No. 18. It, too, makes ample use of its roof on which it sports a

ILLUSTRATED BY TOM HILL



for a trip you'll
always remember,
travel via Santa Fe
on your way to the

ELKS

National Convention
San Francisco
July 14-18, 1957



You can choose from five fine trains operating daily between Chicago and California. Also, swift, daily schedules between Texas and California.

On these trains you will find a complete choice of accommodations and service for individual and group travel.

For complete travel information see your nearest Santa Fe passenger representative.



R. T. Anderson, Gen'l Pass. Traffic Mgr.
Santa Fe System Lines, Chicago 4

few small golf holes, swimming pool and the night club known as the Rondinella where you can dine and dance with a view of the city twinkling outside. Not far away, a snug little nest of a hotel, called the Bamer, also has an eagle's nest with an outdoor terrace looking across to Alameda Park.

To match its growing list of modern hotels Mexico City has sprouted a number of new and handsome restaurants, which, added to the cadre of well-known places like the 1-2-3, and the Jena, give the traveler a varied assortment of plush places to go. The decor at the Focolare, the Quid, and the Parador, to mention only a handful, is full of rich leather, spacious surroundings, bird cages, waterfalls and who knows what all. The only trouble is that many of them, while serving Mexican food on demand, seem to specialize in that good but nondescript international kitchen. And in that department, Mexico will have difficulty keeping up with the best of New York, San Francisco, New Orleans and Paris.

As for the Mexican kitchen itself, for anybody with an asbestos stomach it is an exciting experience. Beginning with break-

fast when the Mexicans take their eggs doused in *salsa rancheros*, and running through the *frijoles*, which are mashed beans, the *guacamole*, the *tacos* and *tortillas*, the fare is not unlike a string of Chinese firecrackers exploding on the tongue. Much is made out of the lowly cactus. The maguey type yields *agua miel*, or honey water, which when fermented becomes *pulque* and eventually, tequila. Tequila is a colorless intoxicant which, if you follow the local custom, you drink after a succession of tastes of a lime and a lick of salt which should be held on the bridge of one's hand where thumb and forefinger join. Tequila is 100 proof, but whether drinking it or other hard liquor it might be noted beforehand that Mexico City is located at 7,400 feet and a drink at the Capital is worth three by the sea. As for the rest of the cactus, it also is home for a worm known as the *gusano de maguey* which finds a sanctuary in the cactus leaf at the beginning of the rainy season and is later extracted. Now the Mexicans don't consider this a blight. They broil the worms or sometimes fry them and then they spread them in a tortilla, which is a soft pancake,

(Continued on page 38)

with Ed Faust



In the Doghouse

This month Ed ends up by becoming technical.

THIS ARTICLE, of course, will be about dogs, but where it is going to end is, as I write, as much a mystery to me as it is to you. If you stay with me, or bear with me, you may find us wandering all around the world of dogs touching on matters that may seem unrelated but having one thing as a common denominator—dogs.

As you may suppose, this department of your Elks Magazine receives a number of letters from readers throughout the year asking questions about dogs and some who just write to tell something about dogs they own or have owned. All are welcomed and answered. Occasionally when writing these articles I may use a technical term which to some readers who are not experienced with dogs beyond keeping a house pet or two may find puzzling. Frankly, the writer who writes to a non-technical audience and employs the jargon of his trade is guilty of literary bad manners. It's so easy to assume that the reader knows exactly what the writer intends. I know that I've skidded in that direction at times. I know, because sometimes following an article I'll get a few letters asking me what did I mean by such and such word or phrase. To clarify the business of technical terms as applied to Fido, let's make a rundown of those words or descriptions most commonly used.

Frequently, when writing about such dogs as setters, spaniels or similar dogs, the word feather has been used in connection with a dog's legs. This is descriptive of the fringe of hair on the rear part of the legs.

The term dewlap describes the loose skin on the underside of the dog's throat. Throaty indicates an excess of such skin. Sway back is applied to any animal, particularly dogs and horses, wherein the back is concave or depressed between the shoulders and hips. Camel back indicates the opposite of swayback. Roach back is when the back slopes down over the hind quarters of the dog, as is seen in the greyhound and whippet. The withers are the shoulders.

When it is said that the dog is out at shoulder it means that the front of the dog is unusually wide at the shoulder, a characteristic which is pronounced in the bulldog. Out at elbows means just what it says; the elbows of Fido jut outwardly, which is a serious defect, particularly among certain of the terriers. In-should-

ered is the reverse, as it brings the pup's forelegs too close together.

In dog circles you'll hear the word pastern frequently used and it denotes that part of the leg between the foot and the first joint nearest the ground. The pad of a dog is the under part of the foot. Breeders of terriers like to have their dogs with cat feet. No, this is not an attempt to be funny; it simply means a bunched-up foot resembling that of a cat. It's desired for style in a dog. To achieve this some breeders keep their show terriers on cinder runways. Not exactly a humane practice, as the intention is to cause the dog to contract its feet in an effort to minimize the cutting of the sharp cinder particles.

A SPLAY FOOT, of course, is one with widely spread toes and a show ring defect in many breeds. The stifle in doggy anatomy is the thigh joint of the hind leg. The hock, the lower joint. You may have heard or read of a dog having cow hocks and this is a good descriptive term mean-

ing that the hocks turn inwardly like those of a cow. This is another serious defect not only in the show ring but among dogs used for the field, as it has been found that dogs with such hocks tire easily when hunting. You may have a dog with dew claws, but don't let it worry you. Breeders often have such claws removed. It is a small extra claw on the inner side of the leg close to the foot. If permitted to remain it constitutes a hazard, especially for dogs used in the hunting field, as the claw too often is torn out when the dog works its way through heavy underbrush. When torn this is extremely painful and sometimes the injured part is difficult to heal.

As all breeders of the setter know, the flag of such a dog is his tail. Frequently the plume of a pooch such as a Pomeranian or Pekingese refers to the tail. The pile of a dog's coat is only a fancy name for the heavy undercoat that some breeds carry. Most dogs, particularly the wire-haired and long-coated varieties, have dou-

(Continued on page 53)

Photo by Phillip Gendreau

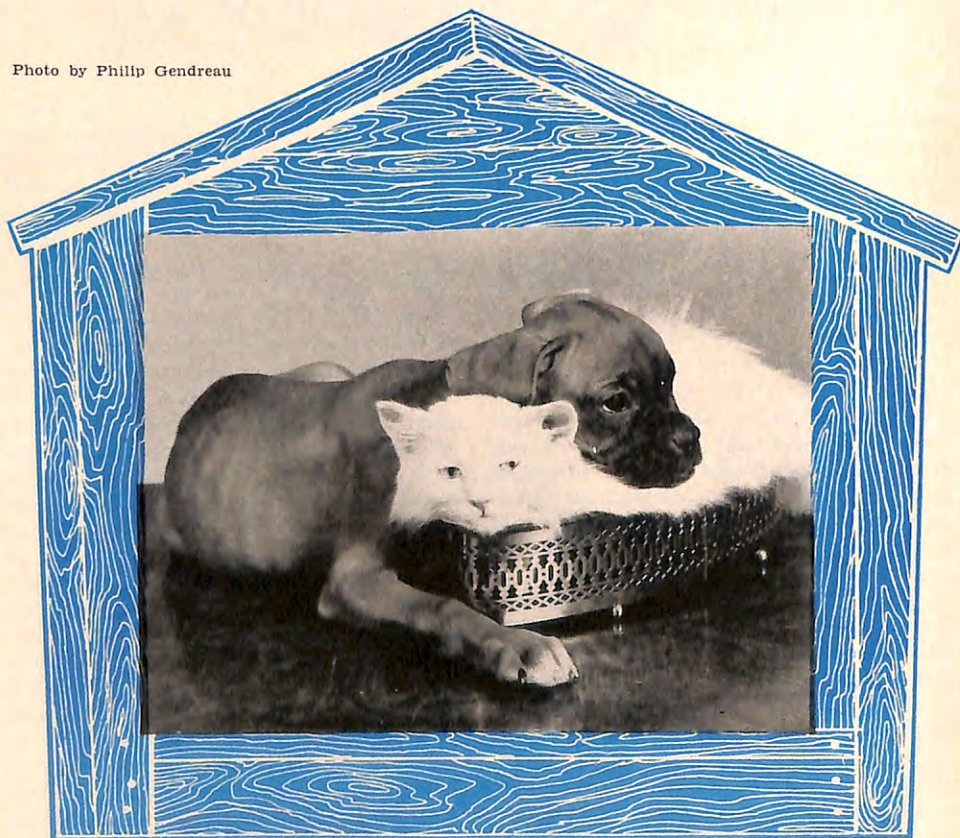

Don't count on a Boxer pup always being this cordial to a Persian cat.

NEWS of the LODGES

Md., Del., D.C. Elks Meet at Annapolis

A very successful two-day, cold-weather conclave of the Maryland, Delaware and District of Columbia Elks Assn. took place at Annapolis, Md., in January, with about 300 Elks and their wives in attendance.

Past Grand Exalted Ruler Dr. Robert South Barrett made the principal address, and D.D.'s Lloyd B. Pahlman and Charles L. Mobley reported on the excellent condition of the 18 member lodges of this very active organization.

The Association approved a resolution to issue a \$50,000 bond to complete the installation of a swimming pool and other improvements of its Barrett Boys' Camp, and Dr. Barrett presented a \$1,000 check for the Assn.'s cerebral palsy program on behalf of the Elks National Foundation, a sum to be matched by a donation from the Tri-State Elks.

At a recent meeting of the Rhode Island Elks Assn. at the home of Woonsocket Lodge, Dr. Edward C. Morin of Pawtucket Lodge, center, was installed as President to complete the unexpired term of the late Richard A. Moran. D.D. Fred Quattromani, right, officiated. At left is Judge James W. Leighton, first Vice-Pres. of the State Association.



Above: When D.D. Jacob Zaslow made his official homecoming visit to Chester, Pa., Lodge he was photographed, fifth from left, first row, with E.R. C. H. Refsnyder on his left, and the other lodge officers, as well as Pottstown Lodge's Drill Team, S.E. Dist. Pres. S. P. Seders, and P.D.D.'s J. V. Hoey, R. T. Frisby, G. M. Kirk, Robert Trucksess, S. G. Sigley, G. S. Mitchell, Jr., J. B. Bozette, B. H. McCoy and H. P. Schmidt, former Grand Lodge Credentials Committeeman.



Above: When Summit, N. J., Lodge celebrated its 1,000th meeting its 1,000th member, Frank Caporaso, III, was initiated with a class of 41 other candidates by its Dist. Championship Ritualistic Team in the presence of his Elk father and grandfather and a number of distinguished visitors including Past Grand Exalted Ruler William J. Jernick and State Pres. Dr. Louis Hubner. Pictured here are, left to right, E.R. Thomas J. Liddy, Frank Caporaso, I, Frank Caporaso, II, and Frank Caporaso, III, Mr. Jernick and Program Chairman William B. Gannon.

Below: In cooperation with the local Park Recreation Commission, Nashua, N. H., Lodge is assisting in sponsoring a Biddy Basketball League. Over 130 applications were received and 11 teams have been organized, all uniformed by the Elks. Committee Chairman Michael Shalhoup is pictured at left, with Park Commission Chairman Oliver J. Dambrose, second from left, and Park-Recreation Director Wm. M. Sweeney, third from left, all members of Nashua Lodge.



Above: Leon Theriault, Sr., left, with his four sons, the first such father-son combination in the membership of Hartford, Vt., Lodge. The young men are, left to right, Leon, Jr., Lawrence, Norman and Ronald.

Right: On Jan. 11th, the 200th birthday of Alexander Hamilton, our first Secy. of the Treasury, the Weehawken, N. J. Elks placed a wreath at the Hamilton Monument commemorating his fatal duel with Aaron Burr. In the foreground, left to right, are P.E.R. Frank Galland and E.R. Edgar Leone. In the second row are Police Chief Edwin Kirk and Elks Andrew Seidel, Eugene Weiblen, Harry J. Ellis and Arthur Buck.





Above: New Jersey's Governor Robert Meyner, left, a Life Member of Philipsburg Lodge, purchases from Bruce Cathcart of Dunellen the first sheet of 1957 Crippled Children's Shields, while P.D.D. Edward J. Hannon, right, Chairman of the State Elks Crippled Children's Committee, looks on. The Campaign, conducted each year by this Committee in conjunction with the State's 81 lodges, enables the Elks to care for and rehabilitate crippled children and sponsor two full four-year scholarships annually in behalf of handicapped children.

Below: In observance of Elks National Home Month, Kokomo, Ind., Lodge invited its P.E.R. J. Ernest Whitley, a guest of the Home for the past three years, to pay a visit to his home lodge and address his fellow members. Pictured on that occasion are, left to right, standing, E.R. Wm. F. Ashburn, Mr. Whitley and Grand Lodge Credentials Committeeman Herb Beitz; foreground: Wm. P. Silis, Joseph Owens and M. E. Smeltzer, candidates initiated that evening as a tribute to the guest of honor.



NEWS of the LODGES



Left: This class was initiated into Coalinga, Calif., Lodge as a tribute to Grand Exalted Ruler Fred L. Bohn.

Port Jervis, N. Y., Elks Welcome D.D. Schoonmaker

D.D. John F. Schoonmaker received a heart-warming welcome from the members of Port Jervis Lodge No. 645 on his homecoming visit there. Highlighted by the presence of Hon. John F. Scileppi, former Chief Justice of the Grand Forum, the festivities were opened with a banquet for the honored guests and P.E.R.'s of the host lodge.

Other dignitaries on hand for this gala program included Past State Presidents James A. Gunn of the Grand Lodge Auditing Committee and Franklin J. Fitzpatrick, Director of the Elks National Convention Committee, and State Vice-Pres. L. P. VanDerberg.

Among the many well-wishers in attendance were representatives from Newburgh, Kingston, Middletown, Liberty, Ellenville, Catskill and Haverstraw Lodges.

Donora, Pa., Lodge Opens New Home

Ceremonies marking the grand opening of the new home of Donora Lodge No. 1265 were held over a three-day period in November, with Grand Secretary Lee A. Donaldson as a special guest.

The celebration began with a banquet at which Mr. Donaldson was the principal speaker, introduced by P.E.R. George O. Frazier as Toastmaster. Other guests included D.D. Floyd N. Dunmire. Dist. Pres. W. Franklin Westcoat, Past State Presidents Wm. D. Hancher and Walter Urben, P.D.D. G. E. Koedel and Charter Members W. Scott Carroll and Kimmel Thomas.



Photographed when East Liverpool, Ohio, Lodge welcomed a class of ten in honor of State Pres. Herschel J. Deal are, first row, the candidates and Mr. Deal; second row, E.R. William Wimmer and his officers, and third row P.D.D.'s William Robinson and T. F. Maley.



Minot, N. D., Lodge officers and the 14-man class they initiated in honor of D.D. Arnold Livdahl. This lodge won first place in the State with a net gain of 108 members for 1955-56.

All three events were well attended by both local Elks and visitors from various lodges of the district. Entertainment was furnished by the Home Towners Quartette, with Ronald Morgan as soloist, accompanied by pianist Wallace Hirsch.

Muscatine, Ia., Lodge Pays Tribute to Arthur Umlandt

Giving evidence of their pride in their P.E.R. Arthur Umlandt as Vice-Chairman and Approving Member of the Board of Grand Trustees, the Elks of Muscatine Lodge No. 304 held a special meeting in his honor, attended by 300. On this occasion a class of 49 candidates was initiated as a tribute to the Grand Trustee.

D.D. Dr. William H. Ward, and President Robert Davis and Vice-Pres., S.E., Harry Harder of the Iowa Elks Assn. were on hand for their official visit to this lodge. Joining these officials in honoring Mr. Umlandt were delegations from Iowa City, Cedar Rapids, Davenport, Clinton, Fort Madison, Burlington and Waterloo, Iowa, Lodges, and from Moline, Illinois.

Right: Photographed when State Pres. Charles C. Bowie paid his official visit to Big Spring, Tex., Lodge were, left to right, Dist. Vice-Pres. John Poole, Senior Past State Pres. Dr. Harry A. Logsdon, Mr. Bowie, a member of the Grand Lodge Youth Activities Committee, State Assn. Secy. and Past Pres. H. S. Rubenstein and D.D. W. C. Ragsdale.



When Daniel V. Crosta, No. Cent. Dist. Vice-Pres., made his home-coming visit to Newark, N. J., Lodge, he was photographed, second from left foreground, with State Pres. Dr. Louis Hubner on his left, and the officers of Newark Lodge.



Pictured on Phoenix, Ariz., Lodge's second annual "Government Night" when all Elks in Municipal, County, State and Federal service are guests of honor were, left to right, Fire Dept. Chief Harold Dean, Pres. L. Cedric Austin of the Ariz. Elks Assn. and Supt. of the local Parks and Recreation Dept., Justice Dudley W. Windes of the Arizona Supreme Court, U. S. Representative John Rhodes and P.E.R. Alex W. Crane, Chairman of the Committee which handled the program.



Officers of Rochester, Minn., Lodge and local Eagles Lodge officials confer on plans for the very successful 2nd Annual Intra-Fraternal Party held at the Elks lodge home. Two events are held annually, with each group alternating as hosts. Seated, left to right, are Eagles State Publicity Director Joe Neuman, Elk Secy. L. R. Benson, Eagles Secy. L. L. Stoddard; standing: E.R. Dr. James E. Trost, local Eagles Pres. Elde Gillespie and L. N. Haggerty, Minn. Elks Assn. Welfare Visitor.



Photographed at the speakers' table during the banquet celebrating the opening of the new home of Donora, Pa., Lodge are, left to right, D.D. Floyd N. Dunmire, Grand Secretary Lee A. Donaldson, General Chairman W. M. Lytle, Toastmaster and P.E.R. George O. Frazier, Chaplain E. C. Cannon, P.D.D. G. E. Koedel, Est. Lead. Knight F. M. Garcia, Est. Loyal Knight C. F. Willebrand and Est. Lect. Knight Anthony J. Mroczka.

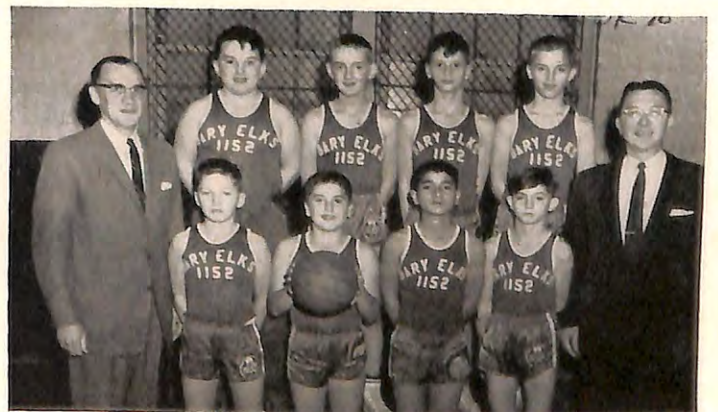

This is the Biddy Basketball Team sponsored by Gary, Ind., Lodge as one of its Youth Activities. At left is Mayor Peter Mandich who tossed the first ball at the opening game and at right is E.R. George H. Smith. These youngsters compete in a 16-team league composed of boys from 9 to 12 years of age. Sam Polly, a member of Gary Lodge, is State Director of the Biddy Basketball Program.

GO PLACES
LEARN ANOTHER LANGUAGE
SPANISH (American or European) • FRENCH (European)
GERMAN • JAPANESE • RUSSIAN
any of 34 languages available
by **LINGUAPHONE**

IN 20 MINUTES A DAY

AT HOME you learn by listening to life-like, conversational recordings. You hear 8 to 12 of the world's best native language teachers speak. You understand YOU SPEAK! World-wide endorsement. Write for FREE Book and information on FREE Trial.

LINGUAPHONE INSTITUTE
T-291-037 Radio City, New York 20, N. Y.

Please send me: Free Book Details on FREE Trial. No obligation, of course.

My language interest is.....

Name.....

Address.....

City..... Zone..... State.....

World's Standard Conversational Method For Over Half a Century

YOUR OLD FUR COAT INTO NEW CAPE, STOLE!

STYLE #55

\$22.95 COMPLETE

ORDER BY MAIL 2-3 week delivery

Send for FREE Style Book

I. R. Fox, fur remodeling specialist, re-styles your old, worn fur coat regardless of condition into glamorous 1957 cape or stole. One low price, \$22.95 complete! This low, low price includes cleaning, glazing, repairing, lusterizing to new sheen, remodel completely, plus a lovely NEW LINING and INTERLINING & Monogram at no extra cost. The thrilling result—a luxuriously beautiful cape, stole or jacket. **SEND NO MONEY!**

Just wrap up your old fur coat, mail it to us now. Send your dress size and height on postcard. Pay postman \$22.95 plus postage when new cape arrives. Or send for FREE Style Book now! Many different styles to choose from. Write:

I. R. FOX, 146 W. 29th ST., DEPT. H-30, N. Y. C. 1, N. Y.



Kills Fleas and "B.O."

"It's wonderful—kills fleas and doggy odor while I snooze. I love its cedar aroma, its clean comfort." Protects children. Stops scratching. Ends all struggles with messy powders, sprays. Keeps pets off chairs, sofas. No more dog hairs. Pleasant in any room. Economical, long-lasting. Flea-Scat-Pad, 15x28 in., \$3.49. Super size, 28x36 in., \$4.98. Kitty Cootie-Chaser the pad for Cats, 14x18 in., \$2.49. Send check or M.O. and we pay postage. Money-Back Guarantee.

Sudbury Laboratory, Box 16G, Sudbury, Mass.

Early American
MINI-BLACKBOARD

Designed in authentically reproduced Early American style. Its elegance, simplicity and great utility value makes it a must for any home. Crafted in selected Knotty Pine with Turned Wood Knobs. Its soft Antique Finish brings out its true beauty. The Blackboard, measuring 7 1/2" x 7 1/2" is ideal in Kitchen for shopping lists and brief reminders, in the play-room for score keeping and noting your favorite TV and Radio programs. An extra long drawer 3 1/2" x 3 3/4" x 7 3/4" may be used for scratch pad, chalk, keys, or as a catch-all, etc. Drawer may also serve as planter by lining it with home-type aluminum foil. Overall size 12 1/2" high x 8 3/4" wide x 4" deep. Only \$5.45 ppd.

Send Check or M.O. Money Back Guarantee.

FRONTIER PRODUCTS, Dept. 1003
P.O. Box 441 Hicksville, New York

Elks

Family



SPARKLING with brilliance that rivals a diamond's, the Kenya Gem is one of the scientific miracles of the century. Here, it's shown in a lady's Duchess Ring—a full carat in a graceful 14K white or yellow gold setting. Only \$54. Send for free illustrated Kenya Catalog "E" showing dazzling rings for men and women. Kenya Gem Corp., Philadelphia 44, Pa.



TINKLING EARRINGS are shaped like tiny cow bells and because they warn one of the wearer's approach, the Indians who designed them, call them "Mother-in-Law Earrings". Draw your own conclusion. In sterling with turquoise-blue stone, \$2.95 a pair, ppd. Plain sterling, \$1.95. Specify screw back or pierced. Old Pueblo Traders, Box 4035, Dept. EM, Tucson, Ariz.



9-MAP LIBRARY includes individual wall-size maps of U.S., Canada, Asia, Africa, Europe and Near East, North America, So. America, Australia, and the World, on heavy duty stock in full colors. Each map, \$1.00; 3 for \$2.75 ppd. All 9 maps in Book-Style Case with index and reference data, \$9.75 ppd. Terry Elliott Co., Dept. MP-153, 135 E. 44 St., New York 17, N.Y.



EASTER-COLORED PLAY EGGS of unbreakable polyethylene come apart in the middle, each revealing a 2" plastic chick in a contrasting color. Eggs in assorted colors come in a real half-dozen cardboard egg carton. For something a mite different in Easter toys, this gets our vote. \$1.00 the set, ppd. Miles Kimball, 99 Bond Street, Oshkosh, Wisconsin.

Merchandise shown on these pages can be ordered direct from the companies listed. Enclose a check or money order.



Housebreak Your Dog Easily!

No more ruined carpets, no more spanking puppy! Just put two drops of HOUSEBREAKING SCENT on puppy's newspaper, box or on the grass and he knows that's the spot! You can completely train most mature dogs and puppies with one bottle or less. *Guaranteed to do the job or your money back!* Only \$2, postage paid. Order HOUSEBREAKING SCENT direct by mail from Sunset House, 829 Sunset Building, Hollywood 46, California.



SOLDIERS • COWBOYS • FIREMEN

Thrill your child with this amazing set. Boys and girls can make thousands of exciting combinations with the 103 pieces. They dress and undress the eight 2 3/4" figures with authentic Soldier, Cowboy and Fireman equipment in miniature. Beautifully realistic in safe, unbreakable polyethylene—this colorful set is perfect for many happy play hours. Order this treat for your child today!

103 Piece Set **\$1.25 ppd.**

RAJAH ENTERPRISES, Dept. EA, Palisade, New Jersey

Shopper

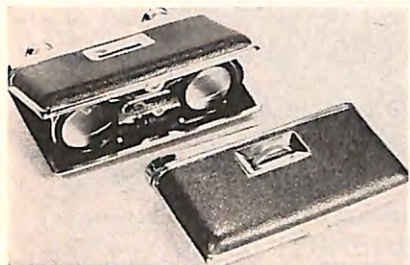

FOLDING OPERA GLASSES fit in pocket or purse to be easily available for use at the theater, sporting events, etc. At a touch of your hand, cigarette-size case snaps open and glasses are ready to use. 2.5X magnification. Leather-covered with nickel plated trimming. 4 1/4" x 2 1/2", only 3/4" deep. \$5.95 ppd. Medford Products Inc., Dept. E, Box 39, Bethpage, N.Y.



HERE COMES PETER, proudest bunny in the Easter Parade, marching and beating his drum to herald the approach of spring. This cuddly bunny walks and beats his drum as his eyes light up . . . all by remote control so your youngster can sit back and watch him perform. 14" tall, battery-operated. \$3.95 ppd. Harrison Products, Dept. E, Box 201, Bethpage, New York.



LAMPS BECOME LOVELIER when you add these new solid brass Finials of exclusive design. Unscrew the plain ones you now have and replace with the splendid American Eagle or the proud Scottish emblem. Thistle in a Wreath. Eagle is 4" x 4"; Thistle, 3 3/4" x 1 3/4" (overall sizes). Each, \$2.95; pair, \$5.50 ppd. Mono-Art, 50 Delancey St., Dept. E, New York, N.Y.



POP-UP PHONE INDEX with Magnetic Mechanical Pencil. Just slide the tab to the letter you want, press, and up pops the cover, revealing the page of listings under that letter. Matching mechanical pencil clings securely to the cover so it's always at hand when you need it. \$1.75 per set ppd. World Wide Industries, Dept. EK-2, 123 Mercer St., New York 12, N.Y.

Except for personalized items, there is guaranteed refund on all merchandise returned in good condition within 7 days.

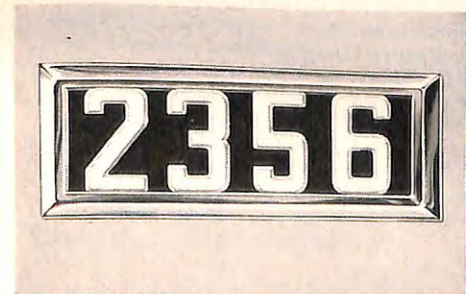

HOUSE NUMBERS

Gleaming brass frame holds three-inch raised numerals. Rustproof—lasts the life of your home! Size: 5" x 12 1/2". Smart modern design . . . easily read; perfect gift. Install instantly with 2 screws provided. Specify numbers desired. Only \$2.95 ppd. Money-back guarantee.

NUMBERS INC., Dept. E
3035 S. Robertson Blvd., Los Angeles 34, Cal.



CROSSWORD PUZZLE DICTIONARY — \$1

At last — a dictionary full of those obscure words you find in crossword puzzles! Completely comprehensive, it has 20,000 words and 50,000 answers used in puzzles — many not usually found in regular dictionaries. Send for this book and you'll never get cross again trying to find a crossword! Clearly indexed. Good clear type. Great boon to puzzle fans. *You must be pleased or your money back!* Only \$1, postage paid. Order CROSSWORD DICTIONARY direct by mail from SUNSET HOUSE, 831 Sunset Building, Hollywood 46, California.



Easy as A-B-C



Be Your Own MUSIC Teacher

LEARN AT HOME THIS MONEY SAVING WAY

Simple as A-B-C. Your lessons consist of real selections, instead of tiresome exercises. You read real notes—no "numbers" or trick music. Some of our 900,000 students are band LEADERS. Everything is in print and pictures. First you are told what to do. Then a picture shows you how. Soon you are playing the music you like. Write for big 36 page illustrated Free Book. Mention your favorite instrument. U. S. SCHOOL OF MUSIC, Studio A1053, Port Washington, N. Y.

FREE BOOKLET



WIGWAM WEDGE MOCCASINS.....\$5.95

of glove-soft, smooth, washable calfskin, they cuddle your feet and make walking a pleasure. Built-in wedge heel. 5 lovely shades: White, Natural, Turquoise, Red, Charcoal—with intriguing pitwheel bead design. Sizes 3 thru 10, narrow and medium—1 1/2 sizes too. . . . \$5.95. Send cash, check or m/o. For COD's send \$2 deposit.

OLD PUEBLO TRADERS Box 4035, Dept. WEL, Tucson, Ariz.

SHOE SHINE KIT

E-Z Shine Holders are made of strong aluminum. Detach from wall bracket. 3 changeable toe plates for men, women and children (for all size shoes). Chrome-like finish. C.O.D.'s pay postage. Look sharp at low cost. Guaranteed to give long, hard family usage.

Penna. residents add 3% sales tax



A useful gift for all occasions

\$2.95

WAYNE Mfg. Co.

WAYNE 2, PENNA.

FREE CATALOG!

BUY GENUINE

Diamonds

From New York's Leading

DIAMOND SPECIALIST
SAVE UP TO 50% AND MORE

Buy For Cash or Easy Credit PLAN

Tremendous savings on diamonds from unredeemed loans, bankruptcy sales and other below market sources. All set in smart brand new 14 kt. gold & platinum modern mountings. One of the world's largest selections. Every diamond graded according to nationally accepted system. Grading explained in catalog. You are 100% protected by a SWORN BOND guaranteeing quality and 10 DAY UNCONDITIONAL MONEY BACK GUARANTEE. Easy payment lay-away plan, and . . . see-before-you-buy plan available. Send coupon for FREE CATALOG. Established 1882. Our references: your own bank or any mercantile agency. No Salesman Will Call.



KASKEL'S 41 West 57th St. New York 19, Dept. 767-c

Send FREE CATALOG and Advice about DIAMONDS without obligation.

NAME
ADDRESS
CITY STATE

YOUR OLD FUR COAT MADE INTO \$22.95
NEW 1957 CAPE STOLE OR JACKET TAX FREE

MORTON'S RESTYLING INCLUDES: NW LINING • INTERLINING • MONOGRAM • CLEANED • GLAZED

- Morton's is world's largest and oldest one-price fur service.
- Morton's Fur Service is most praised by style magazines.
- Widest choice of styles all \$22.95.
- Whether your coat is outworn or just out-of-style you'll be delighted with Morton's glamorous restyling. Write To:



MORTON'S Dept. 45-C Washington 4, D. C.

Mail Coupon to: MORTON'S Dept. 45-C Washington 4, D. C.

SEND FOR FREE 12 PAGE STYLE BOOK
 NAME: _____
 ADDRESS: _____
 CITY: _____ STATE: _____

For Those Who Do Not Want GREY HAIR

Now Top Secret's amazing scientific formula gives a natural looking color to faded or grey hair... makes you look years younger! Top Secret does not streak or injure hair, does not wash out.



"I noticed results after just a few applications," says Jan Garber, Idol of the Airlines. "Top Secret is easy to use—doesn't stain hands or scalp. Top Secret is the only hair dressing I use."

Time-proven Top Secret has been used by famous personalities for years. Send \$5 (Fed. Tax incl.) for 6 oz. plastic container, convenient for traveling, too. Ppd. No COD's, please. Money back if not delighted with results of first bottle! Albin of California, Room 34, 1401-91 W. 5th St., Los Angeles 17, Calif.



for AULD LANG SYNE

For that worthy member who can point to 25 years of membership in the Elks here is a gift that he's sure to prize highly. Pin, 10 kt gold, splendidly enameled red, white and blue 25 year membership. 10 kt gold plated post and attaching button. Please order by number. 25 year pin No. 3—\$8.25. Price includes Federal tax. For N. Y. City sales add 3% tax. Delivery within 2 weeks. Order TODAY from THE ELKS MAGAZINE, 386 Fourth Ave., N. Y. City 16, N. Y.

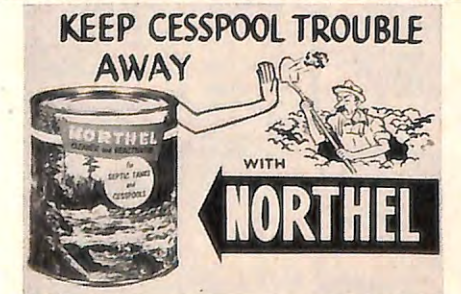

Suburban & Country Dwellers
 NORTHEL Reactivator keeps septic tank and cesspool clean. A bacteria concentrate breaks up solids and grease—prevents overflow, back-up, odors. Regular use saves costly pumping or digging. Simply mix dry powder in water, flush down toilet. Non-poisonous, non-caustic. Guaranteed to reactivate septic tank, cesspool. Six mos. supply (23 ozs) only \$2.95 ppd. Northel Distributors, EM-3 P. O. Box 1103, Minneapolis 1, Minn.

1000 Name & Address Labels \$1.00



Your name and address printed on 1000 fine quality gummed labels, PACKED IN PLASTIC BOX. Use them on stationery, checks, books, greeting cards, records, etc. Your choice of 3 lines printed on fine quality gummed paper. Six orders for \$5. THIS IS A SPECIAL OFFER. A sensational bargain. Ideal for gifts. Makes a wonderful, useful present. Satisfaction guaranteed. HANDY LABELS, 306 Jasperson Building, Culver City 1, California.

★ RETRACT-A-PEN RIOT! ★
 Prices Slashed to New Low!
REFILLS 10 for \$1 only (49c value each) to fit **ALL retractable pens** (except Parker Jotter) Choice of Red, Blue, Black, Green or brand new BROWN ink!
RETRACTABLE PENS 5 for \$1 only (\$1.79 value each) 100 for \$18
 Choice of Red, Blue, Black or Green Ink! Barrels in asst'd colors. Will not leak, smear or transfer. Send check or money order; add 10c shipping charge. Money-back guarantee. Larger quantity and imprint prices on request.
BARCLAY DISTRIBUTORS
 Dept. 620, 86-24 Parsons Blvd., Jamaica, N. Y.

.45 COLT BRAND NEW
AUTOMATIC MODEL 1911 A-1
\$39.95
 The official sidearm of the U.S. Army, made to highest gov't. specifications. This pistol is the most powerful and popular automatic ever developed. A 74.50 value. Exclusive import. Limited supply—now available—absolutely BRAND NEW, 10-DAY MONEY-BACK GUARANTEE. One magazine included. Extra magazines \$1.50 each.
 TO ORDER: Send check, cash or money order. \$20.00 deposit for C.O.D. Shipped RR exp., F.O.B. Pasadena collect.
 Enclose signed statement "Am not alien, never convicted of crime of violence, am not under indictment or fugitive, am 21 or over." Mass., Mo., Mich., N.Y., N.J., N.C., R.I., Chicago, Omaha, New Orleans, require permits—enclose with order.
THE ELLNER COMPANY
 Dept. Q, 1206 Maple Ave., Los Angeles 15, Calif.

Subscribe to... **Trailer Topics Magazine**
6-Month Trial Subscription \$1

 Discover how you can enjoy every modern convenience in your own home for just pennies a day. Read the true-life stories of those who live in mobilehomes and love it.
Only \$3.00 for 2 years.
TRAILER TOPICS MAGAZINE
 Suite 1502 28 East Jackson Blvd., Chicago 4, Illinois

MEDICATED STICK FOR CORNS, CALLOUSES, WARTS
 Why continue to endure pain and discomfort? Just apply this new medicated stick and in a few days you'll get welcome relief. One application usually does the trick. No cutting, no salves, no mess. Convenient stick form. \$1.00 Postpaid. No C.O.D. Guaranteed, of course.
ELRON, INC.
 225 W. Erie St. Dept. A-261 Chicago 10, Ill.

Elks Family Shopper



DRAFTING SET de luxe: Heavily nickel-plated instruments include 5 1/2" pen/pencil compass with straightening device, 3 3/4" lengthening bar, 5 1/2" divider, 5 1/2" ruling pens, 3 1/2" bows, adjustable pen-pencil divider, interchangeable needle points, etc., all in velvet-lined simulated leather case. 14 pc. set, \$4.98 ppd. Scott-Mitchell, Dept. 51-X, 611 Bdwy., New York 12.



HAUL-A-CAN takes heavy loads off your hands. It'll hold garbage cans, barrels, anything that's large and unwieldy. Of lightweight aluminum, it has comfortable hand grip and rolls easily along on wheels. Adjustable hook grasps tops of cans firmly. 42" long, carries up to 200 lbs. \$2.98 ppd. Elron, Inc., Dept. E, 225 W. Erie Street, Chicago 10, Ill.

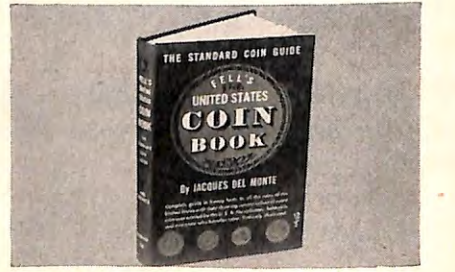

UP-TO-DATE VALUES of all U. S. coins plus a wealth of other data on coin collecting are published in the U. S. Coin Book. You'll learn how to collect them, why they're valuable, how to sell them for the best prices, other valuable information. Covers coins from Colonial times to present. Illustrated. \$2.00 ppd. Fell, Publishers, 386 4th Ave., Dept. E-2, New York 16.

SUGGESTION TO SHOPPERS:
 Save these Shopper pages. They'll make a handy catalog of gift items for all occasions.

Elks Family Shopper

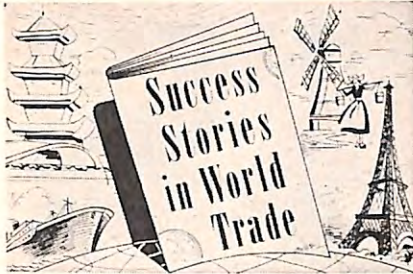

YOU CAN START YOUR OWN import business and benefit from a plan in successful use for 30 years. Free booklet tells you how to make money importing small items for friends or mail order sale; how to get names of foreign suppliers who ship direct. Write for Free Booklet to Mellinger, Dept. G39F, 1717 Westwood Blvd., Los Angeles 24, Calif.



SPARE TIRE COVER keeps your car trunk neat and clean. It has pockets for your tools, clothes, work gloves, flashlight . . . keeps them handy instead of scattered and rattling all over the trunk. It also protects your luggage from getting dirty and scuffed. Fits all size tires. \$1.49 ppd. House of Schiller, Dept. 690-E, 180 No. Wacker Drive, Chicago, Ill.



MAGNETIC ARM holds soap high and dry. Metal plate pressed into soap clings to powerful Alnico magnet in Klick holder. Shaving brush too can be kept dry and handy, held by a metal disc, glued to its handle. Complete with holder, cup and disc, permanent glue and instructions, \$1.00 ppd. Get one for soap, one for brush. Taylor Gifts, Dept. E, Wayne, Pa.

Please mention The Elks Magazine when writing to our Elks Family Shopper Advertisers.

READ THESE FACTS BEFORE YOU ORDER YOUR ZOYSIA GRASS



Meyer Z-52 Zoysia Is The "Plug-In" Grass Perfected by U.S. Dept. of Agriculture

- True Perennial—Never Needs Re-seeding; Ends Seed Expense Forever
- Resists Fungus, Insects, Diseases
- Chokes Out Crabgrass, Weeds & Old Grass
- Mow As Little As 6 Times A Year
- Planted In U.S. Military Bases, Post Office Grounds, Golf Courses, Race Tracks, etc.

AMAZOY is so deep-rooted it stays beautiful through weeks without watering, whether due to water bans, drought or vacationing! Stays rich green through blistering heat; yet won't winter kill. Plugs spread into even, deep-green lawn that resists blight, diseases, etc. Grows so thick it smothers weeds, crabgrass, dandelions, old grass, etc. Even when other lawns burn out this Summer, yours will be lush, green, lovely—the pride of your neighborhood!

GUARANTEED To Grow In Any Soil—Even Beaches!



PLANT AMAZOY PRE-CUT PLUGS IN EXISTING LAWN, NEW LAWN OR NURSERY AREA

Experts Recommend "Plug-In" Planting Because

1. NO WASTE, NO SOD TO CUT, NO SEEDS. AMAZOY comes in extra Large Grass plugs that assure rapid, sure growth. ONLY PLUG PLANTING is recommended by Agriculture Research Serv. of U.S. Dept. of Agriculture, for existing lawns.
2. Just set plugs in ground 1 foot apart, checkerboard pattern. (Easy planting instructions with order.)
3. Soon spreads to cover entire lawn with thick, rich, beautiful turf.
4. Does not require renewal as does a seeded lawn. Perennial. No annual upkeep.

FREE!

Patented Step-On Plugger



For planting and transplanting. Patented design cuts away competing growth as it digs hole for plugs, for faster, surer growth. Order at \$4.95 or FREE with larger orders!

Dept. 411, Zoysia Farm Nurseries

602 N. Howard Street, Baltimore 1, Md.
333 N. Michigan Ave., Chicago 1, Illinois

Order Now From World's Largest Grower—Pre-Season Prices!

100 Large Pre-Cut PLUGS \$5.95

100 Large Pre-Cut PLUGS & PLUGGER \$9.45

300 Large Pre-Cut PLUGS & PLUGGER \$17.45

1000 Large Pre-Cut PLUGS & PLUGGER \$34.95

GUARANTEED TO GROW SAVES MONEY AND LABOR

Amazoy is guaranteed to grow in any soil—hillsides, subsoil, etc. Comes in plugs of rich, original mother earth, as recommended by U.S. Dept. of Agriculture. Soon spreads to cover entire area; YOU CAN THEN TAKE 50 TRANSPLANTS A YEAR PER FOOT. Plugged area soon grows over; provides endless supply of transplants yearly! Any plug failing to grow replaced free.

Plug-In Zoysia Hailed by NEWS-WEEK, LOOK, CONSUMER REPORTS, UNIVERSITIES, ARTHUR GODFREY, etc.

ORDER NOW—CLIP COUPON

DEPT. 411 ZOYSIA FARM NURSERIES
602 N. Howard Street, Baltimore 1, Md.
333 N. Michigan Ave., Chicago 1, Illinois

Please ship me the following order of AMAZOY:

- 100 Plugs \$5.95 100 Plugs & Plugger \$9.45
- 300 Plugs & Plugger \$17.45 1000 Plugs & Plugger FOB Baltimore, Md. \$34.95

If you live west of Miss. River, please add \$1.50 per 100 plugs for special handling and shipping.

I enclose.....check,money order,cash

Name.....
Address.....
City.....Zone.....State.....



ZARI STOLE AND SCARF SET
Direct from India

Pure silk hand-made Zari Stole and Scarf set, in assorted colors Green, Blue, Red, Brown, Grey, White or Black. Wear it as a head or neck piece or drape gracefully around shoulders to accompany any evening outfit. Scarf \$4.50, Stole \$9.00, Combination \$12.50. 15¢ foreign mail fee collected on delivery. If you are not delighted and completely satisfied return article, and purchase price will be refunded. Allow 6 weeks for shipment.

James W. Steward Import-Export 601 Union Ave. S. E. Grand Rapids 6, Michigan



A GIFT SHE'LL TREASURE is this imported set of unusual jewelry. Hundreds of tiny pieces of colored enamel are inlaid to form beautiful pattern of red roses in a jet black background. It's a centuries-old craft in Florence, Italy. Bracelet (6 links 5/8" wide) \$7.50, earrings (also pierced) \$3, the set \$9.50 postpaid (incl. tax). Add 35¢ Air Mail.

Money back guaranteed if not truly delighted.

ALPINE IMPORTS Dept. EL-14, 505 Fifth Ave., NEW YORK 17, N. Y.

7 Power ILLUMINATED LOUPE

A must for every handyman, hobbyist, student



Imagine, a precision-built 7 power magnifier with built-in light so every detail stands out clear and sharp regardless of outside illumination. Coated lens. Battery model. An opening in the housing permits use with other instruments. Lens diameter 13/16". Supplied with linen tester plate for thread counting, which fits into the bottom of the housing.

An absolutely amazing value . . . worth \$4.95 \$9.95 . . . (batteries not included) NOW only

Send Check or M.O. C.O.D. plus fee. Money Back Guaranteed.

SCOTT-MITCHELL HOUSE, INC.

Dept. 51-C, 611 Broadway, New York 12, N. Y.

New! Polished Chrome Plated HOSE SHUT-OFF VALVE

NO TWISTING
NO TURNING



Ideal for

- HAND SPRAYS
- LAWN SPRINKLERS
- BETWEEN HOSES
- CAR WASHERS
- IRRIGATORS

PUSH—water flows! PULL—it shuts off!

No protruding valve handles to dig up lawns or earth, caused by dragging hoses. This new type Hose Shut-off valve shuts water off instantly. No more long walks to and from faucet to start or stop water. Guaranteed leak-proof. Non-corrosive. For use with all types of home and garden appliances, such as hand sprays, sprinklers between water hoses, car washers and irrigators.

\$1.98 SEND NO MONEY. Pay postman \$1.98 plus postage and handling or send \$1.98 and we pay postage.

MEDFORD PRODUCTS

Dept. EL3

Box 39, Bethpage, N. Y.

Genuine
**6 INCH
TAMPA PALMA**
at a **42% saving**
For those who delight in
the flavor of imported
Havana Tobacco
**SMOKE SAMPLE BOX
AT OUR RISK**

We want you to smoke these Tampa Palmas at our risk, and if you don't think they equal any 26¢ Palma on the market, they're "on the house." You're the judge and jury.

One of the largest high-grade cigar factories in Tampa, Florida has a temporary surplus production in their regular 26¢ size. That's why we can offer these Genuine 6 in. TAMPA PALMAS at 42% under the 26¢ price while the quantity lasts.

These are luxury cigars, all 100% long filler, No scraps, No dust. They're extra Mild and Mellow because the imported Havana Wrappers are selected light Claro-Claro color from the Vuelta Abajo district of Cuba.

To make this special value possible they left off the fancy bands, labels and boxes and put the cigars in a lower tax bracket. But all the mildness, flavor and smoking pleasure are exactly the same as the regular 26¢ cigar under the maker's brand name (which we're not allowed to mention). Here's how you save 42%. Send us only one dollar and we'll send you postpaid a sample box of 7 Tampa Palmas, that's 42% under the 26¢ price. Now test smoke as many as you like, if not delighted, return the balance for your dollar back. You can't lose. Sorry only 1 sample box to a customer.

WALLY FRANK Ltd. Dept. P136
132 Church St., New York 7, N.Y.

Send me the sample box of 7 Tampa Palmas, on your money-back guarantee as described above. Enclosed find one dollar. (Please print name and address below)

SWAT!
baseball trainer

Only **98¢**

improve quickly —
IT'S FUN! swell exercise!

TWO-WAY USE! Attach to ground stake or can be swung through strike zone by teammate. Develop form—sharpen your

eye at home. Hit it square and hear the solid *swat!* It's fun! No ball to chase—Returns to position after each swing. Pivots to different positions in strike zone. Improves batting average. Heavy duty. Used by instructors. Satisfaction guaranteed. Send 98¢ to **S & R RESEARCH** Box 72-M, San Gabriel, Calif.



Perfect "GET-WELL" Gifts



BLANKET SUPPORT makes cosy foot free space. With sleep disturbing blanket pressure gone you can stretch and turn freely. Natural sleep comes quickly. Fits all beds. Arms fold down. Enjoyed equally with sheet, blanket or electric blanket. Perfect gift for restless sleepers, arthritics, invalids—\$3.98 plus 25c mail.

Ingenious KNEE LIFT. Cushion slightly flexes your knees for contour chair or hospital bed comfort. Back hips and legs relax, tensions vanish, sleep comes easily—many back and leg aches magically disappear. Air cushioned. Wonderful gift for T.V., bed reader, invalids, pregnancy. Only \$2.98



Immediate delivery, money back guarantee.
BETTER SLEEP, INC.
Dept. 471, New Providence, New Jersey

GROW IN YOUR YARD!

MADE OF EVERLASTING ALUMINUM



PYRAMID STRAWBERRY GARDEN

Adds interest and beauty to your garden. Produces a bigger, better crop. 5 ft. size just right for 50 plants.

Only **\$7.95 ppd.**

SPECIAL! 5 ft. aluminum garden with 50 Superfection everbearing strawberry plants.

Complete . . . Only \$9.95 ppd.

ORDER FROM THIS AD. SEND CHECK OR MONEY ORDER!

MINNETONKA NURSERIES

Dept. E3

Excelsior, Minnesota



FUN FILLED TOILET TISSUE—\$1

Laughin' bathroom tissue will dress up any john with riotously funny sayings! Great for gag gifts. Makes your guests sit up and take notice. A silly saying or racy remark is printed on each sheet with non-irritating ink. "Do it yourself", and a 100 other sayings! Here's a witty way to solve the bathroom reading problem. *You must be pleased or your money back!* 3 different rolls of Tissue for only \$1, postage paid. Order **LAUGHIN' TISSUE** from **SUNSET HOUSE**, 830 Sunset Building, Hollywood 46, Calif.

Elks Family Shopper



ROCK 'N ROLL Wham-O Balance Board is good exercise for the legs and ankles and a riot of fun at parties. The game is to see who can balance the longest . . . and we'd say teetotalers make the best teeterers. It's really instructive in developing a sense of balance too. \$3.50 ppd. Wamo Manufacturing Co., 835 E. El Monte St., Dept. S, San Gabriel, Calif.

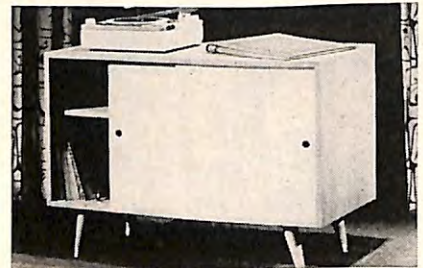

NAME YOUR NEED for storage . . . Sliding Door Cabinet meets it with roomy, dust-free space for serving dishes, Hi-Fi units, records. Solid Appalachian Ash (looks and lasts like oak). Masonite doors are limed oak grained. Adjustable shelf. 40" long, 30½" high, 18" deep. Ready to assemble. \$36.95, exp. chgs. coll. Show-Off Inc., Dept. E, Jamestown, N. Y.



GIVE YOURSELF A BIRTHDAY PRESENT by saving \$100 for your birthday. If it's a year or so off, a quarter a day will do it. If closer, give the fund a little start. Each quarter changes the date and a running total is recorded. Banlok, plain or with "Birthday Bank" in gold, \$2.00 each; 3 for \$5.75 ppd. Leecraft, Dept. ELB, 300 Albany Ave., Brooklyn 13, N.Y.

Free! ISRAEL Stamp Collection

Free Israel Stamp Collection usually selling for \$1.00 and more, this packet of 25 ALL DIFFERENT ISRAEL stamps is yours **FREE!** Stamps from this proud, freedom-loving Nation are sought after the world over. Here is your chance to own a good basic collection including the various ancient HEBREW COIN SETS, 12 TRIBES ISSUE, HIGH HOLY DAYS, RUNNING STAG ISSUE, AIR-POST, and CHILDREN'S ISSUE, Etc. All this is yours, to introduce our bargain approval (returnable) offers. 48 PAGE STAMP DICTIONARY AND GUIDE included Free. Send 10¢ to help cover mailing costs.

STAMP EX CO., Box 47, -ME, White Plains, New York



Please mention The Elks Magazine when writing to our Elks Family Shopper Advertisers.

Elks Family Shopper



REDECORATE AT LOW COST with a Hand-Painted Mural that brings color and life to a drab wall. Action Scene shown would be striking in a den. 3' x 4', \$12.00; 4' x 7', \$18.00 ppd. You can also have a mural custom-made to your own specifications. Shipped rolled, ready to mount or frame. Butler Paper N.Y. Corp., Dept. E, 655 Madison Ave., New York 21, N. Y.



SHAVE 5 to 12 STROKES off your game in one month after reading "How to Play Your Best Golf All the Time" or return it for refund. Famous pro Tommy Armour gives you simple, effective tips on teeing, grip, footwork, waggle, backswing, putting, etc. Sent on 10-day free trial. \$2.95 plus postage. Simon & Schuster, Dept. E, 630 Fifth Ave., New York 20, N. Y.



LIKE KITCHENS WITH CHARACTER? Hang your kitchen tools on this Ox-Yoke Utensil Rack and get set for the flattering comments. It's hand-rubbed knotty pine with black hand-wrought nails for hanging five utensils. Comes with screws for hanging. (Utensils not included). \$2.95 plus 15¢ postage. Laurie & Co., Dept. E, 507 Fifth Ave., New York 17, N. Y.

SUGGESTION TO SHOPPERS:
Save these Shopper pages.
They'll make a handy catalog
of gift items for all occasions.

FAMOUS Monte Carlo STAINLESS STEEL STEAK KNIVES

Nationally Advertised
at \$2.00 Each

10
Year
Guarantee!

NOW
33¢
IN LOTS OF
3 OR MORE

Finest
Korium
Steel!

Gold and Ivory
Hue Handles!

FREE GIFT

CAKE & PIE SERVER

Rich, ornate, exquisitely designed. Yours FREE on any order for 12 knives. Keep it FREE even if you return knives for refund!



10
Year
Guarantee!

First Quality!

We import direct from the Continent in huge quantities, sell direct by mail, eliminate middlemen's profits and needless distribution costs. Result? You get these Monte Carlo steak knives for only 33¢ each! All first-quality! Will give a lifetime of service! Made of finest Korium stainless steel by old world craftsmen in Solingen, West Germany—Europe's famed cutlery center! Can't rust or tarnish, never need sharpening or polishing. Hollow ground, like barber's razor, with serrated edges for faster cutting of thick steaks, roasts, etc. Beautiful gold and ivory hue handles. Perfect for any table setting. Over ONE MILLION already sold. Money-Back Guarantee.

THORESEN INC., Dept. 103-C-89
585 Water Street, New York 2, N. Y.
RUSH Monte Carlo steak knives to me. If not delighted with 10-day home trial, I'll return them for full and prompt refund.

Payment enclosed. Send prepaid.
 Send COD, plus postal charges.
 Send 3 for 99¢ Send 6 for \$1.98
 Send 12 for \$3.96 — Include Free Princess Server mine to keep even if I return knives.

Name
Address
City & State
Zone
Canadian Address: 45 St. James St. W Montreal 1, P.Q.

YOU ARE PROTECTED

by The Elk Magazine itself when you buy through your ELKS FAMILY SHOPPER. Our advertisers are legitimate, reliable mail order firms, committed to refund full purchase price to any dissatisfied customer (personalized items excepted). But—more than that—THE ELKS MAGAZINE takes the ultimate responsibility for seeing that you receive full satisfaction. So, in the unusual event that you have any difficulty with an advertiser, be sure to write the magazine for prompt attention.



NOW IS GOOD TIME TO PLANT
BLUE-GREEN

MONDO "GRASS"

This entire lawn planted in Mondo "Grass" Trade Mark Registration applied for U.S. Patent Office

REQUIRES NO MOWING—MAKES WORLD'S MOST BEAUTIFUL LAWN

Our Blue-Green Mondo "Grass" is described by the U. S. Department of Agriculture as "Ophiopogon Japonicus (formerly called Mondo Japonicus)", is native to Northern China and should withstand severe degree of freezing; drought tolerant, evergreen, commonly called Mondo "Grass." It is a "grass" relative to the lily with paper thin blade 1/16" wide. This sod-forming EVERGREEN, low-growing oriental genus is currently used by many owners of distinctive homes in America for lawn grass. Now we can offer this exclusive Blue-Green Mondo "Grass" at popular prices. SO HARDY IT CAN BE PLANTED ANYTIME, it is recommended for beautiful lawns where mowing is not desired. Blue-Green Mondo "Grass" retains its color the year-round; thrives in shade or sun; extremely hardy, rarely requires watering; fantastically beautiful, drooping low to the ground in weeping style year after year. **REQUIRES NO MOWING AND SHOULD NEVER BE MOWED.** Guaranteed to withstand severe freezing or money refunded. Ideal for heavy shaded areas, dry or wet. FREE folder of testimonials and many photos of Mondo "Grass" lawns sent on request. Mondo is resistant to diseases; insects and animals will not feed on it. Stops erosion; grows compactly, crowding out other grass and weeds; multiplies rapidly, approximately 100 times (10,000%) first year. Enhances property value. So sensational we expect to revolutionize lawn-making. For good coverage first year plant 4" to 12" apart. Numerous rooted blades to sprig. Planting and culture instructions with each order. Shipped now or when desired. Remittance with order. Shipped prepaid. **MONEY-BACK GUARANTEE**; if not completely delighted you may return at once for refund. Open account to A-1 rated firms buying 1,000 sprigs or more. FOB, Biloxi. Distributors wanted everywhere.

ORDER TODAY . . . YOU CAN'T LOSE!

Sprigs packed in damp moss.
Guaranteed to grow or we will replace.

25 Sprigs.. \$2.98	1,000 Sprigs \$79.00
50 Sprigs.. 5.00	5,000 Sprigs
100 Sprigs.. 9.00	or more
500 Sprigs.. 40.00	per 1,000..50.00

Mondo Grass & Nursery Co., Dept. E, Biloxi, Miss.
Please send prepaid Sprigs of Mondo "Grass",
for which I enclose \$.....
Name
Address
City State



EASY WAY TO FILE CHECKS—\$1

CHECK-SAFE holds 800 cancelled checks, a 5-year record. Keeps them safe, clean—always in place for easy reference. Helps you budget. Keep a check on your personal spending habits. Cancelled checks are your best receipts—they act as important records. Essential for income tax purposes. Green Ripplette covered box, gold stamped. 7 1/4" x 5" x 3 1/4". Tab index dividers included. *Satisfaction guaranteed or your money back!* Only \$1, postage paid. Order **CHECK-SAFE** direct by mail from **Sunset House, 810 Sunset Building, Hollywood 46, California.**

7MM MAUSER 6 CARBINES

GUAR. GOOD CONDITION
\$19.95

6 SHOT BOLT ACTION MOD. '95

One of the world's most popular hunting calibers in a powerful military carbine. Light, fast, extremely accurate with the famous trouble free Mauser action. **SOFTNOSE HUNTING AMMO.** available everywhere—made by Rem., Win., Peters, Western. Bore and outside guar. good. This model, seldom seen on the market, is a bona fide collector's item. Our exclusive import. Made prewar for Mexican Army. All milled parts. **TO ORDER:** Send check, cash or M.O. 1/2 dep. for C.O.D. Calif. res. add 4% state tax. Shipped R.R. Exp. F.O.B. Pasadena. 10-day money back guarantee.

GOLDEN STATE ARMS CORP., 409 Armory Bldg.
1165 East Colorado Street • Pasadena, California

Guaranteed VERY GOOD Cond. \$27.50
FOR HINGED FLOOR PLATE ADD \$5.00

PROTECT YOUR CHILD

FROM WET BEDS with STAYDRY* PANTIES

Protect your child—day and night—from unhealthy wet clothes and bedding. Staydry is the all-in-one panty recommended by many leading doctors as the solution to this embarrassing problem.

NOT A DIAPER

These well-fitting panties of fine, non-toxic plastic are lined with highly absorbent material for complete safety. Washable, they may be boiled and bleached. Economical Staydry frees you from the needless mess and expense of rubber sheets, extra sheets and enormous laundry bills.

Guaranteed by Good Housekeeping

RECOMMENDED BY PARENTS



\$1.69

Perfect for invalids—wonderful for adults with this distressing problem.

INFANTS:	
Med., Lg.	\$1.69
Extra Lg.	\$1.98
WAIST SIZES:	
18, 20, 22	\$2.98
24, 26, 28	\$3.98
30, 32, 34	\$4.98
36, 38, 40	\$5.98

Give exact waist measurement in inches.

FREE Booklet on Bedwetting.

Money Back Guarantee in 10 Days

*Reg. U. S. Pat.

JOLAN SALES CO.
Newburgh, N. Y.

JOLAN SALES CO. Dept. E-1 Tel: 1288
Fostertown Road, Newburgh, N. Y.

Please send me Staydry Panties

Waist Size Price

C.O.D. Check M.O.

Name

Address

City State

Jung's GIANT GLADS



WILL AMAZE YOU WITH THEIR SIZE AND BEAUTY. SPIKES 3 TO 4 FEET TALL. Bulbs guaranteed to bloom.
50th ANNIVERSARY SPECIAL!
49c VALUE ONLY 25c

As a special inducement for you to plant Jung's famous Seeds, Bulbs and Plants, we will send you 6 of these grand Gladioli, one Flaming Red Begonia and a pkt. of the Brilliant Blaze Zinnia, the "All American" Winner, all for 25c. We will also send, if requested, our color catalog of bargains in Seeds, Bulbs, Plants, Shrubs. Premium Coupon in every catalog.

J. W. JUNG SEED COMPANY

Dept. 64 Randolph, Wisconsin

A GIFT HE'LL ALWAYS CHERISH



Now comes the time of the year when the Exalted Ruler becomes Past Exalted Ruler and as customary in many lodges a token of appreciation is given to the outgoing official. Few, if any, departing gifts will be more valuable than an official Past Exalted Ruler's pin shown above. Here is a pin of superb craftsmanship, 10k gold with gold plated post and attaching button, beautifully enameled red, white, and blue. As shown, bearing Past Exalted Ruler's designation; this pin, No. 11, \$12.50.

11A same as above, but with one 5 pt. diamond.....\$46.00.

11B with one 10 pt. diamond \$70.00.

Send check or money order to:

THE ELKS MAGAZINE, 386 Fourth Ave., New York 16, N.Y.

FREE! U.S. STAMPS



Sensational Get-Acquainted Offer! Get this scarce genuine postage stamp, as illustrated, picturing first U.S.A. (issued in 1847!); **PLUS** big collection of 30 all-different United States; 19th century, valuable \$5 stamp, etc. . . . **PLUS** packet beautiful Commemoratives including '93 Columbian, Boy Scouts, Wild West, many others. **EXTRA:** other exciting offers; 64-page Collector's Guide; Big Bargain Catalog of U. S. Stamps.

SEND 10c for mailing costs. ACT NOW!
HARRISCO 3440 Transit Bldg., Boston 17, Mass.

SEWS LEATHER AND TOUGH TEXTILES LIKE A MACHINE

With **SPEEDY STITCHER** Automatic Sewing Awl, anyone can quickly and skillfully sew or repair anything made of **LEATHER, CANVAS, NYLON, PLASTIC,** or other heavy materials. Sews firm, even lock-stitches like a machine. Gets into hard-to-reach places. Specially made for heavy duty sewing on **LUGGAGE, FOOTWEAR, RUGS, AWNINGS, SAILS, SADDLERY, UPHOLSTERY, OVER-ALLS, AUTO-TOPS, SPORTS GEAR,** and other tough sewing jobs. Here's the handiest tool you'll ever own. Will save you many times its small cost. Comes ready for instant use complete with bobbin of waxed thread and 3 different types of diamond-pointed needles. Easy-to-follow directions will make you an expert in minutes. Extra needles and waxed-thread always available. Save money! send \$1.98 for postpaid delivery. If C.O.D., \$1.98 plus postage. **MONEY BACK GUARANTEE.**



ONLY 1.98

SPORTSMAN'S POST, 366 Madison Ave., Dept. A-398, New York 17

Elks Family Shopper



EARRING WARDROBE of 18 changes to match every costume. One pair of clip-back magnets holds all the pearl buttons fast. Set includes 6 pairs of colorful buttons, 2 pairs of Halos, one of gold-like finish, the other silver-type finish and rhinestone-studded. Wear buttons in daytime, add halos for evening. Set, \$4.95 ppd. Lynn Denise, Dept. E, 246 5th Ave., New York 1.

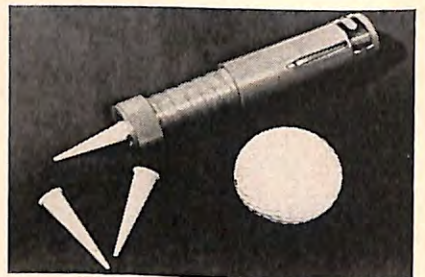

DO YOU HAVE A HARD TIME teeing up on hard ground? You won't if you use Tee Toter. Its adjustable barrel allows each tee to be driven to same height. Slight downward pressure on turf ejects tee. Strong clip holds Tee Toter to bag or cart. Filled with 9 tees, \$2.75 ppd. Extra tees, 25¢ a doz. Camalier & Buckley, Dept. E, 1141 Conn. Ave., N.W., Washington 6, D.C.

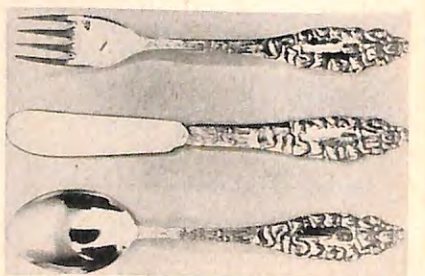

CHILD'S SILVER SERVICE. For your heir or heiress apparent, here's a gift to be cherished and passed on to the next generation. Swedish Silverplate in the distinctive Princess Pattern, lovely enough for an heirloom; each piece is 6". Set of three, \$3.50. Pay postman 15¢ delivery fee. The Root Company, P. O. Box 3126M, Santa Ana, California.

Please mention The Elks Magazine when writing to our Elks Family Shopper Advertisers.

Soviet Aggression

(Continued from page 9)

use it whenever necessary deprives us of constructive action in our own interest.

There are several sections of the Charter, however, which provide directly for adequate relief from Soviet steamroller tactics. There is, for example, Article 27 of the Charter, which provides for voting methods to be used in the Security Council. Paragraph 3 of that article says: "Decisions of the Security Council . . . shall be made by an affirmative vote of seven members including the concurring votes of the permanent members; provided that . . . a party to a dispute shall abstain from voting."

Here is a paragraph of the Charter that clearly says what it means. If you are a party to a dispute that comes before the Security Council, you cannot vote on it. But the Russian Communists, having sent tanks, heavy guns and a dozen divisions of armed troops shooting their murderous way through Hungary, declare that they are not party to any dispute in that country. They came there, they say, because the Hungarian Premier, Janos Kadar, asked them to. As a matter of fact, they declare, there is no dispute in Hungary, but only another of those bourgeois riots stirred up by the Western imperialists. And the United Nations and its individual members would be well advised, they warn, to refrain from criticizing the Soviet Union and to keep from "interfering in Hungary's internal affairs."

The General Assembly of the United Nations, spurred on by world-wide horror of Soviet ruthlessness and brutality, adopted several resolutions declaring that the U.S.S.R. had violated Hungary's sovereignty and demanding that Soviet troops get out of Hungary. This, *per se*, labelled the Soviet Union an aggressor in Hungary. The nature of the resolutions made clear what the Kremlin had ordered its troops to do: to destroy the Hungarian government of Premier Imre Nagy by force, to kidnap Nagy and ship him out of the country (or, possibly, to kill him), and then to set up the Soviet puppet, Janos Kadar, in his stead, under the muzzles of Soviet guns.

WHAT ACTUALLY HAPPENED?

And so, here we are. The General Assembly says the Soviet Union is an aggressor, and thus a party to the Hungarian dispute. This automatically deprives the Soviet Union of the right to vote in the Security Council on any proposal for disciplinary action with regard to the Soviet's action in Hungary. The Soviet Union, in other words, may not use its veto. But what actually happened? The Soviet Union laughed in the face of the United Nations, vetoed action by the Security Council, kept its troops in Hungary, continued to deport Hungarians to Siberia, and remained a member of the United Nations "in good standing."

What is wrong with the United Nations

that it seems unable to enforce upon its own members compliance with rules which the members themselves agreed to abide by? We are speaking now not of direct action against aggression, but only of enforcing parliamentary obedience in the U. N. to the rules set down in the Charter. For example, prohibiting the Soviet from using the veto in the Security Council on the matter of Hungary.

Actually, nothing prevents adequate action by the members of the United Nations except lack of will to face up to the situation. Are we afraid to say *nyet* to the Soviets? Are we afraid of disturbing Khrushchev's aggressive policies? The fact is that if the non-Communist nations just once would require that the Reds live up to their legal commitments on the U. N. floor, it would restrain Mr. Khrushchev from again threatening "to bury us," and it might just possibly sober up the rest of the maniacs in the Kremlin.

Now suppose one of our good-willed, but weak-kneed, friends tells us: "You can't make the Russian Communists comply with the rules no matter what you vote and no matter what resolutions you adopt." What do you do then?

PROVISIONS ARE THERE

The answer to that doesn't seem to be too difficult to decide. Again, it takes a little more intestinal fortitude than some of the delegates to the United Nations have exhibited so far. For the Charter makes adequate provision for the kind of action that should be taken under these circumstances, and that is: Suspend the Soviet Union until such time as it acts like a civilized nation.

There would be no need to take advantage of legal loopholes in the Charter, as the Communists are constantly on the alert to do, or to fight their veto with our own. Article 18 of the Charter says: "Decisions of the General Assembly on important questions shall be made by a two-thirds majority of the members present and voting. These questions shall include: recommendations with respect to the maintenance of international peace and security, the election of the non-permanent members of the Security Council, the election of the members of the Economic and Social Council, the election of members of the Trusteeship Council . . . the suspension of the rights and privileges of membership, the expulsion of members, questions relating to the operation of the trusteeship system, and budgetary questions."

And this means, if it has any meaning at all, that the General Assembly has the right, by a two-thirds vote, to suspend the Soviet Union or to expel that lawless mischief maker from membership in the United Nations.

The Soviet Union is well aware that the United Nations provides ways and means of clipping its unruly talons if only the civilized member nations muster sufficient will power to exercise the rights that are theirs under the Charter. Calculating shrewdly that such a time will eventually

FREE

FOR YOUR ORGANIZATION

Useful Products

Like These

JUST BY SELLING AS FEW AS
28 BOXES OF GREETING CARDS

48-CUP Drip-O-Lator COFFEE URN

Large quantity coffee brewing made simple and easy. Aluminum Urn is graduated to brew 24, 36, or 48 cups of delicious coffee and keep it hot until served. Electric base. Yours for selling only 48 boxes of Lincoln Cards. (72-cup size also available).

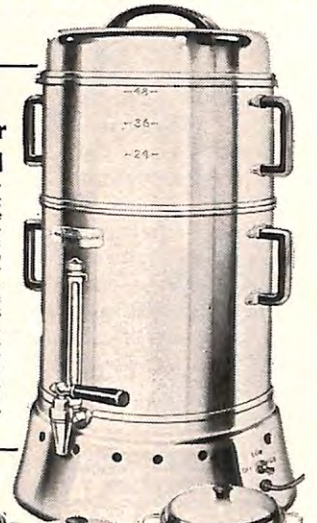

SET OF 6 ALUMINUM COOKING POTS

6 heavyweight-gauge Aluminum Pots for quantity cooking or canning. Choice of 6-qt. or 10-qt. size. Yours for selling as few as 28 boxes of Lincoln Cards.

Yes, it's true! You can get this handsome Coffee Urn or wonderful set of Aluminum Pots—or many other useful products your Organization needs—without taking a single penny out of your treasury! How? It's simple—just sell gorgeous Lincoln Greeting Cards . . . and that's easy to do! Once your friends, relatives, neighbors, members actually see these beautiful cards—they're sold! Cards for every occasion . . . birthday cards, anniversary, get-well, friendship, congratulation cards . . . all so handsome they'll be remembered and treasured through the years! See for yourself how easy it is to sell Lincoln Greeting Cards—how easy it is for your Organization to get useful products. FREE. Just mail coupon for details and samples of cards.

LINCOLN ASSOCIATES, Dept. EM-3
1 Marbury Terrace, Boston 30, Mass.

Please rush me full information on how my Organization can get useful and valuable items—FREE—by selling Lincoln Greeting Cards. Also include samples of Lincoln All-Occasion Cards on approval. I understand I am not obligated in any way.

Organization.....
Address.....
Your Name.....
Address.....
City..... Zone..... State.....

come, the Soviet is now beginning to make plans to circumvent possible action against it in the future. This has taken the form of trying to make package deals for admission of new members.

Moscow would be very happy to permit the West to invent fictitious countries and to have them apply for membership in the United Nations, if the West, in exchange, would approve of the same action by the Soviet Union. The Soviet was bitterly disappointed when its puppet nonentity, Outer Mongolia, failed to gain admission in the last "package deal"—a deal in which moral, ethical and legal principles were abandoned for the sake of expediency.

Why is the Soviet anxious to make package deals for the entrance of new members to the United Nations? Actions of the General Assembly that are important usually require a two-thirds vote instead of a simple majority. The more members of all kinds that are admitted to the U. N., regardless of whether they are genuinely independent nations, Soviet satellites, or half countries of states which Communist aggression has truncated, the less possible it becomes for the democratic nations to muster a two-thirds vote. And the more chance there is for the Soviet Union to defeat world progress toward universal peace, security and human freedom.

WHAT COULD HAPPEN

If we continue as we are doing now, we should be able to foresee the pattern for the future. Soviet money, Soviet weapons, Soviet agents, and Soviet subversion, could enable Soviet sponsored puppets to take the reins of power in one or more of the weak Arab states of the Middle East. The puppets, who would be unable to hold power for twenty-four hours without Soviet troops and Soviet guns (puppets such as Kadar in Hungary) could then call for Soviet assistance. Soviet armies would flood the area, as they did in Hungary, and murder unarmed citizens. The Soviet Union would then declare that neither the United Nations nor any individual nation had any right to interfere in the internal affairs of the countries whose governments would thus be destroyed, and whose people would be made slaves under Soviet controlled puppets.

Where military resistance is anticipated, the Soviet Union would not officially declare war. That would bring large scale retribution from the United States as well as from our allies. They would, instead, send "volunteers" by the thousands, as the Red Chinese did in Korea only a few years ago, and as the Soviet itself threatened to do in Egypt when the British and French attempted to take control of the Suez Canal. Those legalists in the United Nations who prefer to deal in semantics rather than face the facts of life, and delegates of so-called neutralist members, would then take the position that, because the Soviet armies are labelled "volunteers," the Soviet is really not at war and

Proclamation

To All Subordinate Lodges and Members of the Grand Lodge of the Benevolent and Protective Order of Elks of the United States of America

GREETINGS:

The Grand Exalted Ruler, by and with the approval of the Board of Grand Trustees of the Benevolent and Protective Order of Elks of the United States of America, acting upon authority given him under Section 6, Article 3, Grand Lodge Constitution, does hereby proclaim that the next session of the membership and representatives of the Grand Lodge of the Benevolent and Protective Order of Elks will convene in San Francisco, California, July 14, 1957, with the opening and public meeting to be held in the Civic Auditorium in the Civic Center of San Francisco on Sunday, July 14, at eight o'clock in the evening.

The opening business session will convene in the Civic Auditorium at 9:00 Monday morning, July 15, 1957, at which time the election of officers for the ensuing year will be held. Business sessions will continue thereafter each morning at 9:00 on July 16, 17 and 18 until the business to come before the sessions is finished.

The Sheraton-Palace Hotel has been selected as Headquarters for the 93rd Session of the Grand Lodge. The South Lobby on the main floor of the Sheraton-Palace Hotel has been set aside for the REGISTRATION of all Grand Lodge Officers, Committeemen, District Deputies, Subordinate Lodge Representatives, Grand Lodge Members and their ladies. Visiting Elks and their ladies will register at San Francisco Lodge No. 3.

Room reservations for Past Grand Exalted Rulers, Grand Lodge Officers, Committeemen, and District Deputies will be made by Franklin J. Fitzpatrick, Convention Director, 161 East 42nd Street, New York 17, New York. He will mail reservation forms and a letter outlining the procedure.

Room reservations for Subordinate Lodge Representatives, Grand Lodge Members, all Elks and their families—with the exception of the Grand Lodge Party as outlined in the preceding paragraph—will be made through the State Associations. The National Convention Committee, following the practice of previous years, will allot rooms to each State Association and those planning to attend the Convention are urged to make the fact known to their State Association Housing Chairman immediately. Neither the National Convention Committee nor the San Francisco hotels will accept reservations direct from Lodges or individual Elks.

Dated: February 15, 1957.

Attest:

Grand Secretary
L. A. Donaldson

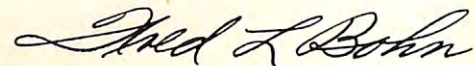

FRED L. BOHN
GRAND EXALTED RULER

that therefore no action could be taken against the Soviet Union itself. That is in effect what happened when a million Red Chinese troops fought against the United Nations in Korea.

Continuing with this dire prophecy, it could happen that little countries such as Switzerland and Finland might fall into the hands of the Soviet, no matter how unwilling their people may be, no matter what spirited resistance they may put up. And if the United Nations should in some way override the Soviet veto in the Security Council, and at long last decide to come to the aid of a victim of Soviet aggression—the Soviet homelands will be safe (as Red China was safe) because we will not "legally" be able to pursue our attackers back across their own borders, since Soviet bomber and fighter planes will be "volunteers" and not officially U.S.S.R. military components.

Well, what are we going to do about it? On November 4, 1956, the United Nations General Assembly adopted a resolution

"deploring the use of Soviet military forces to suppress the efforts of the Hungarian people to reassert their rights." It called upon the Government of the U.S.S.R. "to desist forthwith from all armed attack on the people of Hungary and . . . to withdraw all of its forces without delay from Hungarian territory." The resolution then went on to affirm the right of the Hungarian people to a government of their own without Soviet interference.

What happened? Nothing at all. When the General Assembly's resolution was presented to the Security Council for action, the Soviet Union, as one of the five permanent members with veto power, vetoed it.

Again, on December 12th, one month and eight days later, the General Assembly again condemned Soviet intervention in Hungary. By then Soviet troops had murdered thousands upon thousands of unarmed Hungarian citizens, and more than 150,000 Hungarian men, women and children had fled from their own country

into neighboring Austria. The vote in the General Assembly denouncing the Soviet Union was 55 to 8. Only the Soviet and its bloc of satellites were in opposition. Some of the "neutralist" nations, including India whose voting often coincides with that of the U.S.S.R. in the United Nations, abstained. What happened as a result of this 7 to 1 condemnation of the Soviet Union? Again, nothing at all.

The United Nations then adopted a resolution approving and instructing its Secretary General, Mr. Dag Hammarskjöld, to visit Budapest in order to acquire first-hand information on the situation there. The Soviet Union refused to permit the U. N. Secretary General to enter Hungary. The voice was that of the Hungarian Communist's Esau, but the hand was that of the Soviet Union's Jacob. When the Kremlin's puppet Janos Kadar said "No," it was understood that it was Moscow's Khrushchev who dictated the reply. And this in spite of the fact that Article 104 of the U. N. Charter gives the Secretary General the right to enter the territory of any member nation without waiting for approval from anyone. It says: "The Organization (the U. N.) shall enjoy in the territory of each of its Members such legal capacity as may be necessary for the exercise of its functions and the fulfillment of its purposes." Hungary is a member nation. But the Kremlin wants no outsider to visit Budapest until it has a chance to sweep the evidence of its murders there under the rug.

NEED NOT BE SUBSERVIENT

I can assure you that the civilized world need not continue to be subservient to the Soviet Union, and that we do not have to sit by idly while the Soviet Communists, their satellites, and their apologists in the United Nations tear our world to pieces and produce another world war. The United Nations Charter provides for adequate restraints against aggressors. They can be punished or suspended or expelled. It is high time that we took action in the United Nations against the most consistent and most deadly violator of the United Nations Charter, the Soviet Union. If we do not even make the attempt, we will have no right to complain if, in the international battle royal that the Communists call "co-existence," we literally as well as figuratively allow ourselves to be destroyed.

If only the Soviet Union is going to be free of all rules and regulations to which all the other members of the United Nations must adhere—if the bank robber is not to be amenable to the police force—if the law is to be applied only to the law abiding, or to the little defenseless nations, or to the large ones in which free press and free public opinion keep their own governments in line—if there are to be no sanctions against Communist aggressors—if only the Soviet Union is to use the veto power and there is to be a double standard of morality in the United Nations—if the U. N. is to say "yes" to all Soviet violations, and "no" to transgres-

SITTING PRETTY



With Melrose Rare you're really sitting pretty with "the very best" drinks! What makes it Rare? It's mellowed with superb whiskies seven years old... more, finer whiskies than any leading blend.

"My master prefers Melrose"

There's nothing to compare with

MELROSE RARE

BLENDING WHISKEY, 86, 86.8, 90 PROOF, 40% STRAIGHT WHISKIES 7 YEARS OLD, 60% GRAIN NEUTRAL SPIRITS, MELROSE DISTILLERS CO., N. Y.

Bass Fishermen will Say I'm Crazy... until they try my method!



But, after an honest trial, if you're at all like the other men to whom I've told my strange plan, you'll guard it with your last breath.

Don't jump at conclusions. I'm not a manufacturer of any fancy new lure. I have no reels or lines to sell. I'm a professional man and make a good living in my profession. But my all-absorbing hobby is fishing. And, quite by accident, I've discovered how to go to waters that most fishermen say are fished out and come in with a good catch of the biggest bass that you ever saw. The savage old bass that got so big, because they were "wise" to every ordinary way of fishing.

This METHOD is NOT spinning, trolling, casting, fly fishing, trot line fishing, set line fishing, hand line fishing, live bait fishing, jugging, netting, trapping, or seining. No live bait or prepared bait is used. You can carry all of the equipment you need in one hand.

The whole method can be learned in twenty minutes—twenty minutes of fascinating reading. All the extra equipment you need, you can buy locally at a cost of less than a dollar. Yet with it, you can come in after an hour or two of the greatest excitement of your life, with a stringer full. Not one or two miserable 12 or 14 inch over-sized keepers—but five or six real beauties with real poundage behind them. The kind that don't need a word of explanation of the professional skill of the man who caught them. Absolutely legal, too—in every state.

This amazing method was developed by a little group of professional fishermen. Though they were public guides, they rarely divulged their method to their patrons. They used it only when fishing for their own tables. It is possible that no man on your waters has ever seen it, ever heard of it, or ever used it. And when you have given it the first trial, you will be as closed-mouthed as a man who has suddenly discovered a gold mine. Because with this method you can fish within a hundred feet of the best fishermen in the county

and pull in ferocious big ones while they come home empty handed. No special skill is required. The method is just as deadly in the hands of a novice as in the hands of an old timer. My method will be disclosed only to those men in each area who will give me their word of honor not to give the method to anyone else.

Send me your name. Let me tell you how you can try out this deadly method of bringing in big bass from your local waters. Let me tell you why I let you try out my unusual method for the whole fishing season without risking a penny of your money. Send your name for details of my money-back trial offer. There is no charge for this information, now or at any other time. Just your name is all I need. But I guarantee that the information I send you will make you a completeskptic—until you decide to try my method! And then, your own catches will fill you with disbelief. Send your name, today. This will be fun.

ERIC A. FARE, Libertyville 12, Illinois

Eric A. Fare, Libertyville 12, Illinois

Dear Mr. Fare: Send me complete information without any charge and without the slightest obligation. Tell me how I can learn your method of catching big bass from waters many say are "fished out," even when the old timers are reporting "No Luck."

Name.....

Address.....

City..... Zone..... State.....

sions of all others—if the Soviet Union is to receive all the benefits of its association with civilized countries in the U. N. but accept none of the responsibilities—the United Nations loses the moral basis upon which it is supposed to rest.

The United Nations has a place if it stands on principle. This must not be com-

promised, and it would not be compromised if the delegates of the member nations would at long last give up their wishful dreaming of a voluntary change of character on the part of the Soviet Union, and come to grips with the fact that you cannot tame a cobra by kissing it on both cheeks.

A text I would recommend to the democratic members of the United Nations is that of 2nd Corinthians, Chapter 6, Verse 14. It says: "Be ye not unequally yoked together with unbelievers: for what fellowship hath righteousness with unrighteousness? and what communion has light with darkness?"



For our many readers who visit New York City the year 'round and who look forward to enjoying some of New York's famous sea food, we recommend the Sea Fare Restaurants. In mid-town at 1033 First Avenue (57th Street) and at 44 West 8th Street in the heart of Greenwich Village, you will find the freshest and finest of practically every variety of fare from lake, river, bay or ocean. Both restaurants, with an unusual decor and built-in waterfalls, are open every day of the week. Your choice, whether from the bar or the kitchen, will be tastefully prepared and served in a most restful and attractive atmosphere and at moderate prices. Take our word for it, a visit to Sea Fare will be one of the memorable events of your trip East.

★ ★ ★

The Saxony Hotel in Miami Beach this year adds another "first" in hotel achievement. It is the Saxony Style American Food plan. There is no restriction whatsoever on a menu choice that allows the guest to eat steak every night, if he wishes.

★ ★ ★

And in Miami we recommend to our readers the Alcazar Hotel, facing beautiful Biscayne Bay, the Convention Hall, Bayfront Park and the Yacht Basins. It is located in the heart of all activities—theaters, shopping center and churches. Its surroundings are quiet, its location incomparable and its facilities are excellent. We know you will enjoy your stay at the Alcazar.

★ ★ ★

Bermuda continues to be a favorite spot for many of our readers. Outdoor activity is now in full swing at this Mid-Atlantic Colony. Fishing, golf and tennis are being enjoyed by more visitors this year than ever before, and Eastern Air Lines, which serves the Islands, predicts the busiest winter season on record.

★ ★ ★

Phoenix, another popular spot for our readers, according to the U. S. Weather Bureau is the sunniest and driest resort in the nation. This city, capital of Arizona's Valley of the Sun vacationland, receives 86 per cent of the possible sunshine and

has an average relative humidity of 39 per cent—no other resort can boast of better conditions.

★ ★ ★

The 1957 Touring Edition of Hotels and Restaurants in the British Isles is now on the press and soon will be available from the British Travel Association in this country and in London. It contains full information (including rates) about more than 4,000 selected hotels in England, Scotland, Wales and Northern Ire-

For Elks Who Travel

(Continued from page 23)

and this becomes a taco. Have I lost anyone?

Of the excursions in the neighborhood I would certainly suggest a visit to University City, which is a magnificent expanse of brightly colored buildings fashioned in daring architecture and far more advanced, in design at least, than almost anything available above the border. The Basilica of Guadeloupe is only about fifteen minutes away from the center of things. It is the site of an annual pilgrimage by some 5,000,000 Mexican Catholics, whose piety is every bit as fervent as the pilgrims who wend their way yearly to Benares and

land, with tourist maps and a list of recommended restaurants in Britain. Price will be seven shillings—\$1.00.

★ ★ ★

As a result of the opening of the Tappan Zee Bridge on the Throughway at Tarrytown in 1955, the Yonkers Ferry has suspended operations between Yonkers and Alpine, New Jersey. After 34 years, the ferry will no longer be a favorite ride across the Hudson.

Mecca. When I was there in December the pilgrims had already begun to come in, walking from all corners of Mexico and some of them making the last few hundred yards up the plaza in front of the Basilica on their knees. In the van of each unit was a floral offering carried by several worshippers, often a huge and ornate piece. The pilgrimages have been going on for 424 years, or from the time the Virgin of Guadeloupe appeared before an Indian named Cuauhtlatotzin and performed a number of miracles.

Flying into Mexico City is now a 7½-hour trip from New York via Air France, which still holds the only non-stop routing from the northeast. It is 5½ hours from Los Angeles via Mexican de Aviacion, an

GRAND EXALTED RULER'S SPECIAL

For the consideration of members in Eastern, Southern, Mid-west and Northwestern States, The Elks Magazine has arranged with the Northern Pacific Railway for a Grand Exalted Ruler's Special Train to San Francisco, where the Grand Lodge Convention will be held July 14-18.

Grand Exalted Ruler Bohn plans to board the train in Chicago on July 8th at the time of departure between 9:00 pm and 10:45 pm. Experienced escorts will be on hand to handle tickets, baggage, reservations and other personal accommodations to leave full freedom for visiting and broadening Elk friendships as the train moves across the country through the scenic route of the Northern Pacific Railway. The train will arrive in Seattle on July 11th and will depart the evening of July 12th via Northern Pacific and Southern Pacific lines. Saturday, July 13th, will be spent enroute through Oregon and California, with views of Mount Shasta and Mount Lassen. Arrival is scheduled in Oakland that evening. A trip by ferry over Golden Gate to San Francisco will terminate this outstanding trip.

Complete details on the Grand Exalted Ruler's Special, as well as post-Convention trips to Alaska and Hawaii, which are sponsored by Northern Pacific, are available by writing to The Elks Magazine, Travel Department, 386 Fourth Avenue, New York 16, N.Y.

affiliate of Pan American, or four hours across the Gulf from Miami. And speaking of the flight to Mexico City, if you plan to be in San Francisco in July for the Grand Lodge Convention and are thinking about extending your vacation to Mexico, don't overlook the Elks Post Convention tour which leaves the Convention City on July 19th for an outstanding trip to our Neighbor to the South. Full details are available from the Travel Department, The Elks Magazine, 386 Fourth Avenue, New York, N. Y.

Mexico City has one of the most attractive airports either here or in Europe, all done in a suggestion of local architectural style, freshed with plants and altogether a fitting example for the airport planners to the north. The same airport will lead you in one hour or less to the sportland of Acapulco, comparatively an inexpensive resort and yet one chucked with sun, sand, sea, nightlife and unexpected excitement.

For instance, there is no place else in the world where the nightclub show features, as it does at La Perla in the Hotel El Mirador, the nightly spectacle of divers leaping off a cliff into a narrow gorge—all done by the light of bonfires and torches, not to mention a tremendous amount of nerve. Patrons may dance before and after on a cantilevered platform supported by teakwood beams from an old ship that once foundered off shore.

El Mirador has any number of cottage rooms tucked away in the sides of the mountains and its dining room, above La Perla, also is open to the sea. Across the street from El Mirador is a collection of women's shops which make local designs to order and to size in a day's time—shorts, slacks, sometimes appliqued with embroidery done in the hinterlands, and even sandals. Jaime's downtown has a selection of advanced men's fashions but you have to be prepared to accept novel design and use of color.

La Club de Pesca has a huge air-conditioned hotel and air-conditioned cottages as well. Each is complete unto itself and pleasantly secluded from the adjoining one. It has its own flotilla of fishing craft which take out from the dock at the foot of hotel's lawn in search of sail and marlin in some of the world's best fishing grounds. A new hotel has opened up the strip at Puerto Marques, all done up in Mayan design (the Mayans lived in Guatamal and Yucatan), and perched plunk on an uninhabited beach that is sand, sand, sand as far as the eye can see.

NEW ORLEANS MARDI GRAS

The famous Mardi Gras will open in New Orleans, La., on March 5th.

Benjamin Washastrom, P.E.R. and Secy. of New Orleans Lodge No. 30, 705 Common Street, requests that any members who desire to make reservations for that festival do so without delay.

Elegance by Schenley



See what you buy...

Schenley is clearly finer
in the bottle... clearly finer
to your taste.

*Elegance graces each product
that bears the name Schenley*

SCHENLEY DISTILLERS CO., N. Y. C. BLENDED WHISKEY, 86 PROOF, 65% GRAIN-NEUTRAL SPIRITS

ROD & GUN

BY TED TRUEBLOOD

In the remote North there is the ideal trout for fly fishing.



THE WATER was as clear as a baby's conscience. It was so clear that pebbles on the bottom looked close enough to pick up without getting

the cuffs of my sleeves wet, yet it took two-thirds the length of a nine-foot fly rod to reach them. On this water, a tiny fly was floating.

I had cast it to a seething mass of bubbles at the head of the pool. Here, caught in the V between two boulders, nearly half the river plunged in. The bubbles that it swept down made the clear water white for four yards as they rose through it and came sizzling to the surface.

The tiny dry fly floated toward me, away from the bubbles. I gathered line apace, fast enough to take up slack but not so fast as to pull the fly across the surface.

Suddenly, far down in the clear, sunlit water, possibly six feet beneath the fly, I saw a speck of color. A short instant later, the speck became a fish. It was swimming up and up through the transparent water toward my fly.

My grip tightened on the rod and I gathered the line carefully. To pull the fly now would be disastrous; to permit excessive slack in line or leader would be nearly as bad. The fish came on. It seemed that it would take forever for him to reach the fly.

At last, he broke the surface. He came out of the water in a deliberate roll, the way an Atlantic salmon sometimes does, or a big brown trout. The movement was so perfectly executed that it seemed slow, yet it actually was not slow. First his head, then his shoulders, then his back and the upper half of his tail arched up and then down, and when I could see him full length under the clear water again I raised the rod tip sharply to set the hook.

The bamboo came up solid and stopped. There was no quivering, no zig-zag, just solid weight. He was a good fish, probably two pounds. The rod held motionless for only an instant, though. Then the tip went down and the line sizzled out, very fast. Up toward the head of the pool it went and down to invisible depths, close to the bottom, in the full sweep of the current.

The fish hung there, swinging back and forth, feeling the strong current for half a minute. Then he turned and swept downstream past the boulder on which I

was standing. It was impossible to gather line as fast as he came toward me. It dragged behind him in a great loop.

At the very foot of the pool, in the slick where the water gathered speed to plunge down into the rapids below, the line came tight. I saw the fish start up from the depths and dropped the rod tip. He shot out. His jump resembled the sharp upward soaring of a bird more than it did the shaking leap of a bass. It was beautiful, clean, graceful movement; a flash of living color surrounded by sparkling spray.

He began, next, to swing back and forth across the foot of the pool, hanging hard in the heavy current. My fly was small and I knew his mouth was tender. I didn't dare to hold too strongly and yet

I knew that he would be gone forever if he gained another yard or two of line and went down into the white water. I had no choice but to keep the rod bent sharply and pray for the hook to hold until he decided to turn upstream.

Finally, he came. He passed me again, not so deep this time. I could see him, far down in the clear water, swimming deliberately upstream through the heaviest flow. He went into the white, foaming bubbles, beyond the spot where he had risen, and then cut sharply toward the far side of the pool. I was glad to see him go. This was a safe direction, and the sound of the reel giving line was welcome.

He jumped again and again in the slower, shallower water. I dropped the

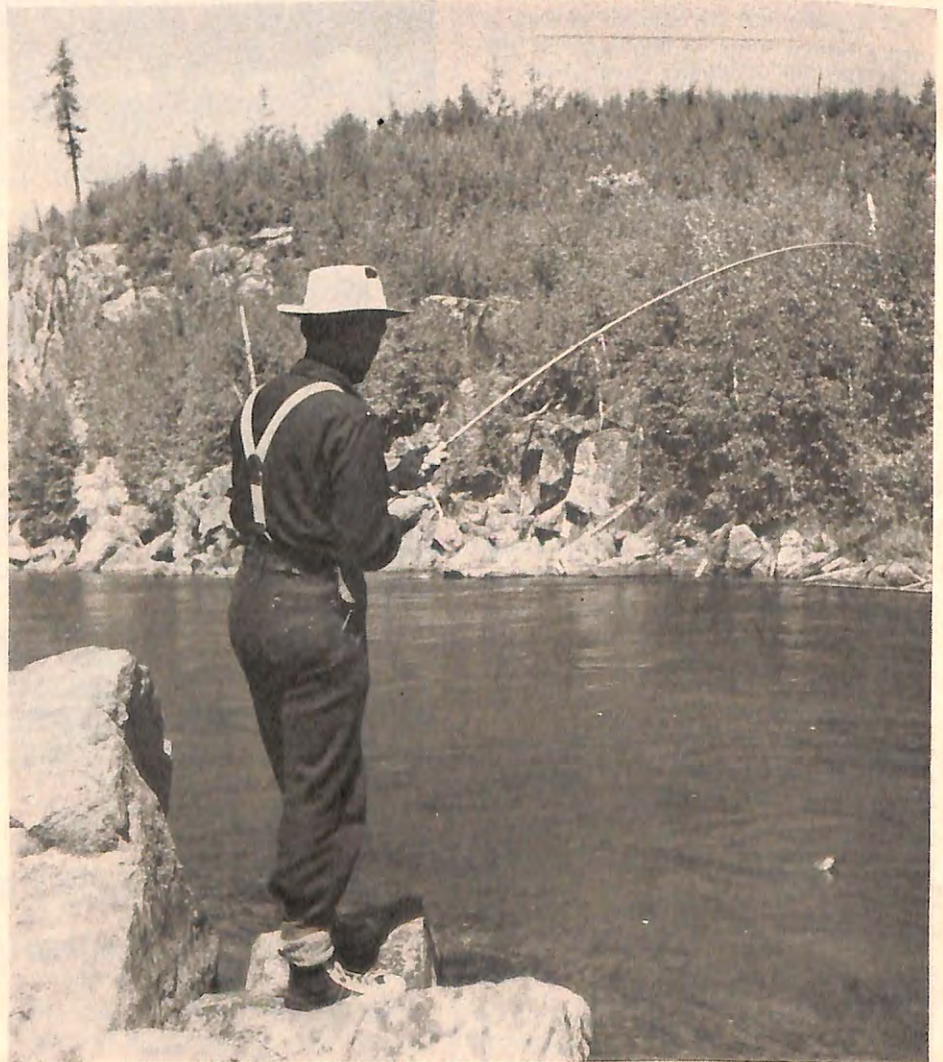

"These fish were critical enough to please anyone."

GRAND EXALTED RULER BOHN'S YOUTH DAY PROCLAMATION

Our young people are growing up in the most turbulent era in the nation's history. In the years ahead they will be facing grave responsibilities and making decisions affecting the destiny of America. Now, as never before, they need our wise counsel, sympathetic understanding and encouragement to prepare themselves for the duties of adult citizenship. Yet today America's youth has been summoned before the bar of public opinion to answer to a blanket charge of 'juvenile delinquency'. This grossly unfair indictment has been levelled by many unthinking people who have failed to distinguish between the vast majority of decent, self-respecting young people and the comparatively few youthful wrongdoers.

We have seen our youth in action, noting with pride their record of achievement in the schools, the churches, in the civic and social life of their communities. Rather than being made to bear the stigma of 'juvenile delinquency', a term applied all too widely and inadvisedly nowadays, they should be receiving deserved recognition for their steadfast adherence to 'juvenile decency'.

It is to give such constructive recognition that the Elks traditionally designate one day in the year, dedicated to honoring young America, underscoring their contributions to the life of community, state and nation. With this positive objective in view, I, Fred L. Bohn, Grand Exalted Ruler of the Benevolent and Protective Order of Elks, do proclaim May 1, 1957, as Elks National Youth Day. I ask every Lodge and every Elk to give this day meaning by holding community-wide observances which will show our young people that we are proud of them; that we stand ready to guide them in their every gainful endeavor; and that we are confident they will be ready one day to assume the responsibility for the welfare of our beloved country, and will indeed be worthy of this sacred trust.

FRED L. BOHN
Grand Exalted Ruler

tip quickly each time and then raised as quickly again to keep the line from sagging into the heavy flow between us.

At last, he began to tire. I reeled as he came toward me slowly. He was able to turn downstream again and make a feeble run when he felt the strong current of the middle pool, but he was struggling near the surface. It was easy to turn him now. I led him across below me and into an eddy on my side. Then I climbed down to the water level and when he came swinging past, dead tired, it was no trick to slip my hand beneath him and lift him up.

I leaned my rod against the boulder and picked the fly from his jaw. He was a grayling, a beautiful Arctic grayling, the sailfish of the North. He was, perhaps, the fiftieth I had caught that day, but I could not resist admiring him briefly before lowering him into the water and keeping him carefully upright until his strength returned and he was able to swim away.

Holding him was like holding a double handful of precious jewels and knowing that they would melt away through my fingers in an instant. When the grayling

came up through the clear water toward my fly, he had appeared blue-green. When he rolled above the surface to take it, he had looked pink. When he jumped, surrounded by a halo of droplets sparkling in the sunlight, my visual impression had been a mixture of pinkish bronze, emerald and silver.

Now, a prisoner in my hands, his colors were already fading. The pink-bronze of his upper sides and back was rapidly growing darker. His flanks were losing their pearlescent sheen and becoming a lifeless white. Only the bright lines on his spreading pectorals and the vivid, blue-green dots of his bronze-edged dorsal retained their brilliance. I watched it waving flag-like in the clear water as he swam away.

If I had killed him, his back would have turned almost black. His sides would have become dull white. Only his pectoral fins and his beautiful, sail-like dorsal, which was nearly half the length of his body and two-thirds its depth, would have kept their colors.

Each game fish has certain qualities that distinguish it. The largemouth bass has his violent strike; the rainbow his

EASY CASTS QUICK AS A FLASH



... with
**PUSH-BUTTON
Magic!**

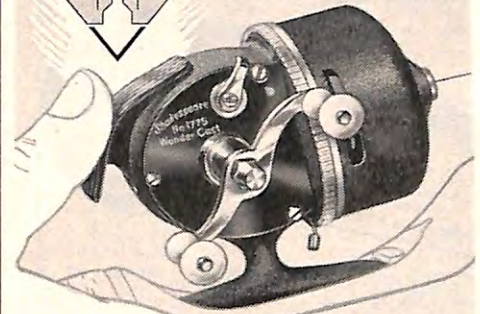

No. 1775
WONDERCAST
\$19.95

Shakespeare PUSH-BUTTON WONDERCAST

"Fishin' Fun"
FOR
Everyone!



Just a push of the button and a s-w-i-s-h of the rod—presto—you're push-button fishing. Combines the advantages of bait casting and spinning. Ask your dealer about its rugged construction, machined gears. Smooth adjustable "safety" drag... non-reverse crank and other outstanding features. Expert or beginner, you're ready for *more* fishing fun! No. 1775 (with 125 yds. 6-lb. monofilament). \$19.95

5 BRAND NEW FISHING BOOKLETS AND CALENDAR FREE

Latest in fishing tips and tricks by the experts. Covers spinning, bait casting, push-button, fly and salt water fishing. Send today!



SHAKESPEARE COMPANY
Dept. E-3, Kalamazoo, Michigan

Please send me your 5 brand new fishing booklets and calendar, free!

NAME _____

ADDRESS _____

CITY _____ ZONE _____ STATE _____

**BARGAIN INTRODUCTORY
1/2 PRICE OFFER**

Every Fisherman Needs
**WALTCO'S New, Improved
Stubcaster**

CASTING AND TROLLING ROD



Regular Price
\$6.95

ONLY \$3.47

WITHOUT REEL

Limited To First Five
Orders From Any County

Fishing's more fun when you team up a STUBCASTER rod with any of the new closed-face, American-type spin reels. The shortened arc of this 21" rod means far greater casting accuracy and the patented coil spring gives you sensitive, full length rod action in playing a fish. Breaks to 14" to fit tackle box—brings fish right to net—cast safely with 3 or 4 in a boat.

Convince yourself that STUBCASTER is the finest casting and trolling rod, at our risk! Once you've used it, you'll rave about it to your friends and create a demand for STUBCASTER that WALTCO dealers everywhere are ready to fill. For this favor from you, we'll rush you a \$6.95 STUBCASTER for only half price . . . send only \$3.47 postpaid (No C.O.D.'s). Offer limited to first 5 orders from any county in U.S.A. You'll have 30 days to use it on our money back Free Trial Offer. Order yours now!

WALTCO 4501 S. Western Avenue
Dept. C-2, Chicago 9, Ill.

OVER 30,000 IN USE!

THROW AWAY YOUR OARS!

★ Ideal for FISHERMEN, DUCKHUNTERS, SAILBOATERS . . . BOATS UP TO 20' LONG!

★ Precision Engineered & Guaranteed!

★ Boat glides swift, silent . . . Leaves one hand free for trolling!

Approved By SPORTSMEN'S RESEARCH

HYDRO-FIN

DEALER INQUIRIES INVITED 17517 Mack Ave. Detroit 24, Mich.

SEND FOR OUR FREE BOOKLET!

PIONEER BOATS



Pioneer's press-formed 14' 8" aluminum boat is the most beautiful of all runabouts! 7 steel and 6 aluminum models, 28 sizes! Send post card for FREE Catalog.

PIONEER MFG. COMPANY, 713 Perry St., Middlebury, Ind.

FIRST IN THE FLEET



Seamate 14

New ideas in design . . . comfort . . . styling. Seats arranged for extra comfort & convenience. Choice of Boat-A-Ramic color combinations. Many models in molded plywood and aluminum.

Free literature.

WAGEMAKER COMPANY

Dept. 25-57

Grand Rapids, Michigan

sizzling runs and frantic leaps. The brown trout is noted for his wariness; the King salmon for his bulldog strength.

When the grayling is discussed, however, the first thing mentioned, almost always, is his beauty. You can't help it because he is so beautiful, but it is too bad. It is allowed to overshadow other qualities that contribute more to setting him apart as a game fish. Beauty alone, without something to back it up, is little recommendation.

On the whole, the grayling is not a terrifically hard fighter. What he does when you hook him depends a great deal on where that is. The grayling in a lake east of Nome were almost sluggish. They never jumped and their runs were deliberate and short. The water was bitterly cold, however, and I think that was the reason. Trout do not fight well when the water temperature is in the forties.

Grayling I caught from streams in northern Saskatchewan, where the water was warmer, were much more active. Most of them jumped repeatedly. Their runs, while probably not so long as those rainbows of equal weight would make, were equally as fast.

Nor is the grayling blessed with selective feeding habits comparable to those which make the brown trout so outstanding. The grayling is primarily an insect feeder, but at times he will hit any bright, glittering object moving in the water. In fact, this usually is the case. I have caught many of them on spinners; big, colorful 1/0 steelhead flies and wobbling spoons more than two inches long, while I was fishing for lake trout and salmon. Generally a grayling will hit any small, dark fly, fished either wet or dry, because most northern insects are small and dark. This is not always the case, however, and then he is more interesting.

ONE day, on one of the clearwater streams that flow into the glacial Tanana River, in Alaska, my brother Burt and I discovered that grayling *can* be as difficult as any trout. This unnamed creek—actually, it was almost a young river—was similar to many meadow streams in the Rockies. It was about 30 feet wide and two to four feet deep, except where it dropped into an occasional hole in a bend, and the water was very clear.

We saw grayling constantly from the time we started fishing and, judging from their movements in the water, they were feeding. Since they seldom broke the surface, we tried a variety of wet flies first. None was any good. Next, we tried dry flies, large and small, light and dark. The fish showed no interest in them whatever.

Finally, Burt offered them a small, dark-gray nymph on which we had sometimes caught difficult trout in the States. It was just what they wanted. We had wonderful fishing as long as our nymphs held out, and that was long enough.

Some folks find fault with the grayling

APRIL FISHING ISSUE

Next month, The Elks Magazine will feature its eighth annual Spring Fishing Issue, with feature articles by both Dan Holland and Ted Trueblood.

because of his lack of wariness. They say you can tie a No. 16 fly to a ten-pound-test leader and catch grayling. That often—but not always—is the case. It is hardly a fair criticism, however, because the grayling lives only in remote, northern streams and lakes. They are but lightly fished and some of them are never fished at all. Under similar circumstances, most trout would be unsuspecting, too.

Last summer I enjoyed some fabulous grayling fishing on the outlet to Careen Lake, in northern Saskatchewan, with Norman Ferrier, a Scotchman of many accomplishments, including the ability to handle a fly rod with the hand of a master. These fish were critical enough to please anybody. Without the right tackle, including a leader at least reasonably light and small flies, strikes were few and far between. The tackle had to be used properly, too. Line drag, sloppy casts and other common angler faults meant no rises. The fishing was extremely interesting.

So, summing it all up, the grayling mostly doesn't fight so hard, he frequently isn't at all selective, and in many waters he isn't a bit suspicious. Yet everybody who has fished for him lists him high among the game fish. Why?

No doubt his beauty and the country in which he is found are both factors, but I think there are others more important. First, perhaps, is his willingness to take a fly.

He is a good fly fish—possibly the best. There are many times when it is very difficult to take salmon, steelhead or trout of any kind on a fly. They're inclined to be moody, particularly the first two. Most of the time if a grayling can see a fly he'll hit it.

Second is the manner in which he does. He may rise deliberately and roll. He may come up from the depths so fast that his momentum carries him into the air with the fly in his mouth. He may even jump into the air first, in a beautiful arc, and take the fly as he comes down.

However he rises, he always does it with an air of finality. He comes to the fly as though nothing in the world could prevent his getting it. There is no stopping short to think it over, once he starts to rise. I cannot imagine a fly fisherman anywhere who would not thrill to this wholeheartedness.

Third, and finally, he has that same indescribable nobility as the ruffed grouse. He is first class, all the way. If he were human there is no doubt at all that he would be "quality folks."

Good Pitchers Take Charge

(Continued from page 15)

preference to drawing a base on balls."

Let's have a look back down the trail and see why failure prematurely overtook certain pitchers who came up to the majors amid the blaring of trumpets and with "phenomenon" written all over them. Remember Rex Barney and Joe Black of the Dodgers; Montia Kennedy and Bill Vosselle of the Giants, to mention only four? This quartet makes ideal "laboratory specimens" because each had a different weakness—flaws which were almost imperceptible at first, but which time magnified until they became discouragingly visible to the naked eye.

OF ALL THE YOUNG PITCHERS who have been trotted out for public inspection in the last decade, Barney perhaps shone the brightest. He had a blazing fast ball, a good curve and, under the right conditions, fair control. It was the "right conditions" under which Rex had fair control that provided the key to his downfall. Let an infielder boot a double-play ball behind him or an umpire make what he considered a bad decision and he was ready for the showers.

It was argued that Barney was mishandled, despite the fact that he was tried in practically every category known to pitching. On that memorable night in 1948, when he pitched a no-hitter against the Giants, the shouting echoed far into the morning. Barney had made it! Had he? Or was it merely a one-night stand: a holiday from his normal temperament? Unfortunately, it was the latter.

Then along came Chuck Dressen, a pretty shrewd manager, to Brooklyn. Chuck was convinced he knew the answer to Barney. He worked with him personally and diligently during spring training and it wasn't until the Dodgers reached Asheville, N. C., en route home, that Barney was called upon to pitch in an exhibition game. Chuck's obvious plan was to make Rex feel he was "something special"—a viewpoint which umpires didn't share. How many men Barney walked in the first inning of that game, nobody remembers. Dressen gave up. That was the last seen of Rex until he bobbed up as a radio announcer in Vero Beach, Fla.

Black stumbled over the same roadblock that would have meant disaster for any bookkeeper, salesman or trapeze performer. Joe simply couldn't acquire the knack of doing the right thing at the right time, despite the fact that he had one of the best catchers in the business in Roy Campanella.

Black came upon the horizon like a sunburst in 1952, winning fifteen games before opponents got his "number." It takes about three times around the circuit for opposing batters to size up a new pitcher, analyze what he's throwing and know what to expect of him under certain conditions. After that it's up to the rookie to out-guess

CLOSE-OUT \$3.95

\$9.95 Famous Make SPINNING REEL Only



Just 800 Left! Hurry!
First Come, First Served

Completely Automatic
No catches or releases to be moved.

CAN BE USED WITH ANY ROD

- Baitcasting
- Fly • Spinning

Due to a fortunate purchase, we can liquidate just 800 \$9.95 Nationally Advertised Spinning Reels for just \$3.95. When these are gone there will be no more available at this price. Here are the high priced features you'll get:

- 1—Completely Automatic—no catches or releases to be moved before reeling in.
- 2—The reel that absolutely cannot backlash.
- 3—You can fish with Monofilament Nylon "invisible" type line.
- 4—This reel works with any rod—fly, baitcasting or spinning.
- 5—Corrosion-proofed, streamlined case. Hardened and ground shaft with two bronze bearings.
- 6—Preloaded spools available for quick changeover to other weight lines. An exclusive feature.
- 7—Smooth action clutch permits playing the "big ones" without regard for strength of line.

Don't delay if you want to save \$6.00. Return this ad with your name and address and your check or money order for \$3.95. We'll ship your Spinning Reel all postage charges prepaid on a guarantee of satisfaction or your money back. Limit ONE to a CUSTOMER.

ILLINOIS MERCHANDISE MART, Dept. 46
1227 Loyola, Chicago 26, Ill.

WHY WALL STREET JOURNAL READERS LIVE BETTER

By a Subscriber

I work in a large city. Over a period of time I noticed that men who read The Wall Street Journal are better dressed, drive better cars, have better homes, and eat in better restaurants.

I said to myself, "Which came first, the hen or the egg? Do they read The Journal because they have more money, or do they have more money because they read The Journal?"

I started asking discreet questions. I found that men who are well off have to have the information in The Journal. And average fellows like me can win advancement and increased incomes by reading The Journal.

This story is typical. The Journal is a wonderful aid to men making \$7,000 to \$20,000 a year. To assure speedy delivery to you anywhere in the U.S., The Journal is printed daily in five cities—New York, Washington, Chicago, Dallas and San Francisco.

The Wall Street Journal has the largest staff of writers on business and finance. It costs \$20 a year, but in order to acquaint you with The Journal, we make this offer: You can get a Trial Subscription for 3 months for \$6. Just send this ad with check for \$6. Or tell us to bill you. Address: The Wall Street Journal, 44 Broad St., New York 4, N. Y. EM-3

Reminder

Because your Elks Magazine is so concerned that all letters addressed to it from readers reach it promptly we again want to remind those who write that our new publication address is—

386 Fourth Avenue
New York 16, New York

Naturally letters sent to 50 East 42nd Street, the address which the Magazine occupied previously are delayed in reaching the new address given above. If you correspond with the Magazine it will help if you preserve this notice or make a record of the new address.

Make Big Money Selling Hamburgers

Small Drive-In Paid Beginner \$26,700 Profit Very First Year

Mail coupon for my Free Book that shows you how to get into the big-pay restaurant business quick. Beginners with absolutely no previous experience can make a big success of it once they know the "angles" of the food business. Even small hamburger or road-side stands can pay fabulous profit to men and women who follow my simple instructions. One man, with only his wife to help him, opened a small Drive-In with a graveled parking strip. Yet in a single year this little business paid him a profit of more than \$26,000. But don't go into this restaurant business blindly. Let me show you how to start—how to get use of equipment without cash—how to rent on shares without buying—how to sell—how much to charge—how to get crowds coming in—how to start making money the very hour you open your doors for business. Everything is explained down to the very last detail in a fascinating 20-lesson course—based on my own experience—that you can study at home. Send for my FREE BOOK titled, "Cafe and Diner Business." No obligation whatever and you can decide about what you want to do

later. Everything I send you now is FREE, so mail the coupon right away. This is a great business.

SCHOOL OF RESTAURANT ARTS, Dept. 323-D, Fremont, Ohio

MAIL FOR FREE BOOK

SCHOOL OF RESTAURANT ARTS
Dept. 323-D, Fremont, Ohio

Please send me a Free copy of "Cafe and Diner Business." This request does not place me under any obligation whatsoever.

Name

Address

City Zone State

"TOOK IN \$217 FIRST 10 DAYS"

Some make more, some less

We help you to start Your Own All-Year Business

Make Big Money! With our easily operated, highly efficient wall washer, Chas. Stelle took in \$217 gross in first ten days. E. L. Goss took in more than \$10,000 in one year. E. C. Taber wrote, "I made \$400 gross in two weeks." And no wonder—this machine washes walls 6 times faster and better than by hand. **Your Money-making Opportunity.** Enjoy independence—freedom from bosses, layoffs. Customers everywhere—homes, offices, schools, etc. Expenses low, profits high. No shop necessary; operate from home. Can start spare time until your full time is available.



Lose no time. Get all facts without obligation

FREE BOOK! MAIL COUPON TODAY!

- VON SCHRADER MFG. CO.
- 324 "W" Pl., Racine, Wisconsin
- Send at once (no obligation) your FREE booklet containing information about your WALL WASHING MACHINE and how I can start my own permanent, profitable business.
- Name _____
- Address _____
- City _____ Zone _____ State _____



SAVE \$7.20 on NORELCO MEN'S ELECTRIC SHAVERS...

Latest model, brand new and fully guaranteed. Complete with case, cord and cleaning brush. Regularly retails at \$24.95. Our price \$17.75 postage paid. All orders filled within 24 hours. Your money back if you are not fully satisfied. Send check or money order to:

JOHN BROOKS, Dept. 326, Box 212, St. Louis 3, Mo.

FREE - U.S. STAMPS



U. S. 1943 Bi-Colored Flag of Occupied Nations (as illustrated) Airmails, Commemoratives, Regular Issues, included in this collection of 25 selected, all different, genuine U. S. Stamps. PLUS VALUABLE U. S. \$5.00 STAMP. Everything for 10c to cover mailing expenses. Approvals included. (returnable) Act at once.

WILLET CO. P. O. Box 390 Dept. 24, Mount Kisco, N. Y.

OWN a BIG FALCON LAKE ... TEXAS HOMESITE



NO DOWN PAYMENT—Only \$7.50 per Month!

At Falcon Lake, Texas, 497 miles of shore line. Excellent hunting and fishing. Average temp. 73°. Fine schools, stores, churches, low taxes. City water, electricity, phones. Adjoins city limits of thriving town. Perfect for vacationing or year around living. Buy to use or for investment. Full price only \$149.50. TRAILERS ARE WELCOME! Write today for FREE map, photos, other details. No obligation. Address HUGH MATLOCK, Dept. 1106, Pipe Creek, Texas

30% MORE SEATING CAPACITY

American Seating's new folding chair has independent-fold seat, saving nine inches over normal back-to-back spacing.



Upholstered spring-arch seat. Body-contour styling. Wide choice of colors and upholstery.

Write Dept. 180-F.

AMERICAN SEATING

Grand Rapids 2, Michigan

Branch Offices and Distributors in Principal Cities

opponents—or else. Campanella could call 'em, but he couldn't throw 'em. Joe continued to pitch just as he had in his debut—and threw himself right out of Brooklyn.

Take a college freshman, put him in the President's chair for a trial period, and you're apt to get the same results the Giants experienced with Kennedy. When Montia was brought to the Giants' spring training camp in Miami, Fla., in 1946 to be "shown off" by the owner of the Richmond, Va., club, to whom he belonged, he looked so promising the Giants shelled out \$25,000 without asking any questions after watching him pitch only two and one-third innings of an exhibition game against the Braves.

Seemingly, this youngster whose previous experience consisted of only twenty-one innings with the minor league Richmond club, had everything. His fast ball was like a streak and jumpy; his curves broke sharply.

Then came the dawn. A single incident typifies the "case history" of Kennedy. The Giants then were managed by Ott, who asked Dutch Ruether, a scout and former top-flight pitcher in his day, to "straighten the kid out." Dutch walked over to where Montia was warming up and, stopping him in the middle of his windup, showed him by illustration what he was doing wrong.

His stride was too long. He was letting the ball go before completing his stride. In winding up he was looking at first base instead of his target—the plate. Dutch handed the ball back to Kennedy, who remarked coolly:

"Well, you *could* be right."

What Montia really said, as interpreted by the writer, who was standing by, was:

"Listen, Grandpa, I made the big time in less than one year. And now you're trying to show *me* how to pitch?"

Few youngsters in the history of baseball ever received a more heart-breaking trial period than Kennedy before the Giants reluctantly shipped him back to the minors.

VOISELLE, "Case No. 4," represents an old, yet always new predicament. Voted the Rookie of the Year in 1944, when he won twenty-one games, Bill found it difficult to cope with prosperity. Baseball became little more than an interference with "outside" interests. And down went the hefty young righthander from Ninety-Six, N. C.

How about a pitcher who has control—plus, a reasonably good fast ball and curve, a willingness to listen to sound advice and adept in making a study of batters' weaknesses? Is that the winning formula? Larry Jansen, who made his major league debut with the Giants in 1947 with an astonishing 21-5 (won and lost) record, doesn't think so.

In Jansen's opinion, a pitcher's control can be too good, especially if it happens to be on the wrong pitch. Larry's stock-in-trade was a slider. His record became progressively worse after his freshman year,

despite the fact that he really was dedicated to baseball and clean living.

"On some of my worst days, my control was at its best," he said. "Maybe it doesn't make sense, but when a pitcher reaches the point where he can hit the outside two inches of the plate consistently, the batter knows just where to expect the pitch. It's not easy to believe, but it was on days when my control wasn't so good that I pitched some of my best games. On those days I not only fooled myself as to where the ball was going, but the batter, also."

To confuse the issue further, let's roll back a few years and listen to Hubbell the day he pitched a one-hitter against Pittsburgh in 1943. That game figuratively marked the end of the trail for Carl. It was the last fling of a great career. At the conclusion of the game, he told the writer:

"I can't understand it. Physically, I felt lousy out there today, yet every pitch went exactly where I wanted it. My screwball was breaking precisely at the right instant and my control was perfect."

Hubbell's control was perfect, so he pitched a one-hitter. When Jansen's control was flawless he was belted harder than on days when he was wild. There must be an answer. Maybe it's because Jansen's name wasn't Hubbell.

When asked for his conception of a big league pitcher-in-the-making, Ruether, who is regarded as one of the top scouts in the game, didn't hesitate.

"Show me a young pitcher who doesn't let the breaks of the game get him down, who isn't afraid to split the plate with the balls-and-strikes count 2-2, and I'll show you a guy who'll probably go somewhere. Yes, I know what the present generation thinks of references to the 'good ol' days', but when I was in the game a pitcher's head was supposed to be his most potent weapon. When all you have out there on the mound is an arm and uniform, the show's over."

What does John (Sloppy) Thurston, West Coast supervisor of scouting for the Chicago White Sox, look for first in a pitching prospect?

"His fast ball," said John quickly. "He might make good even though he doesn't have a fast ball, but he'll never become really great unless he can throw hard. I don't care how good his curve is, because there comes a time when you've got to throw that ball 'down the pipe'—and it better have a hop on it."

The Dodgers recently were forced to give up on their shining light, Billy Loes. Why couldn't he make it? Campanella's reaction was sought.

"There's a pitcher who should have been winning twenty games a year right along," said Campy. "He had the best curve, the best fast ball and he knows baseball, but he's stubborn and has ideas of his own. Many times, when I was catching him, I couldn't even guess what he was thinking about."

Those who can go back far enough to remember that model master of the

mound, Christy Mathewson, can recall a lot of what it takes to be a durable big league pitcher. Instead of a superiority complex, Matty had what might be called "commercialized cockiness." There was a definite psychological motive behind his seeming air of contempt as he surveyed a batter.

The first thing to accomplish in his routine was to establish the fact that the batter was regarded as "nobody to be afraid of." After that it was a battle of wits—a battle in which Matty usually was one jump ahead of the man at the plate. Mathewson thrived on predicaments. A

situation with the bases loaded and none out was no more terrifying to him than pitching batting practice. Baseball was his life—not just an income.

For a final summation, let's drop in at the Jersey City home of Willie Schaffer. For years Willie was a trainer, then a scout in the Boston area for the Giants. He saw them come and go and, as the parade passed, reached a conclusion. As Willie sees it, the qualities most needed by a big league pitcher today are, in the order of their importance:

Brains, nerve, speed, curves, control—and a good shortstop.

Report on Russia

(Continued from page 21)

tive farms. The Russians take good care of their livestock, but milking is done by hand. The operation of their tractors and other mechanized equipment was inefficient. For example, these farms do not stock spare parts. When repairs are needed, replacement parts are made by hand in the local machine shop, and the machine stands idle for long periods.

While traveling from Moscow to Kiev, Mr. James observed that oxen and buffalo were widely used for transport and to perform farm work, supplementing the tractors and occasional jeep.

But he has high praise for Moscow's subways, which are clean and well-lighted and provide fast, efficient transportation.

Similarly, he was greatly impressed by the schools and institutions of higher learning. Their physical plants and facilities are excellent, and they appeared to be well-organized and efficiently administered. The group visited nursery and grade schools and Moscow University, in addition to several junior colleges, of which there are reported to be some 900 in the country. A feature of Soviet education is the salaries that are paid to the students, with bonuses for the superior ones. The entire educational system lays great stress on technical studies and languages. Students appear well-disciplined and well cared for. All recreation throughout the system is organized and supervised.

Public entertainment facilities are scarce. In Moscow, citizens have the opera and ballet, and two movie houses that were showing old western films. While the party was in the Soviet capital, a small German circus was appearing there.

A highlight of the party's tour was a visit to the Hermitage in Leningrad, former winter palace of the Czars, now a public art gallery with a magnificent collection of Old Masters. Russians patronize it heavily, Mr. James reporting that some 6,000 were there the day he visited it. He asked repeatedly to see some modern Russian art, but never succeeded, despite the assurance of his guides that "they would get to it".

As for television, private citizens apparently have little access to it, judging from the scarcity of aerials. The receivers that he saw were, for the most part, primitive

types with four- and eight-inch screens. Another reason that no doubt explains the lack of television receivers is that they are priced from \$1,300 to \$3,000, with no credit buying.

While in Moscow, Brother James attended a session of a People's Court to observe Soviet justice in action. The court consisted of a judge assisted by two "jurors" appointed by the state (communist party). Hearings were brief, and decisions were handed down according to the "code of law" drafted by the communists. The "code" is the governing authority, there being no reference to precedent. He characterized the Soviet legal system as a government of men, not law, and consequently susceptible to all the vagaries, uncertainties and injustices inherent in such a system.

Prices for the ordinary commodities of life were extremely high in relation to the dollar. As an example, a decorative bird, made of chenille, cost \$7.50. Unusually interesting was the public market in Moscow. Here, those farmers who manage to produce above their government-fixed norms are permitted to sell the surplus. It is one of the few instances of capitalistic enterprise allowed by the communists.

Brother James found Russian bread, butter, borsch and tea to his liking, but food was, on the whole, of poor quality, badly prepared and lacking in variety. An aviation enthusiast of long standing, he observed that Russian planes, which he used frequently, were fairly modern, although he saw but one jet plane. Most of the planes were two-engine types. On the other hand, Russian trains were antiquated, but efficiently operated on slow schedules.

"One of the strongest impressions that I carried away with me was that a feeling of uncertainty pervades the people, including the officials of the communist party, who are, of course, the rulers of Russia," Brother James said. "Obviously, the people live in fear of the party's discipline, which regulates the minute details of their lives and closely circumscribes their acts and activities. But that has been the routine for nearly 40 years, and so has become more or less matter of fact. I think that the down-grading of Stalin has left

NEW FROM BURROUGHS!

AND OH, SO

THRIFTY!



Heard the news? Burroughs has taken its hand-operated adding machine (you know, the one with the incredibly low price tag!) and brightened it up with new styling and a rich Amber Gray color.

Faster and easier to operate? You bet! No increase in price? Certainly not!

Free try out? Just phone our local branch or dealer. Burroughs Corporation, Detroit 32, Michigan.



Burroughs THRIFTLINE
ADDING MACHINE

\$10,000.00 AND UP YEARLY

Now earned by hundreds who sell heavy 3-ply stainless steel cookware, chinaware and cutlery. Opportunities for managers positions and higher earnings available. Age is no handicap. Write to:

SALES MANAGER

P. O. Box 3038

South Bend 19, Ind.

FOR BIG MEN ONLY!



SEND FOR
FREE
CATALOG

Sizes 10 to 16
Widths AAA to EEE

We specialize in LARGE SIZES ONLY—sizes 10 to 16; widths AAA to EEE. Dress, sport, casual and work shoes; golf shoes; insulated boots; socks; slippers; rubbers; overshoes; shoe trees. Also . . . sport shirts in your exact, extra-long sleeve length. Enjoy perfect fit in your hard-to-find size of amazingly low cost. Satisfaction guaranteed. Sold by mail only. Write for FREE Style Book TODAY!

KING-SIZE, INC.
166 Brockton, Mass.

HUNDREDS OF IDEAS

for
BRONZE PLAQUES

FREE illustrated brochure shows hundreds of original ideas for reasonably priced solid bronze plaques—nameplates, awards, testimonials, honor rolls, memorials, markers.

Write For **FREE BROCHURE A** For trophy, medal, cup ideas ask for Brochure B.

INTERNATIONAL BRONZE TABLET CO., INC.

Dept. 40—150 West 22 St., New York 11



The OFFICE VALET and Checker RACKS

Costumers, Ward-robe Racks, Locker Racks and Check Rooms.

An Answer to every Wraps Problem

Welded steel Valet Racks keep wraps dry, aired and "in press"...end unsanitary locker room conditions... save floor space—fit in anywhere... standard in all strictly modern offices, factories, hotels, clubs, schools, churches, institutions or wherever there is a wraps problem.



Write for Catalog FL-3

VOGEL-PETERSON CO.

1121 West 37th St. Chicago 9, Ill.

Concrete Problem? Magicrete Latex!

Patch or resurface any concrete or masonry. Magicrete gives cement phenomenal adhesion. Bonds to old or new, wet or dry concrete. Repair floors, walls, foundations, driveways. Tuckpointing and repairing stucco or plaster. Mortar or grout for tile, glassblock, brick. Apply thick or trowel to feather edge. Stop concrete dust, mix with water, sweep on. Mix is cement gray but can be colored. A must for home owners, keeps indefinitely. Pint covers approx. 10 sq. ft. 1/8" thick. Send \$2.00 per pt. (money back guarantee) to Magicrete Prod. Co., 2828 N. Holton, Milw. 12, Wis.

How to OWN a \$25,000 year DURACLEAN BUSINESS

If you are reliable, we will establish you in your own business, locally train you, furnish everything to operate a Duraclean business. World-famous process cleans, revives and mothproofs rugs, upholstery, auto interiors on location. Just 4 appointments a day gross \$25,000.00 a year. MULTI-PLY profits by employing others. You will be only local service receiving National Advertising, Parents' Seal, 25 other regular services, \$495 down required, pay balance monthly. Send today for Dealership Program. No obligation. Write: DURACLEAN CO. 7-543 Duraclean Bldg., Deerfield, Ill.

GO UNERRINGLY WITH HULL AUTO COMPASS

Only a Hull Auto Compass can give you, behind the wheel, the unerring sense of direction of a homing pigeon. Know the right way at every turn, anywhere. No more guesswork, mistakes! At your dealer's or write for literature. MOST COMPASS DRIVERS \$4.95 and USE HULL \$6.50



HULL MFG. CO. P.O. Box 246-EE-2, Warren, Ohio

LAW FREE BOOK THE LAW TRAINED MAN

Write today for a FREE copy of illustrated law book, "THE LAW-TRAINED MAN," which shows how to earn the professional Bachelor of Laws (LL.B.) degree through home study of the famous Blackstone Law Course; All necessary books and lessons provided. Moderate cost; convenient terms. Write for FREE law training book today.

Blackstone School of Law, 225 N. Michigan Ave. Founded 1890 Dept. 113, Chicago 1, Ill.

ELKS ROAD SIGNS



Welcome visiting Elks to your Lodge by erecting these signs on main highways into your city.

30" Emblem sign in five colors, vitreous porcelain enamel on steel.

10" x 24" por. enam. plate with 3 lines of lettering available in 2 colors.

\$29.75 F.O.B. Chicago

Allow 3 weeks for shipment (We do not supply post)

RUSSELL-HAMPTON CO.

303 W. MONROE ST.

CHICAGO 6, ILL.

the ordinary people in a vacuum—not knowing whom or what to believe—and a little slow to transfer their loyalties to their new rulers, who now tell them that their late, great idol was a common murderer after having extolled him over the years as the great and omnipotent savior of Mother Russia and all her children.

"Illustrating this feeling, I believe, was an interesting incident that occurred while we were touring Stalin's country of Georgia, near the Turkish border. In the course of a large banquet at which we were being entertained, an official proposed that the gathering sing the Georgian national an-

them, which our hosts did with great beauty. Then we sang 'Oklahoma!,' but not nearly so well.

"At this point, the official asked that everyone sing the Russian national anthem. Not one person opened his mouth save the seven guides attached to our party.

"With religion nearly stamped out, with no place to repose their faith and trust, the people have nothing left to believe in. This could be an important factor in the outcome of the great struggle for power that is being waged by the leaders at the top."

"To Our Absent Brothers"

(Continued from page 13)

Oswego State Teachers Council, delivered the address at the Memorial Services sponsored by the Elks of Fulton, N. Y., which won second-place accolades in Group II. Rev. Dr. Harold McGilvray, Pastor of the First Congregational Church, offered the invocation and benediction, and the ritual was handled capably by E.R. Andrew Michaud and his officers, with Est. Lect. Knight Robert Quade in charge of arrangements. This well-attended ceremony paid tribute to the five Fulton Elks whose deaths occurred during the past year, all but one of whom had held office in the lodge. Included in the brochure describing this Service were black-bordered photographs and biographical notes on several of these men.

Sentiment Praised

In his address, Mr. Lanigan, a P.E.R. of the lodge, emphasized the virtues of the sentiment behind this traditional Elk observance, a proud admission of respect and affection in today's world "of selfish materialism".

Winding up the three top programs for lodges of less than 750 members, were the Services held by Rocky Mount, N. C., Elkdom at which P.E.R. Norman Y. Chambliss, Sr., Secretary of the lodge and Chairman of the Memorial Committee, gave the roll call of deceased members. P.D.D. Louis N. Howard of New Bern delivered the ad-

dress at the ceremony opened by E.R. Henry B. Johnson, paying honor to the memory of the 12 members missing from the lodge roster since the 1955 services. This program, held before an impressive floral cross in the lodge room, included appropriate musical selections.

Other Lodges Honored

In selecting the entries in the Memorial Services competition, the Grand Lodge Committee found a great many deserving of Honorable Mention. An outstandingly successful combined program to receive this honor was that sponsored by the Elks of San Benito, Brownsville and Harlingen, Texas, Lodges.

Others so rewarded include, in Group I, Ashtabula, Ohio, Ballard (Seattle), Wash., Cincinnati, Ohio, Clarksburg, W. Va., Corvallis, Ore., El Paso, Tex., Findlay, Ohio, Hudson, N. Y., Jamestown, N. D., Milwaukee, Wis., Pasadena, Calif., Philadelphia, Pa., Pueblo, Colo., Quincy, Mass., South Bend, Ind., and Willimantic, Conn.

In Group II, they are Barnesville, Ohio, Camden, N. J., Carlsbad, N. M., Charlottesville, Va., Chester, Ill., Cut Bank, Mont., Euclid, Ohio, Fairhope, Ala., Gloucester, Mass., Martinsville, Va., Massillon, Ohio, Mount Vernon, Ohio, Platteville, Wis., Reynoldsville, Pa., Salisbury, N. C., Valdosta, Ga., and Webster, Mass.



Elks National Home Lodge officers at their impressive Memorial Service when P.D.D. Paul S. Johnson of Roanoke, Va. (inset), spoke, left to right: Est. Loyal Knight P. H. Maley, Secy. A. J. Callear, Lect. Knight U. J. Overstreet, Treas. J. B. McQuade, E.R. R. C. Harlow, Chaplain Harry Connell, Esq. H. J. Cobb, Lead. Knight E. F. Gelhaus.

Warrior's Return

(Continued from page 11)

affect our date for tonight . . . It only means I'll have a chance to pick up the tickets earlier . . . Of course, in time for dinner. . . . Say, six o'clock? . . . And suppose we meet in the lobby of the Hotel Paradise. . . . You know where it is? And we'll drive back in your car. . . . Thank you, Thelma. . . . You're an angel, too."

WILLY SHAPIRO drove the old sedan across the George Washington Bridge from New Jersey, having accomplished in an hour and a half a journey that normally took forty minutes.

"This is the kind of a car you have to break in easy the first three hundred thousand miles," Willy said.

The great gray breadth of the Hudson was shrouded in mist as they crossed the bridge. Behind them were the barren cliffs of the Palisades. A tugboat, barely visible, was pressing a heavy barge against the tide. It blared a melancholy bass note out of the haze that attempted to envelop it. The steam came up like memories.

"It's like when we used to be on the road with Doc, fightin' bums all over, ain't it?" Willy said.

"I can't argue about that," Slattery agreed.

It was even the same sedan. Knowing Doc, and his stylish, free-spending ways, there seemed some inconsistency between his having had \$10,254 of which to be robbed, and his retention of this wheezing, oil-eating relic of those barnstorming days that Slattery had far from forgotten. It was five years since Doc had agreed with him that a reasonably creative brain would not be improved by repeated clompings on the head that contained it. Doc, for all his minor, jovial larcenies, had never exploited or abused a fighter in his life.

"Ol' Doc," said Slattery in reflective gratitude, "never tried to fatten his pockets on me. I'll say that much."

"Dolly said you'd prob'ly give us the brush-off," Willy said.

"Dolly?" Then he repeated the alarming word. "Dolly?"

"She works as Doc's secretary now. She says you're prob'ly too big for Henry Ford's britches, or Walter Reuther's, ever since you got a factory of your own for makin' them dolls."

"Stop the car," said Slattery. "Let me out." But the old car kept rolling. They had left the bridge and were trudging along the West Side Drive, parallel to the river.

"Dolly can be a real sweet kid," Willy said. "At times, I mean."

"Not with me she can't. Why did Doc bring her along?"

"I told you she works with us. She just got out of St. Joseph's last June."

"What's that—a jail?"

"A girl's college, Slats, in Michigan.

How come you an' Dolly never got along so good?"

"I don't know."

He had once felt that Dolly Brady, the orphaned and emotionally carnivorous niece of her loving uncle, should have been adopted by wolves or lend-leased to the Russians, for spite. Slattery, looking back, could recall that at age sixteen her only live heroes were her uncle and Jack Dempsey. The dead men her affections plucked from history were Nelson (Battling, that is; not Horatio, the Admiral) and two gentlemen named Kelly and Smith who are alleged to have fought for six hours and fifteen minutes near Melbourne, Australia, in October of 1856. Slattery's retirement from the ring had seemed to Dolly a flight from arms transcending the worst behavior of the Vichy French.

"Besides," said Slattery, "there was always somethin' about that skinny little weisenheimer of a broad that used to upset me."

"Dolly is no broad," Willy said.

"Well, excuse me."

It wasn't an expression one would use at the Hasty Oak Country Club, or, for that matter, at the Metropolitan Opera. In certain company, he supposed, a man was apt to revert.

SLATS, M'BOY," Ambrose "The Hon-est Doctor" Brady kept repeating. "Slatsy, Slatsy, you're a sight for damaged eyes."

Doc had always been a great one for original remarks. His right eye was framed in the thrilling shades of a ripened fleur-de-lis. His left brow had been hem-stitched. Seated in a wide chair, wearing a brocaded smoking jacket, Doc, in his middle years, didn't look like a fit opponent for Henny Sherman or Angel O'Hare, those human mastiffs in Arthur Krugman's employ.

"How did it happen?" Doc said. "You wouldn't believe me. I walked into Arthur's place for a couple of peaceful beers. Are you listenin' to me, Slats?"

He had been listening. It wasn't his fault this woman had walked in from another room. He felt a series of unwelcome sensations that he could always recall but never describe. She walked with her hands folded carefully before her, gracefully, easily, yet like an empress reviewing her troops. *Sixteen years plus five more years were twenty-one years*, he was thinking.

"Hello, Slats," Dolly said. "Welcome to Meatball Manor." She sat on the arm of her uncle's chair and began to stroke his currently lumpy head. "You were talking, dear?"

"I was tellin' Slats how I went into Arthur's place for a couple of beers and some of the boys were there. We were tellin' a few harmless lies, like how I just refused a hundred grand offer for The Viking, even though the kid just busts a hand, when Arthur suggests—that is, to me, Harry Ginsburg, Wicky Johnson and



monroe
FOLDING
BANQUET
TABLES

Direct Prices & Discounts to Clubs, Churches, Lodges, Schools and All Organizations

COMPLETE CATALOG ON REQUEST

MONROE TRUCKS

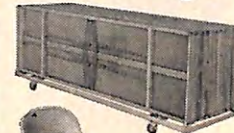

For handling and storing folding tables and chairs. The easy, modern way. Choice of models.



PORTABLE PARTITIONS

FOLDING CHAIRS

Steel built, sturdy, convenient.

Change your idle space into useful areas with these Partitions. Masonite panels in tubular steel frames with swivel action pedestals and casters or glides.

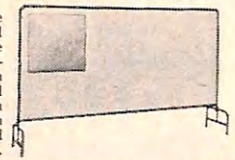

THE Monroe COMPANY
90 Church St. Colfax, Iowa



Everlasting Bronze BOOK OF MEMORY

For listing 100 to 3000 names economically. Write for free catalog including photos of hand-chased cast bronze plaques.

NEWMAN BROTHERS, Inc.
Dept. 722, Cincinnati 3, Ohio



A POSTCARD CAN PUT YOU IN A FINE BUSINESS!

Rush Card TODAY for FREE OUTFIT! Get in highly profitable, repeat-order shoe business! Sell amazing line of Air-Cushion Innersole comfort shoes to friends, neighbors, fellow workers. Dress, sport, work, safety shoes for men, women. Never sold in stores. Just 2 orders a day—in spare time—brings in \$168 EXTRA income a month! No investment. Send card TODAY for FREE SELLING OUTFIT! **MASON SHOE MFG. CO., Dept. 536, Chippewa Falls, Wisconsin.**



Make \$5 an Hour CASH PROFIT



THE DAY YOU START!

Start your own business at Home . . . Sharpen Household, Garden and Shop Tools in Spare Time.

Turn spare time into Big Cash Profits with new Belsaw Sharp-All. No experience needed to sharpen knives, scissors, shears, ice skates, mower blades, hedge trimmers, axes, chisels and circular saws . . . Learn how easily you can start your own spare time business. Amazing low cost easy-payment plan. Send Postcard for **FREE BOOK.**

BELSAW SHARP-ALL CO. 7267 Field Bldg., Kansas City 11, Mo.



Your own BUSINESS

win financial security and independence

with Dari-Delite

Get into fast-growing Dari-Delite drive-in ice cream business. You own and operate, yet are part of national organization providing help and advertising. No experience necessary. Total operating equipment, \$5,500; \$2,500 down, balance 3 years. Write for booklet. Dari-Delite, 1507 2d Av., Rock Island 7, Ill.



*"Me
Complain?
Never!"*

*"I make sure I'll be
satisfied—I always buy
a BRAND that's made
a NAME for itself!"*

FOUR WAYS BRANDS SATISFY

1. **BUY WITH TRUST!** Spend *confidently* on known quality. Brand Names wear best, work best, taste best, are best.
2. **SHOP WITH EASE!** Spend *efficiently* on proved value. Brand Names save time "puzzling" over labels, models, prices, etc.
3. **ENJOY MORE CHOICE!** Spend *shrewdly* among widest selections. Brand Names offer the most in sizes, types, colors, flavors, etc.
4. **GET THE "LATEST"!** Spend *smartly* on up-to-date products. Brand Names keep improving, modernizing, introducing new things.

BRAND NAMES FOUNDATION, INC.
437 FIFTH AVENUE, NEW YORK 16, N. Y.

RUPTURE-EASER
(A Piper Brace Truss) ®

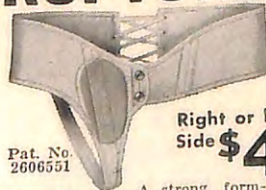

Double... \$5.95

Right or left
Side \$4.95

No
Fitting
Required

A strong, form-fitting washable support for reducible inguinal hernia. Back lacing adjustable. Snaps up in front. Adjustable leg strap. Soft, flat groin pad. No steel or leather bands. Unexcelled for comfort. Also used as after operation support. For men, women, children. Mail orders give measure around the lowest part of the abdomen and state right, left side or double. We Prepay Postage except C.O.D.'s.

PIPER BRACE CO.
Dept. EK-37 Kansas City 5, Mo.

811 Wyandotte

two other guys—that we play a little cards in the upstairs room."

"Then what?" said Slattery.

"Well, about nineteen hours later—that makes it just about four o'clock yesterday—I've got ten thousand, two hundred and fifty four dollars profit, most of it Arthur's."

"The game was honest?"

"With Harry Ginsburg in the game it's got to be honest," Doc said soberly. "Harry breaks about even and has to get a plane for Chicago. Wicky is out a few hundred dollars, the others about the same. They go home. I remember I count the money three times and decide I would like to make this a hobby. Arthur is a graceful loser, like a rat caught in a slide-trombone. He says to me, 'How much money did you bring into the game, you crumb?' and I ask him, 'What the hell is that your business?' But I can't help saying to Arthur, 'I had twelve dollars and fifteen cents,' which is the truth."

"I see," said Slattery. He tried not to look at the rounded, and, here and there, somewhat compounded "skinny little weisenheimer of a broad" he had earlier described. He kept his attention on Doc. "What happened then?"

"Well, Arthur picks up the phone and says, 'I want Henny an' Angel.' I figure he's not callin' them upstairs to give me a free shave, a shine or a shampoo. I give Arthur a little shove and I am downstairs with the money in a large linen napkin before Henny and Angel even start upstairs. The trouble is that by this time I'm too tired to run and I don't know where to cache the dough. That's when I remember Bobo McBride tends bar in Arthur's joint. Bobo's so honest he brings his own peanuts an' pretzels to work with him. I tell him what happened and he says he will pray for Arthur. Meantime he sticks my dough away down deep under the lemons and limes. He says he will transfer it later to the hollow baseball bat he uses for crushin' ice. I figure this is better than carryin' the cash with me in my condition."

"What about Henny and Angel?"

"Henny and Angel trail me to the washroom of a cafeteria on 47th Street," Doc said. "I am patting my face with wet paper towels when they come in. Angel bolts the outside door while Henny belts me one. They frisk me of exactly twelve dollars an' fifteen cents an' that's when I make the mistake of thinkin' it is funny. This time they really go to work on me. That's the whole story, Slats—except for Bobo McBride."

"Bobo didn't rob you. That much I know."

"Don't interrupt, please. Bobo calls up after midnight, while I'm changin' ice bags. He says he's got the money on his conscience. 'Just give it to me,' I tell him, 'an' you will have it off your conscience.' He says he has had a long talk with his wife and the pastor of their church. They say he should give me the money, but only if I didn't steal it. All

fight managers are crooks, he says, except for Harry Ginsburg. 'Get Harry to tell me you won it fair an' square and I will give it back to you,' says Bobo on the phone. I then say to him, 'Listen to me, you punchdrunk, chuckle-headed slob, Harry Ginsburg's in Chicago.' 'Oh,' he says, 'I forgot that, Doc. I wouldn't want to put you to a long inconvenience an' I wouldn't want to offend the wife. I'll tell you what you do,' he says. 'You go get George Slattery in New Jersey. Slats knows you better than I do. If he says he don't think it was a heist, I'll give the money to him. Just tell him to stop at the bar.' That's what Bobo told me, Slats. All you have to do is go and pick it up."

"It's cute," said Slattery, joylessly.

"What's cute?" Dolly said.

"Your uncle's private life."

"Is yours superior?"

They were standing now. She was quite tall. She had the same *I'm-ready-to-fight-you-and/or-the Marines* look in her eyes that she had always displayed when her emotions were involved. The difference was that she had since grown up to fit this eaglet complex and no longer looked ridiculous. It wasn't assumed. The plain, uncomplicated warmth of Dolly's affection for Doc, or her gentle friendship for Willy Shapiro, would heat an apartment house. *It's only with me she's always acted like a half-plucked porcupine*, he thought.

"I didn't mean anything about being—superior," he said, accenting the word, "but I do have some responsibilities I didn't have five years ago. Forty-six employees, for one thing, and some business contracts and expansion plans coming up. A brawl in Arthur Krugman's saloon would fix me up fine."

"You mean it's asking too much?" Dolly said. She looked painfully away. "Too much on the odd chance it might be undignified?"

"I didn't say I wouldn't do it."

A GOOD DOUBLE PLAY

Shortly after our December, 1955, cover, which showed a harried mailman burdened with letters and packages leaving his post office just as a housewife and her two children arrived carrying even more letters and packages, reached our readers, we received a letter from the "Postmasters Gazette." Editor Arthur V. Smith felt that the cover was equally fitting for his publication and requested use of the engravings for the following year.

Recently the December, 1956, issue of the "Gazette" arrived at the office and The Elks Magazine was gratified not only that the picture could be used again so effectively, but also with the credit that Editor Smith extended. "The Elks Magazine agreed with the editor of the 'Postmasters Gazette' that the cover was just as appropriate for postmasters as for the members of the great American organization—the BPOE", wrote Mr. Smith.

"Oh," she said. "Well, please don't think you have any unpaid debts around here. Don't attempt to be sorry for us."

"Ah, shut up," her uncle said, "the two of you."

Dolly left the room.

"You embarrass her," Doc said.

Slattery staggered. "Me?"

"Who else? She used to think you were the greatest man alive, and maybe it hasn't worn off yet. That's loyalty, boy."

"From the first day I met her to the last time I saw her," Slattery said, "she's hated me."

"A mere defense," Doc stated sagely. "You wouldn't kill the dragons she picked out for you, that's all. You didn't want to be the greatest fighter in the world. And you teased her. You used to call her 'Blimpy' when she was skinny as a stick."

"I wouldn't do it now," said Slattery soberly. "Not now."

"Maybe you were afraid of fallin' in love with her even then?" Doc suggested. "You know—some kind of inhibition? Like it wasn't respectable or decent to fall for a sixteen-year-old kid?"

"I'll hire my own psychiatrist," said Slattery, "and he won't be a lynin', tea leaf reader like you."

BOBO McBRIDE, the bartender, was a gentleman distinguished by one modestly caulflowered ear, a freshly laundered jacket and the clear, uncompromising gaze of a martyr disdaining a bandage for his eyes. Sincere was the word for Bobo.

"I could have met you some place else, but that seemed sneaky," Bobo said. "A matter of principle. You know how I don't like to tell a lie? Well, Arthur says to me yesterday, 'Did you see Brady, that crumb?' I said, 'Yes, I saw him go out.' 'Did he have a wad of dough with him?' says Arthur. 'Sure,' I said, 'he hands it right to me and I put it down here with the limes and lemons.' So Arthur says, 'How would you like a bat in the puss?' and walks away disgusted. It only goes to show you, Slats, how certain elements in our civilization are not prepared for a moral approach to every day livin'."

"I see what you mean."

"When you go out now," Bobo instructed him, "you just pick up this shoe box from the bar, as though you'd brought it in with you. You really figure that Doc won all this money on the level?"

"That much I'll guarantee," Slattery said. "But only that much. What are you doing now?"

"I'm takin' off the jacket an' the apron," Bobo said. "There must be other jobs in town."

SLATTERY walked east on 47th Street. He felt it wasn't too much to have done for Doc. He was willing to bet that if he explained the whole thing to Thelma and Mr. Travers they would find it amusing. If it was an excessive kind of free enterprise that Doc had practised for fifty years, a banker like Mr. Travers ought

certainly to appreciate Doc's initiative in multiplying \$12.15 to the sum contained in the shoe box. Slattery was thinking of this as he approached a parking lot where cars were wedged into the narrow space between two office buildings. He had just looked at his watch and observed it was 4:45, as good a time as any to pick up the opera tickets. He paused here briefly because a car was about to be backed into the only available space. The November day was closing fast. The street lights had come on. The wind whipped rubbish in the street.

"All right, Slatsy, you go first," someone directed him. Slattery held firmly to the cardboard box. He looked to his left, into the cordial, if somewhat dented, features of Angel O'Hare. He turned to his right and observed Henny Sherman, close and snug and business like. "This thing I got stuck in your back is not one of them space-pistols, Slats. Walk over there, behind the truck."

Slattery walked. He had certain impractical impulses, but suppressed them. He turned now, facing Arthur Krugman's sturdy boys. The gun in Henny's hand had not been made in Hasty Oak, N. J.

"How badly do you want to hold on to that box?" Henny said.

"I'm not too sure. But why would you want the box?"

"You haven't been in Arthur's place in years. You're a pal of Doc's. We knew somethin' was fishy."

They were very large men, Grade-B heavyweights, a decade past their primes. Angel O'Hare had hands the size of baseball gloves. He looked prepared to use them. Slattery found it depressing. He counted his responsibilities and chose again to be practical.

"Well," said Henny Sherman, "how bad do you want the box?"

"I don't want it that badly," Slattery confessed.

He watched them walk off in the gathering darkness. He walked slowly to the street. The parking attendant smiled at him, while patting a pocket with clear satisfaction.

"You want to call a cop or something, Mac?"

Slattery kept walking. Having already done the practical thing, he didn't feel entitled now to punch a smaller man.

ICAN UNDERSTAND YOUR POINT OF VIEW," Doc said. "It was only money, wasn't it? And you did what you could do?"

"I'm glad you feel that way," said Slattery.

They were assembled in one room, listening to his lugubrious account. Dolly Brady had said nothing. She was looking down at the folded hands in her lap. Willy Shapiro gave a new light to an old cigar, but you wouldn't call his silence accusing. The young man they called 'The Viking' stood to one side, like a blonde draught horse detached from his wagon, rubbing his nose with a bandaged hand.

Become an **ACCOUNTANT-**

Auditor—C. P. A.

The demand for skilled accountants—men who really know their business—is increasing. National and state legislation is requiring of business much more in the way of Auditing, Cost Accounting, Business Law, and Income Tax Procedure. Men who prove their qualifications in this important field are promoted to responsible executive positions.

SEND FOR FREE BOOK

Knowledge of bookkeeping unnecessary. We train you from ground up, or according to your individual needs. Low cost; easy terms.

Send name and address on the lines below for free illustrated book describing the LaSalle Accounting training and the opportunities in this highly profitable field.

LASALLE EXTENSION UNIVERSITY
A Correspondence Institution
417 S. Dearborn St., Dept. 3328H, Chicago 5, Ill.

Name.....

Address.....

City..... Zone..... State.....

LEARN WHILE YOU SLEEP

FREE! The amazing story of how YOU can enjoy a more abundant life... increase your self-confidence, health, vitality... improve your finances, will-power and develop a new, magnetic personality thru NOCTURNAL EDUCATION (Sleep-learning) as used by our Government, Universities and many of the World's most successful individuals. Send for revealing data... FREE!

CAMBRIDGE INSTITUTE
Dept. B 1157 S. Robertson Blvd., Los Angeles 35, Cal.

HOTEL PICCADILLY

TV and Air-Conditioning Available
GARAGE

Banquet Facilities 50 to 400

James P. Somerville, Resident Mgr.
Fred. J. McBride, Managing Director

227 West 45th Street, New York 36 • Circle 6-6600

WE PAY \$100

Each for certain Lincoln head pennies. Sort all U. S. coins for us during spare or full time. All coins are now in circulation and can be found by anyone. Send \$1.00 for catalog listing our buying prices. \$1.00 refunded on our first purchase we make from you.

VIROQUA COIN COMPANY
Dept. Y-24 Viroqua, Wisconsin

BOOK MANUSCRIPTS CONSIDERED

by cooperative publisher who offers authors early publication, higher royalty, national distribution, and beautifully designed books. All subjects welcomed. Write, or send your manuscript directly.

GREENWICH BOOK PUBLISHERS
Attn. Mr. Essex 489 Fifth Avenue
New York 17, N. Y.

Elks! FOR ALL MEMORABLE OCCASIONS BRONZE PLAQUES

Say it better... Say it forever... Say it for less
U. S. Bronze leadership in quality and artistry is forever impressing everybody everywhere, and low prices keep our customers pleased, too. Write now for new complete FREE color catalog and information—helpful suggestions for honor rolls, awards, memorials, testimonials, for everything. Write to

"Bronze Tablet Headquarters"
UNITED STATES BRONZE SIGN CO., Inc.
570 Broadway, Dept. E, N. Y. 12, N. Y.

New Midget Hearing Aid Has No Cord or "Button"

SO TINY IT IS WORN ON ONE EAR!

An amazing new transistor hearing aid that has no cord or receiver button has just been developed by Tonemaster Manufacturing Company of Peoria, Illinois. You can now have natural-like hearing with only a very tiny, inconspicuous unit behind one ear. Feather-light with full-range finger-tip volume adjustment, the revolutionary new Tonemaster can be slipped on or off the ear easier than a pair of glasses.

As all sound is received at ear level no static or clothing noise interferes with clear, natural hearing. Even in a swimming suit no wires or cords interfere or can be seen. Use the telephone in the normal position. Economical to operate, the new Tonemaster permits far more freedom with much clearer hearing. If you would like free descriptive literature for yourself or a friend, write today to Tonemaster Manufacturing Company, Dept. 1413, 128 So. Monroe, Peoria, Illinois. —Adv.

LOOK for Rupture Help



Try a Brooks Patented Air Cushion appliance. This marvelous invention for most forms of reducible rupture is GUARANTEED to bring YOU heavenly comfort and security—day and night—at work and at play—or it costs you NOTHING! Thousands happy. Light, neat-fitting. No hard pads or springs. For men, women, and children. Durable, cheap. Sent on trial to prove it. Not sold in stores. Beware of imitations. Write for Free Book on Rupture, no-risk trial order plan, and Proof of Results. Ready for you NOW!

BROOKS APPLIANCE CO., 329-H State St., Marshall, Mich.

NEW! ... SOFTER!

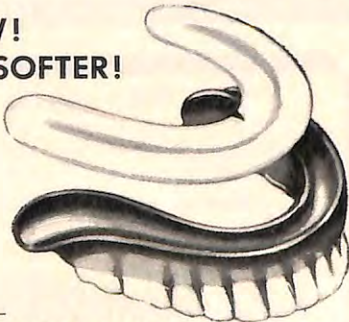

no matter —

HOW LOOSE YOUR PLATE IS —
HOW SORE YOUR GUMS —

EZO Dental Cushions
are guaranteed:

TO FIT PERFECTLY
FEEL TWICE AS SOFT
WEAR TWICE AS LONG

A new, softer, longer-lasting cushion guaranteed to REFIT your plates no matter how loose or how old. Relieves soreness caused by loose dentures. Eat everything! Easy to use — just place Ezo pad in plate. Results guaranteed or money back. Send \$1.25 for 16 uppers, \$1.25 for 20 lowers — or send \$2.50 for both.

EZO PRODUCTS COMPANY, Dept. 654-B
Box 9306, Philadelphia 39, Penna.

"It occurred to me after you left here," Doc said, "that maybe Arthur would catch on. I said to Willy, 'Henny or Angel might have a gun, but they'd never use it, really.' I guess you didn't know that, though—huh, Slats? And then I said to Willy, 'If they try any strong arm stuff—why, Slats'll bat their brains out, because they're just a couple of slob's an' Slats—he could have been a champion.' But then, of course, like I say, I didn't know your responsibilities, or think how it might look in the papers at Hasty Oak, or with your girl friend's old man at the bank—so forget it."

Slattery stood up. "I'm sorry," he said. "Look, Doc—do you need any dough?"

"Me? I've got a hundred irons in fifty fires. Why would I need dough? 'The Vikings' almost ready to challenge the Champ—soon as his hand gets better."

"Tell me more."

"Well, either the Champ, or maybe his wife," Doc said. "I'm not sure which. Dolly, take Slats downstairs an' make sure no bad men molest him. He's got a date to go to the opera with some very high-class friends."

"Lay off him, won't you?" Dolly shouted in sudden anguish. "Can't you leave him alone? Must you be so cruel?"

She wasn't a girl whom Slattery found easy to understand. She sobbed once, raising her hands to her face, and the best pair of shoulders in New York began to tremble in clear view. It was the first and only time that he had ever seen Dolly cry.

THEY sat well forward in the orchestra, just off the aisle—Thelma, Slattery and Mr. Travers. The musicians were assembled in the vast pit. There were more musicians, Slattery supposed, than he had ever seen in a Fifth Avenue parade.

"These are excellent seats," Mr. Travers said.

"I'm glad you like them, sir."

"Here's your libretto, George." Mr. Travers passed a grey paper folio to Slattery. "It would be difficult for you to follow things without one. And the flashlight, of course."

"Thank you."

Mr. Travers had demonstrated at dinner how to illuminate one's lap with this shaded flash that cast no glow into your own or your neighbor's face. *There's no reason why I shouldn't relax and enjoy it*, Slattery told himself. He was susceptible to music on the grand scale. Large concert bands in public parks had often moved his scalp and shrunk his skin and filled him with a hurting happiness. He watched the conductor appear, then bow once, leaning into the applause with pleasing dignity. The lights grew dim and Slattery felt the tension and high expectancy. He turned to Thelma.

"I'm anxious to hear the overture," he said.

"There is no overture to *Otello*," Mr. Travers corrected him. "Verdi saw no reason for writing one."

AEC REPRINTS ARTICLE

The Elks Magazine was gratified to receive recently from the United States Atomic Energy Commission a copy of the twelve-page reprint which this organization made of the article, "What the Attorney General's List Means," by Francis J. McNamara, that appeared in the November issue. The article was prepared by the AEC for use in connection with security educational activities at Oak Ridge.

"Really, George," Thelma said.

He sat there, seeking a fit reply, then had all minor worries blasted from his head. The few tremendous bars that paint the tempest's fury as the curtain rises on *Otello* were an aesthetic shock for which he had not come prepared. His fingers trembled as, a bit self-consciously, he applied his flashlight to the libretto in his lap. The drama progressed and there was much he found familiar

This Iago, he observed, this villain of the piece, this 18-carat heel he remembered now from high school, through the courtesy of William Shakespeare (it was the same play, really, set to music); it was odd how much his strutting and sneering and his slick, evil ways resembled the every day malevolence of Arthur Krugman. You almost expected to see Henny Sherman and Angel O'Hare come marching out of the wings.

"George," Thelma said at first intermission, "I was watching you. You looked so absorbed."

"It's a good show," Slattery said. "I like it."

"Do you like to like it so grimly?"

"Well, you know how I am. I get emotional when the music swells up like a mountain. It's a strange, unexplainable side of me. Sometimes I feel like I might take off."

Thelma stared at him apprehensively.

It occurred to Slattery in the second act that *Otello*, the noble Moor, looked very much like Archie Moore when he was a lighthavyweight. They had the same chin whiskers and majestic ways. A man of character and passion, poor *Otello* was a perfect chump for *Iago's* slimy schemes. But you did not get an impression that *Otello*, fool that he was, lacked determination in the face of trial. This noble Moor, if he played a shoe box scene, would still be the "Lion of Venice." He would never be a self-preserving sheep.

A feeling of shame crept over Slattery. *You take this Arthur Krugman, he was thinking; Shakespeare, Verdi or the F.B.I. could not describe a crueller, more covetous man. An aria soared while Slattery's self-esteem sank low. Doc, he decided, put his faith in me. Doc, like Otello, had a hole in his head. I've got to go to Arthur's place. I've got to go there now.*

"A cigarette, lad?"

"No, thank you," Slattery said. Mr.

Travers was enjoying a reflective smoke in the gentlemen's lounge. Thelma had gone to a powder room. "Tell me something," Mr. Travers said, "are you really in any distress?"

"Yes, sir," Slattery said. He decided that now was the time. "Would you think it was strange if I left here now and asked you and Thelma to meet me back at the Hotel Paradise? When the opera's over, I mean. Could you explain it to Thelma, sir?"

"I don't mind telling you I would think it was very peculiar," Mr. Travers said. "I'm not refusing, understand, but—well, is there anything in your background we don't know about?"

"I'll see you—eleven-fifteen—at the Paradise," Slattery said.

THE cash clientele were three-deep at the bar when Slattery entered Arthur Krugman's place. He maneuvered his way through the press of people. He saw few familiar faces. It was not a problem, however, to discover the alert, watchful countenance of Angel O'Hare, whose dimensions raised him well above the crowd. Slattery and Angel struggled with mutual eagerness toward one another. Only a waiter, with four steak sandwiches arrayed on one extended arm, was between them. The waiter went his skilled, professional way.

"Slatsy," Angel said, "lemme buy y' a beer for bein' such a gentleman this afternoon. No hard feelin's?"

"No hard feeling's at all," said Slattery.

He hit Angel in the maturing waistline with the kind of short left hook that makes the sawdust groan in heavy punching bags. It was done with such swift economy that a passerby would not think Angel had been slugged at all, but rather that the big man, gagging and fighting for his breath, had unwisely swallowed a knife, a fork and a spoon. Slattery spun Angel around, engaging his arms as though to assist him, then said to the same returning waiter, "This man is sick. Is Arthur Krugman in his office?"

"Upstairs, one flight," the perspiring waiter said.

"Nice and easy, Angel," Slattery instructed. "Take a deep breath—slowly, one, two—inhalé—up the stairs. Make one wrong move and I will beat your brains out on the bannisters." He tightened his grip on Angel's arms until the gasping man obliged. They ascended slowly. OFFICE it said on one of the doors. The door was unlatched and Slattery opened it, releasing Angel, whose free hands sought his own stomach. Slattery, with a gesture equal to the Grand Opera determination within him, locked the door with a wrenching turn of the protruding key.

"Hello, Arthur," he said. "Remember me?"

Arthur Krugman was a modestly constructed, dapper villain of middle age. As an old flesh dealer whom the fight game had rewarded for his sins, he had prospered even more extravagantly in the food and whiskey trade. He was not a thief to be taken lightly.

"Iago—I mean, Arthur," Slattery said.

"I want the dough. Ten thousand, two hundred and fifty-four clams. Get it up."

"Henny," said Arthur.

Henny Sherman looked nervous but willing. Angel O'Hare, taking one last draught of air, unleashed a right-handed punch that might have decapitated a brass cow, had it landed. Slattery stepped in, planting another left hook in the area he had bombed before. This time Angel sank the total distance to the floor.

"I keep forgetting I have a special talent it would be a shame to waste," said Slattery.

He spoke too soon. The next thing he knew he was seated on the floor. His head buzzed like a dropped clock. He looked up. Henny Sherman smiled in triumph. Slattery attempted to rise, but Henny kicked at his head with the earnestness of a man attempting the *point-after-touch-down*. Slattery caught Henny's foot both in the eye and in the grip of his clutching hands. Lights and sounds erupted in his head, but he held on, twisting Henny's leg until he had unbalanced him. They both got up and Slattery began to fight with few, if any, gentlemanly inhibitions.

FREE 30 DAYS SUPPLY
Safe High Potency Nutritional Formula
VITAMINS
MINERALS and AMINO ACID



25 proven ingredients - 11 vitamins (including blood-building B-12 and folic acid), 11 minerals, choline, inositol and methionine

Yes, we'll send you this \$5.00 supply free to prove how much healthier and peppier you may feel after a few days' trial! We'll also send details of an amazing new plan that provides a full supply of vitamins every month for just \$2.00! You're not obligated to buy from us now or ever. Mail coupon now!

EACH DAILY C.F. CAPSULE CONTAINS
Vitamin A 12,500 USP Units
Vitamin D 1,500 USP Units
Vitamin C 75 mg.
Vitamin B-1 5 mg.
Vitamin B-2 2.5 mg.
Vitamin B-6 0.5 mg.
Vitamin B-12 1 mcg.
Niacin Amide 40 mg.
Calcium Pantothenate 4 mg.
Vitamin E 2 I.U.
Folic Acid 0.5 mg.
Plus 11 minerals, choline, inositol and methionine.

Mail Coupon Now!
VITASAFE CORP., 43 W. 61st St., New York 23, N. Y. 88-2A
Please send free trial vitamins and details of new Plan which I will accept or reject. I am not obligated to buy anything. (I enclose 25c for packing and postage.)
Name.....
Address.....
City, Zone, State.....
Only one trial supply per family.

Law!
STUDY AT HOME

We guide you step by step—furnish all text material, including 14-volume Law Library. Training prepared by leading law professors and given by members of the bar. Degree of LL.B. Low cost, easy terms. Send for valuable Free Book, "Law Training for Leadership," today.

LaSalle Extension University, Dept. 3328L
A Correspondence Institution Chicago 5, Ill.

REAL ESTATE
BE A BROKER

PAYS BIG! SEND FOR FREE, BIG, ILLUSTRATED CATALOG NOW! Graduates report making substantial incomes. Start and run your own business quickly. Men, women of all ages, learn easily. Course covers Sales, Property Management, Appraising, Loans, Mortgages, and related subjects. **STUDY AT HOME** or in classrooms in leading cities. Diploma awarded. Write TODAY for free book! No obligation. Approved for World War II and Korean Veterans

WEAVER SCHOOL OF REAL ESTATE (Est. 1936)
2020H Grand Avenue Kansas City, Mo.

FREE BOOK TELLS HOW

\$7.95 **DRAINS** cellars, cisterns, wash tubs; **IRRIGATES - CIRCULATES - SPRAYS**



Type P Pump has 1,001 uses. Up to 3,000 GPH; 450 GPH 80' high; or 1,800 GPH from 25' well. Use 1/6 to 3/4 HP motor. Coupling included free. 1" inlet; 3/4" outlet. Stainless shaft. Won't rust or clog. . . . \$7.95

Heavy Duty Ball-Bearing Pump. Up to 7,500 GPH. 1 1/4" inlet; 1" outlet. \$12.95 Postpaid if cash with order. Send for yours today. Money Back Guarantee.

LABAWCO PUMPS, Belle Mead 58, N. J.

QUICKLY FOLD OR UNFOLD FOR CHANGING ROOM USES

Mitchell FOLD-O-LEG tables



TOPS OF MASONITE PRESHWOOD • FIR & BIRCH PLYWOOD • LINOLEUM • PLASTICS

MAXIMUM SEATING MINIMUM STORAGE

STRONG, RIGID TUBULAR STEEL LEGS

Send for folder with complete specifications.
MITCHELL MANUFACTURING CO.
2748 S. 34th St., Milwaukee 46, Wis., Dept. G

This prize bull calf from the Mayo Wood Herd in Minnesota was on its way to join the famous herd on the farm of the Elks National Home in Bedford, Virginia, when this photograph was taken. From left, Dr. James E. Trost, Exalted Ruler of Rochester Lodge, L. R. Benson, Vice President, Minnesota State Elks Association, and Past Grand Exalted Ruler Sam Stern, who donated the calf to the farm at the Home.



If Ruptured Try This Out

Modern Protection Provides Great
Comfort and Holding Security

Without Torturous Truss Wearing

An "eye-opening" revelation in sensible and comfortable reducible rupture protection may be yours for the asking, without cost or obligation. Simply send name and address to William S. Rice, Inc., Dept. 13F, Adams, N. Y., and full details of the new and different Rice Method will be sent you free. Without hard flesh-gouging pads or tormenting pressure, here's a Support that has brought joy and comfort to thousands—by releasing them from Trusses with springs and straps that bind and cut. Designed to securely hold a rupture up and in where it belongs and yet give freedom of body and genuine comfort. For full information—write today!



The BALL CLINIC

THE BALL HEALTH SCHOOL, INC.
Dept. 759 EXCELSIOR SPRINGS, MISSOURI
Specializing since 1919 in the treatment of Rheumatism, Arthritis and associated chronic conditions
WRITE FOR FREE BOOK TODAY!

FREE FOR ASTHMA

If you suffer asthma attacks, choke and wheeze, and sleep impossible because of the struggle to breathe, try FRONTIER ASTHMA MEDICINE now! Get immediate, blessed relief from the dreaded symptoms of bronchial asthma. Over 1,000,000 bottles sold. FREE TRIAL bottle by return mail. You pay nothing. Send name and address now to: FRONTIER ASTHMA CO. 611-A Frontier Bldg., 462 Niagara Street, Buffalo 1, N. Y.

STOP Skin Torment

Very first use of soothing, cooling liquid D. D. D. Prescription positively relieves raw red itch—caused by eczema, rashes, scalp irritation, chafing—other itch troubles. Greaseless, stainless. 45c trial bottle must satisfy or money back. Ask your druggist for D. D. D. PRESCRIPTION.

Do FALSE TEETH Rock, Slide or Slip?

FASTEETH, an improved powder to be sprinkled on upper or lower plates, holds false teeth more firmly in place. Do not slide, slip or rock. No gummy, gooey, pasty taste or feeling. FASTEETH is alkaline (non-acid). Does not sour. Checks "plate odor" (denture breath). Get FASTEETH at any drug counter.

REMOVE CALLUSES

CORNS quickly

HOLLIS
SAFE
WAY

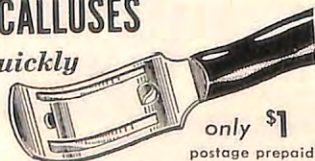

only \$1
postage prepaid

Scientific speed trimmer EASY AS SHAVING!
Just glide blade surface, callus or corn "peels" off.
No pressure! No pain! No preliminary soaking!
Don't cut into your callus or corn and risk blood poisoning and other infections. Use Safe Way with blade encased in safety shell to protect skin.
Accident-proof... quick, easy, absolutely safe:
Uses regular double-edged blade—easy to clean, easy to replace. Precision made of chromium plated surgical steel... colorful hand-shaped handle.
Guaranteed to Satisfy or Money Back.
HOLLIS Co. 1133 Bway, New York 10, Dept. C-34

It was comforting the way it all came back to him. He felt, as Henny Sherman collapsed, that Doc would have been pleased.

"Arthur," he said. "Whether that is your gun or Henny's, I want you to put it back in the drawer, or stick it in your ear."

"Why should I?" Arthur Krugman said. "Because half the town knows that I'm here, and why I'm here," said Slattery, abusing the truth a little more than Bobo McBride might have dared. "Now the real question, Arthur, is this—do you want to count out that money? Or do you want me to heave you through the window into 47th Street?"

Slattery advanced with a slow, determined stride. Angel O'Hare remained spread-legged and disillusioned on the floor. Henny Sherman would be no practical help.

"Listen, I can count money better than you can," Arthur Krugman said. "Stay where you are."

SLATTERY, walking east again, wondered if such a sum of money had ever before been wrapped in a menu. It bulged the inside pocket of his suit as he strode fearlessly past the parking lot on 47th Street. He stopped once beside the window of a liquor store to take off his hat and comb his hair. He straightened his tie as best he could, then walked a few doors further east to examine his eye in the mirror of a gum-vending machine. He shook his head a bit sadly now. The eye was really a beaut.

Thelma and her father were not yet due at the Hotel Paradise. The clock in the lobby said 11:00. Slattery was wondering how, with an eye like this, he could bolster his social poise, when he saw Willy "The Blood Bank" Shapiro.

"That must of been some opera," Willy said. "Who hit you the sucker punch?"

"A southpaw soprano," Slattery said. "Is Doc upstairs? I've got a little something here I think he could use."

"He's in the bar with Dolly, talkin' to the manager. They want to drum up a job for Bobo McBride." Then Willy's expression began to glow. "Hey, wait a minute, Slats. You've got the bundle?"

"I didn't go over to Krugman's place for a short beer," Slattery said.

WHAT he would remember most from the evening was sitting in the cocktail lounge with Dolly when her noisy uncle had departed. As an old man of twenty-eight, he wondered if it were a proper thing to be sitting here in stunned enchantment with a child of twenty-one. The first time their hands met was by accident, in a bowl containing cheese-bits.

"Excuse me," he said, a little nervously. "It's all right, Slats." And Dolly smiled.

"You know, we all grow up a little bit," she said. "I wouldn't want to see you get slugged like this as a regular thing, except that it looks so natural. I'm not sorry you're in the doll business, Slats. I

General Gruenther Writes to Grand Exalted Ruler

In appreciation of the appeal that Grand Exalted Ruler Fred L. Bohn made to the Order to support the Red Cross drive for money for the relief of Hungarian patriots, General Alfred M. Gruenther, President of the American Red Cross, wrote this letter to Mr. Bohn:

"I want you to know that I greatly appreciate your cordial and prompt response to our request for your endorsement of the 1957 Red Cross Campaign for Members and Funds.

Your message affirming your belief in the significance of Red Cross services to people of the nation is gratifying to me, and will certainly serve to inspire our volunteer leaders and workers throughout the country.

We are deeply grateful for your continuing interest and support."

don't really think it's very disgraceful."

He could never remember all of the other, unimportant things they said. Once Dolly touched his ballooned brow with a gentle hand, as though such tender ministrations were a personal, patented thing. No other hand had ever felt the same.

"What is she like, Slats?" Dolly said. "Who?"

"The girl you took to the opera, of course."

Slattery, a conscientious fellow, groaned aloud. *Thelma*, he thought, *and Thelma's old man*. "Excuse me," he said, then rushed outside. The clock in the lobby said 11:42. Doc, Willy and Bobo McBride were standing together, watching him carefully.

"What's the matter, boy?" Doc said.

"I was supposed to meet some people here at eleven-fifteen."

"You mean the old guy in the Homburg hat? An' the tall, good-lookin' dish? They were here, Slats," Doc explained, "about a half hour ago. I told them you were inside at the bar. They took one look at you an' Dolly, then decided not to wait."

"Oh," said Slattery. "I see." But the blow fell lightly. He certainly hoped he hadn't offended them. He even wondered if Mr. Travers would prove uncordial at the bank. "Did they say anything?"

"The old man said that you can swim back over the Hudson, as far as he's concerned. Look, Slats—about that dough."

"What dough?"

"Let's not be cute," Doc said. "Ol' friends like you and me? I appreciate everything, boy, except that you didn't give it to me yet, an' I would like to buy champagne."

"You can't afford champagne," said Slattery, "because, whether you know it or not, you scheming bum, you're in the doll manufacturing business now."

And Slattery, a contented man, returned to the cocktail lounge.

In the Doghouse

(Continued from page 24)

ble coats, the long wiry outercoat or the long softer outercoat and the usually dense but softer undercoat. Some few of these will be found with no undercoat and with some of the terriers that have to be stripped or plucked this presents no small problem to the person who is grooming the dog.

THERE are a half dozen varieties of ears among our four-legged friends, beginning with the bat ear, which is an upright ear rounded at the top, as seen in the French bulldog; the rose ear of the bulldog (English variety), an ear that folds partly backwards so some of the inside of the ear can be seen from the front; the prick ear which is held sharply erect; the button ear that folds forward as it should with certain of the terriers, the Welsh, the fox terrier and similar breeds; and the semi-prick



CORRECTION: In the small map above we return Saudi Arabia and Iraq to the proper places from which they were omitted in the map that ran in connection with the article "Near East—What Is Behind The Israeli-Arab Conflict?" in our February issue. For reasons that no one can understand, we had Iraq where Saudi Arabia should be and Iran usurping Iraq's territory.

ear such as carried by the collie, partly erect but folded near the top.

When it comes to the tail, Towser goes to town. (Where did that name Towser originate, I never knew a dog so named, did you? Nor did I ever know one named Fido, although that name has reason for being since it is derived from the Latin *fidus Achates*, faithful Achates; a trusty friend.) There are no less than eight terms descriptive of dog tails.

The most noticeable feature of all dogs is color. One of the rarest colors among animals is blue and this is true of the dog to a marked degree. The only blue dog is the Kerry blue terrier, an Irish dog, and even that fellow isn't a true blue but rather more of a slate or dark lilac. Incidentally, some breeds change color as they grow to maturity. Kerry pups are born black and as they grow black turns to the shades mentioned previously. Airedale pups also come into this world black and later the tan markings appear. This breed, as you very likely know, when past the puppy stage is black and tan, or grizzle and tan. Dalmations, those dogs of which Mark Twain said he couldn't be sure whether they were white with black spots or black with white spots, as puppies are solid white and the spots, either black or sometimes tan, appear as the pups grow older.

Since there are more than one hundred technical terms used among the breeders of dogs, I'll not try to give all of them here but have endeavored to single out those which you may from time to time hear. To others seriously concerned with dogs (breeders, handlers, trainers and judges) many designations among the more than the hundred listed are so technical that they would be meaningless to the average dog owner.

As written earlier, I didn't know where this article was going or where it would end, but had an idea that I probably would "box the compass" in dogdom, covering a multitude of subjects, but now I find I've ended with the same topic I began—the matter of technical terms relating to our *fidus Achates*, our trusty friend—the dog.

A REUNION FOR A TRIO OF ELK PRINTERS

At the 98th Convention of the International Typographical Union in Colorado Springs, these Elks got together to compare notes. Left to right: 83-year-old Parker Worth, Honorary Life Member of Springfield, Mass., Lodge; Holyoke, Mass., Elk Jeremiah Geran, local Union Pres., and Hubert B. Royce of Reno, Nev., Lodge. Mr. Worth and Mr. Royce were in Springfield 40 years ago and had not seen each other again until they met at the Union's Home where both men now reside.



GOOD-BYE TO TUMMY BULGE!

I FEEL LIKE A KID AGAIN!



CHANGE YOUR APPEARANCE INSTANTLY!

In Seconds get rid of your ugly "Bay Window" appearance that makes people call you "Old Timer" and gives you that tired, dragged-down feeling. Now, when you wear the Amazing Cadet you'll appear more youthful, your clothes will fit again. Forget bursting seams and buttons popping off. Exclusive Power Panel assures perfect fit. Remove pouch for comfort and convenience.

Amazing POWER PANEL

FEATURES:

- Non-rolling
- Fly front
- Removable elastic pouch
- Finest firm-control elastic
- Under straps for comfort

6 MONTH UNCONDITIONAL GUARANTEE

Magic Mold Inc., Dept. C18C
467 Livonia Ave., Brooklyn 7, New York

Rush to me on your 6 MONTH GUARANTEE A Cadet Health Belt. I will pay postman \$3.98 (plus Postage). If not entirely satisfied I will return Cadet for full refund of purchase price.

My waist measure is _____ (send string size of waist if no measure is handy)

Send me _____ extra pouches at 75¢ each

Name _____

Address _____

City _____ Zone _____ State _____

SAVE MONEY: Enclose payment and we pay postage. Same money back guarantee.

\$3.98

Waist sizes 26" - 46"
Extra pouches, for convenience and comfort only 75¢ each

GET RELIEF FROM MISERY!

RED INDIAN OINTMENT gives temporary relief from aches & pains of arthritis, rheumatism, neuritis, lumbago, muscular aches, sprains, and lack of circulation. Money back guarantee.

David O. Kruger, Dept. E-3,
125 So. La Brea, Los Angeles 36, Calif.



\$1.00 only ppd. check or m.o.

People 60 to 80: Tear Out This Ad

... and mail it today to find out how you can still apply for a \$1,000 life insurance policy to help take care of final expenses without burdening your family.

You handle the entire transaction by mail with OLD AMERICAN of KANSAS CITY. No obligation. No one will call on you!

Write today, simply giving your name, address and age. Mail to Old American Ins. Co., 1 West 9th, Dept. L355M, Kansas City, Mo.

Elks



WORKSHOP

How to Plan and Make Built-in Furniture.

BY HARRY WALTON

FEATURED in many new homes, built-in furniture can also be the custom-made solution to living problems in older houses. When well planned, it can fit the available space and meet special needs better than ready-made pieces.

A built-in will usually take up less room than a separate unit of equal utility. Because the room walls form part of it, it requires less material. Being fastened to the walls, it takes its rigidity from them and can be built quite simply. You should find built-ins easier to make than self-standing pieces.

Sketch Out Your Idea before buying lumber. If in doubt of your ability to draw it, take a photo of the wall or corner it is to go in. Clip tracing paper over the picture and pencil in your built-in. If it goes wrong, or if you want to try other designs, simply replace the tracing paper.

Don't guess about heights. Check them against similar pieces that you find satisfactory. A kitchen counter top should be

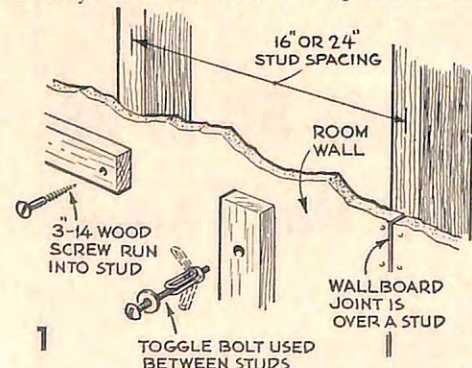

about 36" high, whereas a writing desk should be only 30" and a vanity 28". A bookshelf or corner cabinet, on the other hand, may go clear to the ceiling.

When such a piece is built somewhat short of the ceiling, the top will be a dust catcher. This space is therefore best closed off with a frieze or a face board, or if big enough, with small doors, which will form a storage space.

At floor level, a toe space about 3" deep,

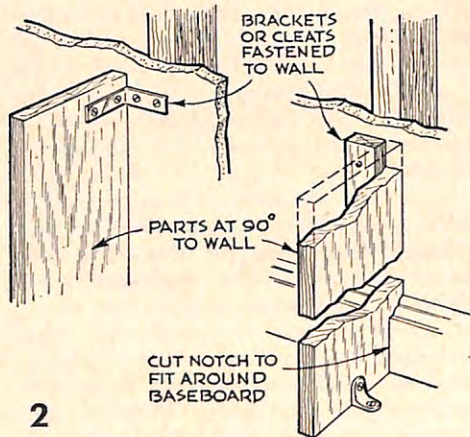

and slightly higher, must be provided under work surfaces, such as kitchen floor cabinets. Without this, the user will find it awkward to stand near such pieces. Sit-down work surfaces like vanities and desks will not be comfortable unless you leave ample knee space under them.

Bookshelves should be at least 7½" deep (the shelves can be 8" boards). For outsize volumes, you may want one or more still wider shelves—usually the lower ones.

Save Yourself Effort by making shelves, sides and as many other parts as possible the width of stock lumber. You will have to rip some parts to width anyway, but forethought can minimize this labor. Remember that boards are actually about ⅜" narrower than their nominal width—a 6" board is 5⅝" wide, an 8" board about 7⅝".

Another way to save construction time is to use ¾" plywood. This requires no framing under it, and is so thick that

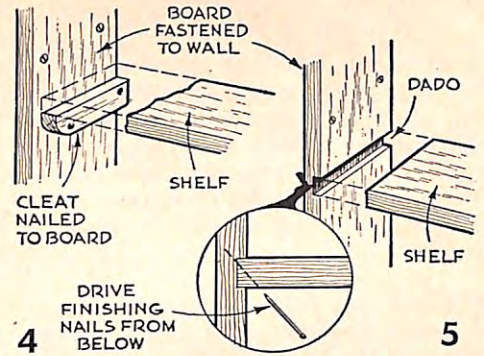
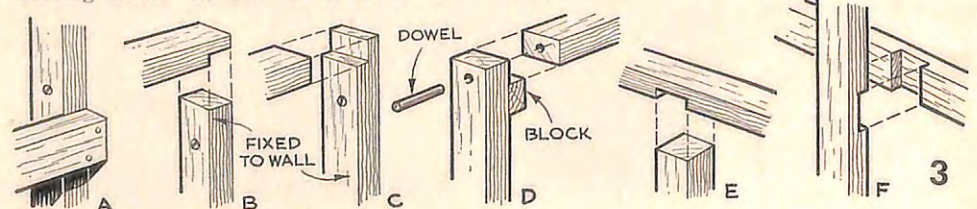

pieces can be joined directly at corners if you wish, although angle brackets or cleats will make for still stronger construction.

However, it may cost less to build a framework of two-by-two or lighter lumber and enclose this with ¼" or ⅜" thick plywood. Since the framework is hidden, it can be made of a cheap grade of wood. For a period effect, you can use tongue-and-groove wall paneling instead of plywood. This comes in knotty pine, cypress or redwood and takes a beautiful natural finish.

Fastening parts to walls. A horizontal member can usually be screwed directly to two or more studs (the wooden uprights in a wall). Draw a line on the wall where the piece is to go. Then drive a thin nail (or use a 3/32" drill) at intervals along this line. When the nail or drill bites into wood instead of breaking through the plaster or wallboard, you've found a stud.

Studs are usually spaced either 16" or 24" apart from center to center, as shown in Figure 1. If you can see the joints in wallboard, you'll find studs under them. If not, you'll have to locate them by trial and error as suggested above.

Once the studs are found, you can nail or screw the wall members of your built-in to them (Figure 1). Screws are preferable, as nailing may damage plaster elsewhere on the wall, or even in the next room.

Sometimes the part to be mounted will not lie over any stud. To fasten it directly to a plaster or plasterboard wall, use toggle bolts or screw anchors, both of which lock themselves inside the wall. (See *The Elks Workshop*, December, 1954.) In brick or concrete-block walls, use lead expansion shields with wood or lag screws.

A piece that is to be fastened at right angles to the wall will have to be attached to a cleat or an angle bracket, and this in turn fastened to the wall by one of the means described, as shown in Figure 2. To fit such a piece closely against the wall, you will have to cut a notch in it to accommodate the baseboard, as shown in this drawing.

Parts can be screwed directly or with brackets to the floor or ceiling of a room

if need be. Avoid nailing to the ceiling. If the side members of a built-in are firmly attached to the room walls, it should not be necessary to fasten any part to the ceiling.

Joining the Framework. Once you have parts firmly fixed to a wall, you can fasten other members to them with a variety of joints. One may be nailed or screwed to an edge of the other as at A in Figure 3. The horizontal piece may be notched as at B and nailed on from the top, or the vertical post may be notched as at C and the horizontal rail laid into it.

An outside post (not screwed to a wall) may be joined by any of these methods or

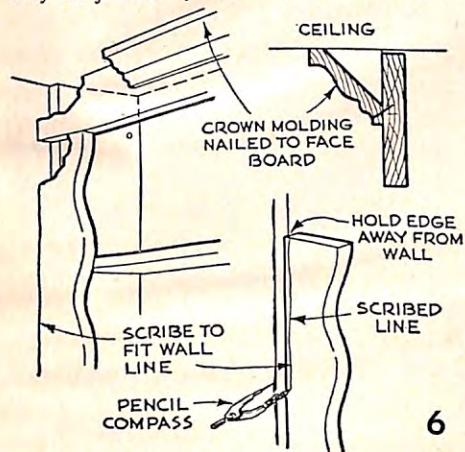

with a dowel as at D. Clamp or nail a block to the post to support the rail while you drill through both parts at once for one or two dowels. Where a piece runs across another, you can either make a simple butt joint, or notch the crossing member as at E. If both parts cross, a half-lap as at F makes a strong joint and keeps the surfaces of the two pieces flush.

How to Support Shelves. At the wall end, the shelves of a cabinet could be laid on cleats fastened to the walls. But since each cleat requires at least two fastenings, this method entails more work than does mounting a whole board on the wall. With the board in place, it is a simple matter to nail shelf cleats to it as in Figure 4.

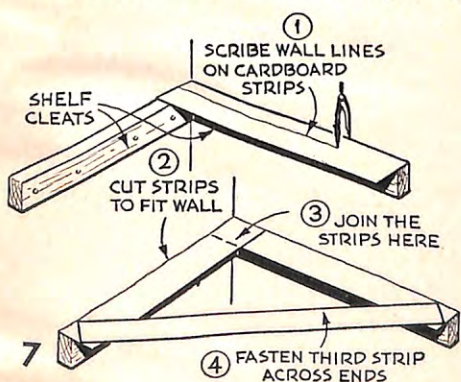

These cleats can be cut from one-by-two lumber or even from large molding.

A better way, however, is to cut dados (crosswise grooves) in the upright board to receive the shelves. This should of course be done before the board is put in position. If the shelves are toenailed from beneath, as shown in the detail in Figure 5, the nails will be inconspicuous.

Harry Walton made this window alcove in his home more usable with a full-width cabinet for huge storage space, plus a big shelf. Only the top is plywood. Doors were made of tongue-and-groove pine wall paneling.

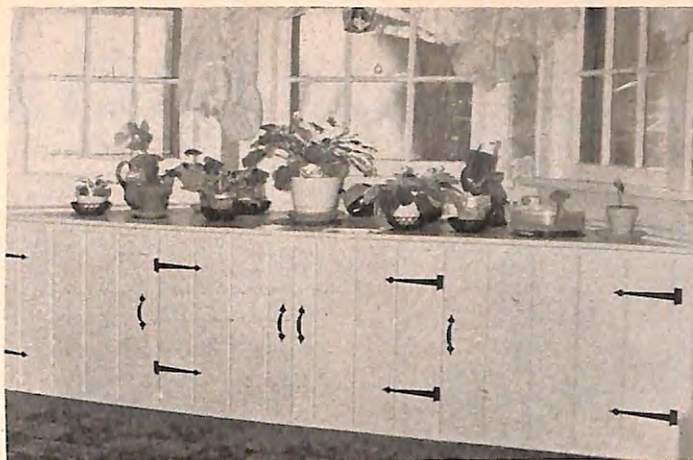

No Wall Is Straight. A truly flat, straight wall is a rarity. This becomes obvious when you want to fit a face board neatly against it, as in Figure 6. Irregularities in the wall surface leave gaps, and sometimes the slope of a wall will force the part visibly out of line. One way to cover up the trouble is to nail light molding along the gap. At a ceiling line, a cove or crown molding as shown in Figure 6 looks well.

But sometimes a piece must be fitted to the irregular wall line rather than alibied

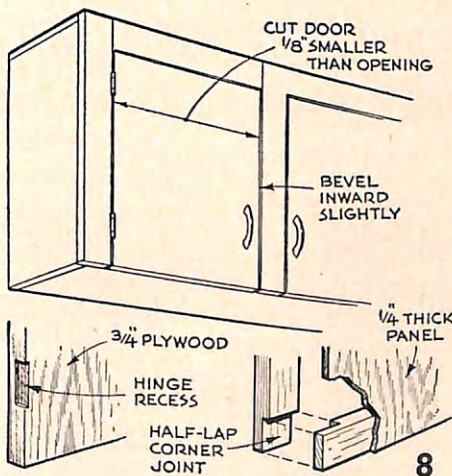

this way. Hold, clamp or tack the member an inch or so away from the wall, with the opposite edge truly vertical (or horizontal, if it is to go against the ceiling).

Set a pencil compass to the distance between the deepest wall hollow and the edge of the piece. Then, holding the compass at the same angle, run the point along the wall. The pencil will trace the wall contour along the piece. Use a coping saw or a rasp to work down to the scribed line.

A piece that must fit two walls, like a corner shelf, cannot well be scribed directly. Cut two strips of cardboard the length of the two edges of the piece. Thumbtack one at a time in position (on the shelf cleats, for example) and scribe them (Figure 7). Cut them carefully to the scribed lines, place them in position again, and tape or staple them together in the corner as shown.

Now staple a third strip, or tack a piece of wood, across the ends of the two strips. This will make them a rigid triangle,

which you can lift up and lay at top of the shelf stock. Run a pencil along the fitted cardboard edges to mark the wall contour on the wood, and cut or dress it to this shape.

Doors For Your Built-in. Flat, flush doors (which fit inside the door opening) have no dust-catching projections. To look well, however, they must be accurately fitted. Make them $\frac{1}{8}$ " smaller in each dimension, beveling the edge opposite the hinge edge slightly inward.

You can cut such doors from $\frac{3}{4}$ " plywood, or build a frame of one-by-two stock and cover it with thinner plywood or hard composition board. Figure 8 shows both methods. The hinges should be set into mortises. If the shelves do not keep the door from swinging too far inward, fasten small stop blocks inside.

Lip doors (Figure 9) overlap the door opening on all sides and protrude from the cabinet face by about $\frac{3}{8}$ ". You can make such doors by cutting a step or rabbet along all four edges of a piece $\frac{3}{4}$ " larger each way than the door opening. Another method is to build a frame as in Figure 8, but cut the panel $\frac{3}{4}$ " oversize each way. The result is shown in Figure 9. Round the lip off from the outside, leaving the inner corner sharp.

Lip doors should be mounted with offset hinges, which are very easy to install. The standard offset is $\frac{3}{8}$ ", so make your doors to fit. Hinge styles range from modern chrome-finished ones to simulated wrought-iron strap hinges. Handles and latches are available to match.

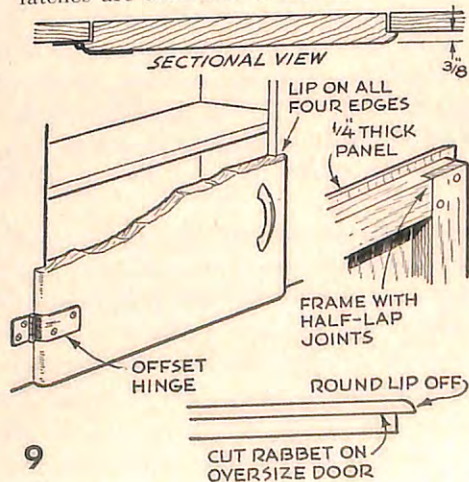

Editorial

TWO-THIRDS MARK



As Grand Exalted Ruler Bohn concludes two-thirds of his administration it is pleasing to us to take appreciative notice of the creditable manner in which the responsibilities of his office have been met.

When he assumed that office he appealed for "A Stronger Elkdom for a Better America." Unquestionably, he has contributed materially, personally, to making that pledge or suggestion a reality.

As a firm believer in the principles and purposes of our Order he has urged his fellow members to re-obligate themselves to Elkdom and he has set the example by his own dedication thereto.

As a business man he has a proper appreciation of the administrative responsibilities and possibilities of the office and has recognized a proper balance of values of the results to be accomplished at his headquarters desk and those resulting from visits to subordinate lodges and State Conventions.

He and the members of his staff have given prompt and comprehensive attention to the reports of his District Deputies on the conditions in nearly 1,800 lodges. He has acted promptly to correct conditions where such corrections have seemed necessary and to give commendation where commendation has been due.

As an experienced newspaper editor his monthly message in The Elks Magazine to the 1,200,000 members of the Order has been appropriate, educational and appealing.

As a civic leader in his community he has encouraged increased community service on the part of our lodges and their individual members.

As a loyal American, in his inaugural address, he vigorously condemned communism and he has as vigorously led the Order's fight against this evil threat to freedom throughout the world.

As a devout churchman he appealed to the members of the Order to rededicate themselves to God. He has "allured to higher worlds and led the way".

On his visits his cordial, friendly manner has won for him hosts of new friends and his sincere, forceful addresses have been a real inspiration to those assembled.

Having a full appreciation of the potentialities of the District Deputy system, his field force of 174, he has been leading them and directing them to a full realization of their responsibilities and their possibilities of accomplishment.

We have just had the privilege of reading his recent communication to the members of that field force and have been impressed by the forcefulness with which he has sought to strengthen the work of the district clinics and has impressed upon his Deputies the importance of building up our membership, support of the Elks National Foundation, our Youth Activities and, in short, the building of "A Stronger Elkdom for a Better America."

A REAL HOME



The Grand Exalted Ruler is to be commended for his proclamation making the month of January an Elks National Home month.

It is surprising what a small percentage of the members of the Order are informed relative to the characteristics and advantages of the Home.

Surely if such information were more generally possessed there would be a waiting list for admission to the Home instead of there being, as there are today, vacancies.

It is to be hoped that the article about the Home appearing in the January issue of The Elks Magazine will result in the material reduction in such vacancies.

The article stated that Superintendent Thomas J. Brady is a former member of the Board of Grand Trustees, implying that it naturally follows that his service on the Board is responsible for his success as manager.

We know that his experience as a Grand Trustee is not nearly as responsible for his success as is his possession of a full measure of the milk of human kindness and his understanding and deep interest in his fellows.

These are the qualities, shared in full measure by Mrs. Brady, that give the Home the characteristics that a real home should have. We are seeing many evidences of the deep appreciation that the members resident in the Home have of its thoughtful and kindly administration.

A GOOD LOSER

So many Elks each day are demonstrating the finer qualities of manhood that a magazine the size of The Elks Magazine would not have the space to recount all of them.

Occasionally, however, there comes to our attention an illustration of practically perfect graciousness displayed by a Brother of which we are impelled to take recognition, though refraining from disclosing the name or position of the Elk involved.

Let it suffice then to say that an Elk, holding a high public position, was defeated in the course of political events in a contest for an even higher public office. It fell to the responsibility of our defeated Brother to preside at the ceremony of installation of his successful opponent.

An able, experienced political observer and reporter had this to say of the manner in which our Brother handled the situation.

"He never faltered as he played his part. In firm voice he greeted each, including the man who in a brief few moments would grasp the gavel which he had wielded so well . . .

"And then he stood by to add his welcome to the man who defeated him . . .

"With rare dignity he performed that task, his deep voice reverberated throughout the chamber as he intoned the words which culminated the decision of the voters.

"When his task was done and the time came for him to step down and he turned his back upon the scenes of his political glory, he was given an ovation. It was a heart-warming moment.

"Applause swept the chamber as he bowed out of political life, for he was a valiant soldier. It was a tribute he well deserved."

* OFFICIAL ELK JEWELRY

A Gift That Will be Worn Proudly by Any Elk

For the lodge or the individual wanting to give an Elk a lasting gift that he will proudly wear here is the answer. Handsome jewelry officially approved by the Grand Lodge and distributed by The Elks Magazine. Prices include federal tax.



No. 1—50 year emblem. Beautiful, 10k gold with gold plated post and attaching button and five single cut sparkling 2-point genuine diamonds. Price \$78.85. A splendid gift to honored members or officers.
No. 1A—Same design, set with five blue sapphires. \$19.25.



No. 7E—Economic membership pin, without years designation, in 10k gold plate finish. \$4.00.

No. 7—Same design as above, in 10k solid gold, with gold plated post and attaching button. \$7.35.

No. 7S—Same as No. 7 but set with one 4-point genuine blue sapphire. \$11.00.

No. 7A—Same design with 2-point diamond. \$20.15.

No. 7B—Same design with 4-point full cut diamond. \$28.40.



No. 10—30-year membership, plain with no jewels. 10k gold with gold plated post and attaching button. \$8.25.

No. 10A—Same pin, same quality as No. 10 but set with one 1½-point blue sapphire. \$9.90.

No. 10B—Similar to above, set one 1½-point diamond. \$19.00.



No. 9—Life membership. Design similar to No. 8 but with word Honorary omitted. Same fine construction and enameling. \$9.15.

No. 9A—Exactly like life membership pin shown above but with three 2-point blue sapphires. \$13.75.

No. 9B—Same as No. 9. With three 2-point diamonds. \$49.50.



No. 2—Plain 50 year membership pin with no jewel but brilliantly enameled red, white and blue. 10k gold with gold plated post and attaching button. \$11.00.



No. 11—Past Exalted Ruler pin. An emblem of rare beauty for one who has distinguished himself in his lodge and among his Brother members. Same craftsmanship that makes official Elk pins such fine examples of jeweler's art. Clock and pin beautifully enameled red, white and blue. Past Exalted Ruler designation gold letters on blue background. \$12.50.

No. 11A—Same as above pin No. 11 but with 5-point diamond. \$46.00.

No. 11B—Similar to 11 and 11A but jewel is a 10-point diamond. \$70.00.



No. 8—Honorary life membership pin. 10k gold, gold plated post and attaching button. \$9.15.

No. 8A—Same design with three 2-point blue sapphires. \$13.75.

No. 8B—Same design with three 2-point diamonds. \$49.50.

* Registered designs of the B.P.O.E.

TM and © applied for.



No. 3—25 year membership, plain (no jewels) 10k gold with gold plated post and attaching button. Handsomely enameled red, white and blue. \$8.25.

All Pins Manufactured By L. G. Balfour Co., one of America's Leading Manufacturing Jewelers

THE ELKS MAGAZINE

386 Fourth Ave., New York 16, N. Y.

Enclosed is check for \$..... for emblem

Button No..... Quantity.....

Name.....

Street.....

City..... State.....

On N. Y. C. orders please add 3% Sales Tax.



"The Money-Saving Olson Rug Plan is just the thing for Newlyweds. I've never seen lovelier colors or patterns."



"It's Marvelous! We saved over \$60 on our new living room carpet by sending in our old rugs, carpets and clothing."



"I've always loved Olson Broadloom Rugs and now they are better than ever. The reversible feature is wonderful. Doubles the life of the rug."

Beautiful BROADLOOM CARPETS, RUGS for Far Less!



As Little as \$2 a Week

BROADLOOM Woven Reversible for Double Wear. Almost 1/2 inch thick.



© ORC.

When Guests arrive, you will be mighty proud of your Home and your beautiful new Olson Rugs

Picture this warm Grey Broadloom in your living room

All the new colors: Grey, Beige, Nutria, Cinnamon Taupe, Grey Green, Hunter Green, Red, Burgandy, Blue, Rose, Turquoise, Gold, Raisin

There is HIDDEN TREASURE Right In Your Own Home

Go on a "TREASURE HUNT" for Materials: worn Rugs, Carpets, Clothing, Blankets, etc. They are valuable! Smart Homemakers Never Let Good Materials Go to Waste. A few minutes of your time . . .

. . . Can Save You Many Dollars on . . .

luxurious, new Rugs or wall-to-wall Carpeting

IT'S ALL SO EASY—LIKE MAGIC—Why not write today for the big, beautiful, Free Olson Rug and Carpet Catalog and Decorating Guide in actual colors that tells how . . .

The Valuable Material in your Old Rugs, Carpets, Clothing, etc., is scientifically reclaimed like new, sterilized, shredded, merged, pickered, bleached, blended with choice New Carpet Wools, then redyed with the finest dyes, respun into yarn, and woven *In a Week* into luxurious, new, deeper-textured Olson Reversible Broadloom Rugs or wall-to-wall Carpeting—lovely enough for even the finest homes.

Choice of 44 up-to-date colors, patterns regardless of the colors in your materials; any size, seamless up to 18 ft. wide, any length.

Solid Colors	Embossed Effects	Scroll
Tweed Blends	Early American	Florals
Tone on Tone	Oriental Patterns	Ovals

Factory-to-You. We pay Express or Freight on your materials from any state. We Guarantee to please or pay for your material. Over 3 million customers. Our 83rd Year



No Other Rugs or Carpeting OFFER SO MUCH for SO LITTLE!

It stands to reason that where you furnish so much of the material, you get a better rug for far less money. There is 33 to 50 per cent more material in an Olson Rug than most one-sided rugs anywhere near the price. For example, 12 x 15 ft. Olson Rug weighs 77 lbs., not 50 or 55. Why pay for costly materials when you have so much material of your own—more than you realize. Let "OLSON RUG MAGIC" save you up to 1/2.

OLSON RUGS and Wall-to-Wall CARPETING

Tear Out Now ↓ MAIL COUPON OR POSTCARD TO ANY ADDRESS BELOW

FREE Catalog, Decorating Guide

EVEN IF YOU HAVE NO OLD MATERIAL TO SEND— . . . write for the NEW Olson Rug Book with model rooms—in full color. Olson Reversible Rugs are so beautiful and durable that many with no materials BUY OLSON BROADLOOM OUTRIGHT at Factory Prices.

Name.....
Address.....
City.....State.....

OLSON RUG CO., Dept. F-43
CHICAGO 41, ILL. | NEW YORK 1, N.Y. | SAN FRANCISCO 8,
2800 N. Pulaski | 15 W. 34th Street | 209 Post Street